

SERVICE MANUAL

E175C Crawler Excavator

Part number 47494131A
English
February 2013





SERVICE MANUAL

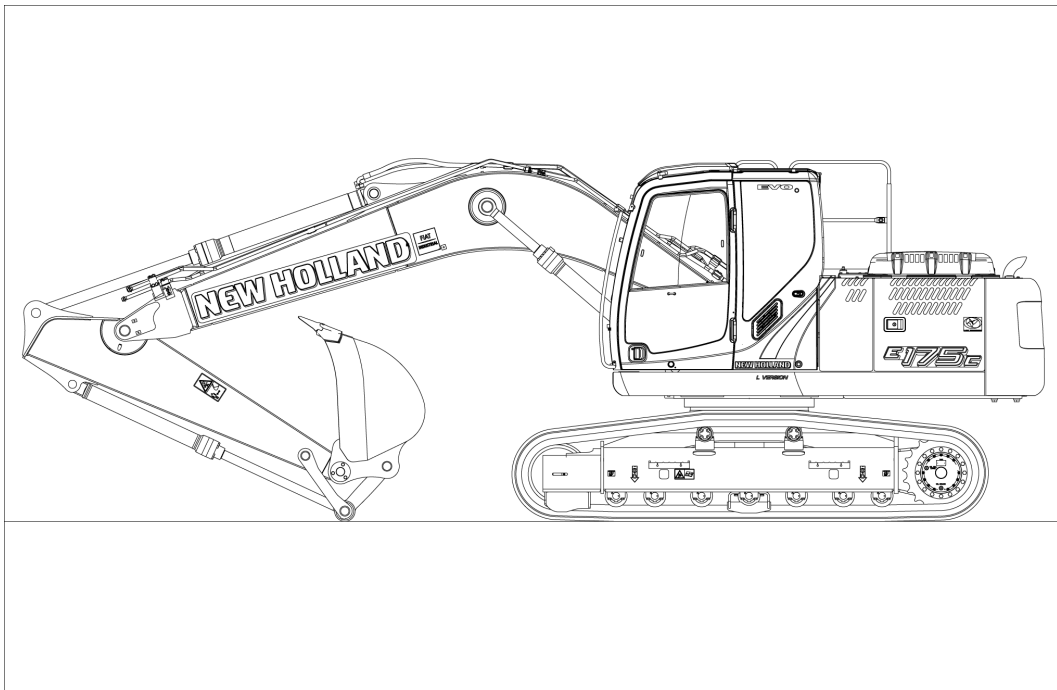

E175C

Contents

INTRODUCTION

Engine.....	10
[10.001] Engine and crankcase	10.1
[10.202] Air cleaners and lines	10.2
[10.216] Fuel tanks	10.3
[10.254] Intake and exhaust manifolds and muffler	10.4
[10.400] Engine cooling system	10.5
Hydraulic systems.....	35
[35.000] Hydraulic systems.....	35.1
[35.102] Pump control valves.....	35.2
[35.106] Variable displacement pump	35.3
[35.300] Reservoir, cooler, and filters.....	35.4
[35.352] Hydraulic swing system	35.5
[35.353] Hydraulic travel system	35.6
[35.354] Hydraulic central joint	35.7
[35.355] Hydraulic hand control	35.8
[35.356] Hydraulic foot control.....	35.9
[35.359] Main control valve.....	35.10
[35.736] Boom hydraulic system	35.11
[35.737] Dipper hydraulic system.....	35.12
[35.738] Excavator and backhoe bucket hydraulic system.....	35.13
Frames and ballasting	39
[39.101] Upper frame.....	39.1
[39.103] Swing ring assembly	39.2
[39.140] Ballasts and supports	39.3
Tracks and track suspension	48
[48.100] Tracks	48.1

[48.130] Track frame and driving wheels	48.2
[48.134] Track tension units	48.3
[48.138] Track rollers	48.4
Cab climate control	50
[50.200] Air conditioning.....	50.1
Electrical systems	55
[55.000] Electrical system	55.1
[55.015] Engine control system.....	55.2
[55.036] Hydraulic system control	55.3
[55.051] Cab Heating, Ventilation, and Air-Conditioning (HVAC) controls.....	55.4
[55.100] Harnesses and connectors.....	55.5
[55.302] Battery.....	55.6
[55.640] Electronic modules	55.7
[55.DTC] FAULT CODES.....	55.8
Booms, dippers, and buckets	84
[84.100] Bucket.....	84.1
[84.910] Boom	84.2
Platform, cab, bodywork, and decals	90
[90.105] Machine shields and guards	90.1
[90.116] Fenders and guards.....	90.2
[90.124] Pneumatically-adjusted operator seat.....	90.3
[90.150] Cab.....	90.4



INTRODUCTION

Contents

INTRODUCTION

Safety rules	3
Personal safety	4
Torque	13
Basic instructions - Important notice regarding equipment servicing	22
Basic instructions - How to use the maintenance standard and precautions	23
Basic instructions - Preparation for performance tests	25
Basic instructions - Precaution for disassembly and assembly	26
Basic instructions - Installing hydraulic equipment	28
Basic instructions - Electrical equipment precautions	31
Capacities - Fluids and lubricants	32
Hydraulic contamination	34
Product identification - Machine Orientation (front, right, rear, left)	35
Product identification	36

Safety rules

Personal safety





This is the safety alert symbol. It is used to alert you to potential personal injury hazards. Obey all safety messages that follow this symbol to avoid possible death or injury.

Throughout this manual you will find the signal words DANGER, WARNING, and CAUTION followed by special instructions. These precautions are intended for the personal safety of you and those working with you.

Read and understand all the safety messages in this manual before you operate or service the machine.

 DANGER indicates a hazardous situation which, if not avoided, will result in death or serious injury.

 WARNING indicates a hazardous situation which, if not avoided, could result in death or serious injury.

 CAUTION, used with the safety alert symbol, indicates a hazardous situation which, if not avoided, could result in minor or moderate injury.

FAILURE TO FOLLOW DANGER, WARNING, AND CAUTION MESSAGES COULD RESULT IN DEATH OR SERIOUS INJURY.

Machine safety

NOTICE: Notice indicates a situation which, if not avoided, could result in machine or property damage.

Throughout this manual you will find the signal word Notice followed by special instructions to prevent machine or property damage. The word Notice is used to address practices not related to personal safety.

Information

NOTE: Note indicates additional information which clarifies steps, procedures, or other information in this manual.

Throughout this manual you will find the word Note followed by additional information about a step, procedure, or other information in the manual. The word Note is not intended to address personal safety or property damage.

Personal safety

Carefully read this Manual before proceeding with maintenance, repairs, refuelling or other machine operations.

Repairs have to be carried out only by authorized and instructed staff; specific precautions have to be taken when grinding, welding or when using mallets or heavy hammers.

Not authorized persons are not allowed to repair or carry out maintenance on this machine. Do not carry out any work on the equipment without prior authorization.

Ask your employer about the safety instructions in force and safety equipment.

Nobody is allowed to seat on the operator's place during machine maintenance unless he is a qualified operator helping with the maintenance work.

If it is necessary to move the equipment to carry out repairs or maintenance, do not lift or lower the equipment from any other position than the operator's seat.

Never carry out any operation on the machine when the engine is running, except when specifically indicated.

Stop the engine and ensure that all pressure is relieved from hydraulic circuits before removing caps, covers, valves, etc.

All repair and maintenance operations should be carried out with the greatest care and attention.

Service stairs and platforms used in a workshop or in the field should be built in compliance with the safety rules in force.

Any functional disorders, especially those affecting the safety of the machine, should therefore be rectified immediately.

⚠ DANGER

Unexpected movement!
Make sure parking brake is applied. Secure machine with wheel chocks.
Failure to comply will result in death or serious injury.

D0013A

Before performing any work on the machine, attach a maintenance in progress tag. This tag can be applied on the left-hand control lever, safety lever or cab door.

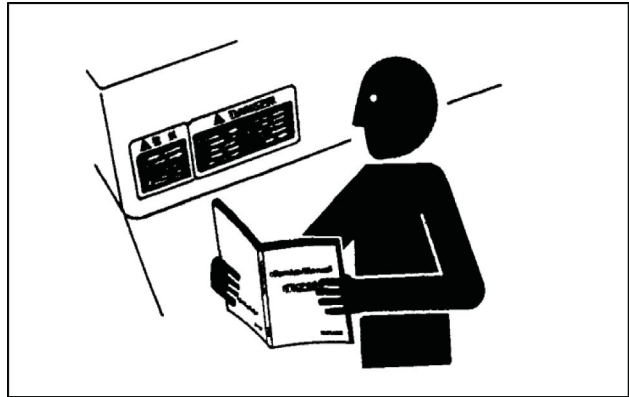

TULI12WEX2004AA 1

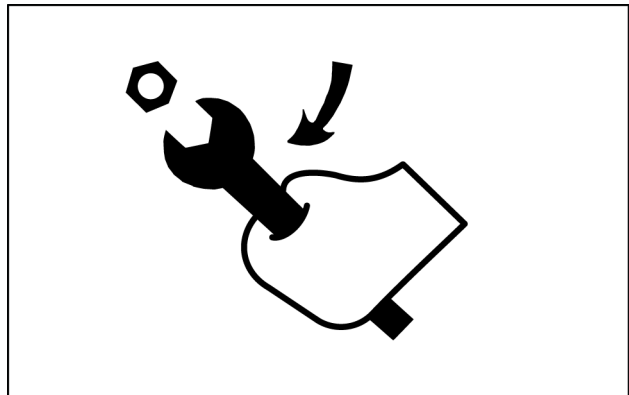

TULI12WEX2005AA 2

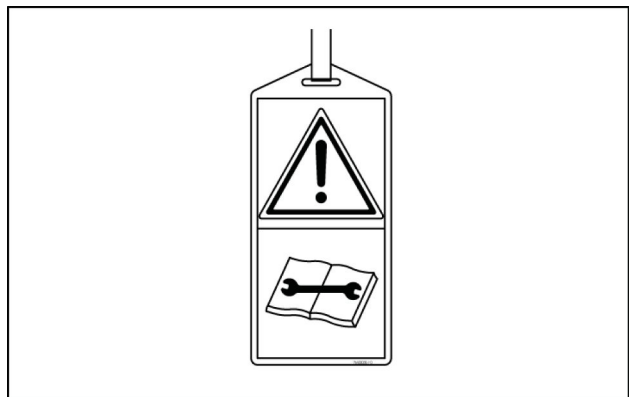

TULI12WEX2006AA 3

Emergency

Be prepared for emergencies. Always keep at disposal on the machine a first aid kit and a fire extinguisher. Make sure that the fire extinguisher is serviced in accordance with the manufacturer's instructions.

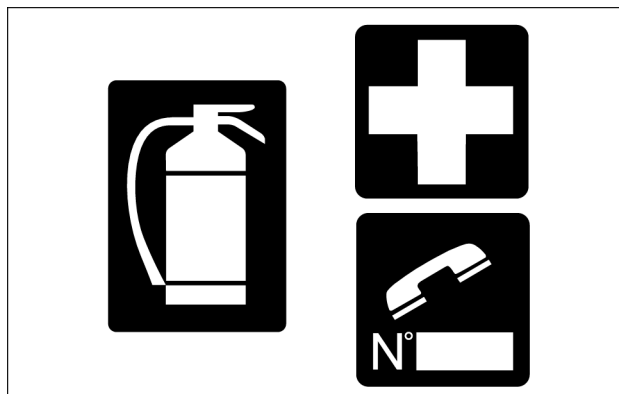

SML12WEX0174AA 4

Equipment

Wear close fitting clothing and safety equipment appropriate for the job:

- Safety helmet
- Safety shoes
- Heavy gloves
- Reflective clothing
- Wet weather clothing

If environment condition require it following personal safety equipment should be at hand:

- Respirators (or dust proof masks)
- Ear plugs or acoustic ears protections
- Goggles with lateral shield or masks for eyes protection

Do not wear rings, wristwatches, jewels, unbuttoned or flapping clothing such as ties, torn clothes, scarves, open jackets or shirts with open zips which could get caught into moving parts.

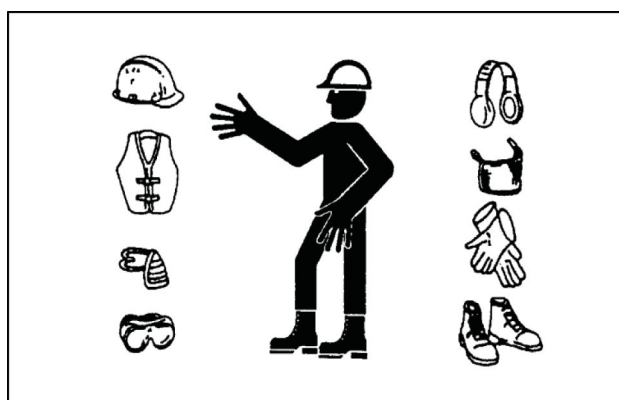

TULI12WEX2008AA 5

Engine - Radiator

Never leave the engine run in closed spaces without ventilation and not able to evacuate toxic exhaust gases. Keep the exhaust manifold and tube free from combustion materials.

Do not refuel with the engine running, especially if hot, as this increases fire hazard in case of fuel spillage.

Never attempt to check or adjust the belts when the engine is running.

Never lubricate the machine with the engine running.

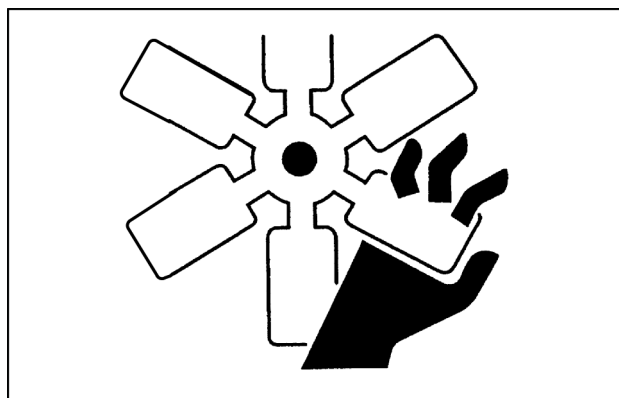

TULI12WEX2009AA 6

Pay attention to rotary pieces and do not allow to anyone to approach to avoid becoming entangled.

If hands, clothes or tools get caught in the fan blades or in the transmission belt, this can cause amputations, violent tears and generate condition of serious danger; for this reason avoid touching or to come close to all rotary or moving parts.

A violent jet of the coolant from the radiator can cause damages and scalds.

If you are to check the coolant level, you have to shut-off the engine previously and to let cool down the radiator and its pipes. Slowly unscrew the cap to release the inside pressure.

If necessary, remove the cap with hot engine, wear safety clothes and equipment, then loosen the cap slowly to relieve the pressure gradually.

When checking the fuel, oil and coolant levels, use exclusively explosion proof classified lamps. If this kind of lamps are not used fires or explosions may occur.

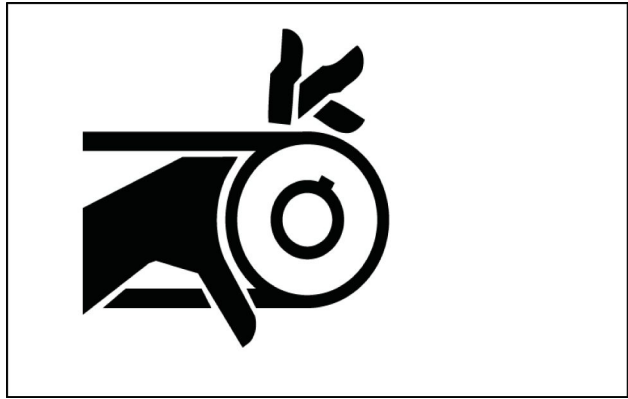

TULI12WEX2010AA 7

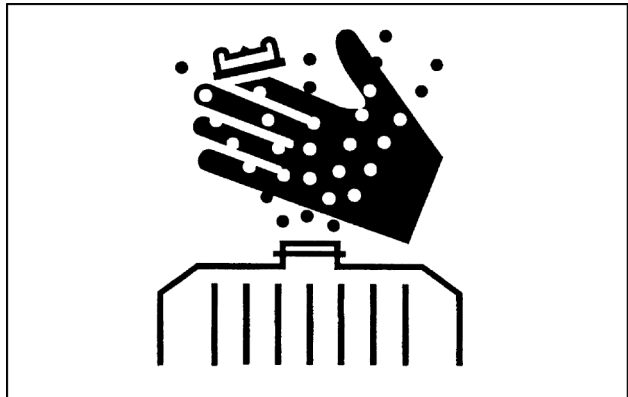

TULI12WEX2011AA 8

Hydraulic systems

Splashes of fluids under pressure can penetrate the skin causing serious injuries.

Avoid this hazard by relieving pressure before disconnecting hydraulic or other lines.

Relieve the residual pressure by moving the hydraulic control levers several times.

Tighten all connections before applying pressure.

To protect the eyes wear a facial shield or safety goggles.

Protect your hands and body from possible splashes of fluids under pressure.

Swallowing hydraulic oil is a severe health hazard.



TULI12WEX2012AA 9

INTRODUCTION

When hydraulic oil has been swallowed, avoid vomiting, but consult a doctor or go to a hospital.

If an accident occurs, see a doctor familiar with this type of injury immediately.

Any fluid penetrating the skin must be removed within few hours to avoid serious infections.

Flammable splashes may originate because of the heat near pipes with fluids under pressure, with the result of serious scalds for the persons hit. Do not weld or use torches near pipes containing fluids or other flammable materials.

Pipes under pressure can accidentally be pierced when the heat expands beyond the area immediately heated.

Arrange for fire resistant temporary shields to protect hoses or other components during welding.

Have any visible leakage repaired immediately.

Escaping oil pollutes the environment. Soak up any oil that has escaped with a proper binding agent. Sweep up binding agent and dispose of it separately from other waste.

Never search for leakages with the fingers, but use a piece of cardboard and always wear goggles.

Never repair damaged piping; always replace it. Replace hydraulic hoses immediately on detecting any damage or moist areas.

Always store hydraulic oil in the original containers.

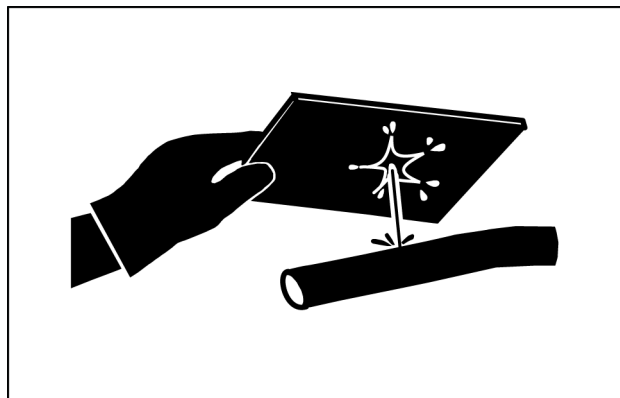

TULI12WEX2013AA 10

Hoses and tubes

Always replace hoses and tubes if the cone end or the end connections on the hose are damaged.

When installing a new hose, loosely connect each end and make sure the hose takes up the correct position before tightening the connections. Clamps should be tightened sufficiently to hold the hose without crushing and to prevent chafing.

After hose replacement to a moving component, check that the hose does not foul by moving the component through the complete range of travel. Be sure any hose which has been installed is not kinked or twisted.

Hose connections which are damaged, dented, crushed or leaking, restrict oil flow and the productivity of the components being served. Connectors which show signs of movement from the original position have failed and will ultimately separate completely.

A hose with a frayed outer sheath will allow the water penetration. Concealed corrosion of the wire reinforcement will subsequently occur along the hose length with resultant hose failure.

Ballooning of the hose indicates an internal leakage due to structural failure. This condition rapidly deteriorates and total hose failure soon occurs.

Kinked, crushed, stretched or deformed hoses generally suffer internal structural damage which can result in oil restriction, a reduction in the speed of operation and ultimate hose failure.

Free-moving, unsupported hoses must never be allowed to touch each other or related working surfaces. This causes chafing which reduces hose life.

O-rings

Replace O-rings, seal rings and gaskets whenever they are disassembled.

Never mix new and old seals or O-rings, regardless of condition. Always lubricate new seal rings and O-rings with hydraulic oil before installation to relevant seats.

This will prevent the O-rings from rolling over and twisting during mounting which will jeopardize sealing.

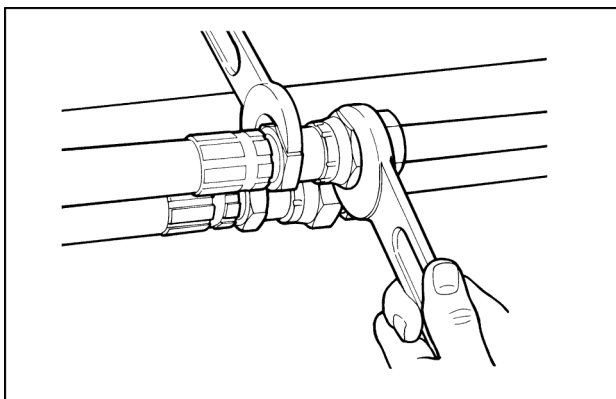

TUL112WEX2014AA 11

Battery

Batteries give off explosive gases.

Never handle naked flames and unshielded light sources near batteries, never smoke.

To prevent any risk of explosion, observe the following instructions:

- When disconnecting the battery cables, always disconnect the negative (-) cable first.
- To reconnect the battery cables, always connect the negative (-) cable last.
- Never short-circuit the battery terminals with metal objects.
- Do not weld, grind or smoke near a battery.

Battery electrolyte causes severe burns. The battery contains sulphuric acid. Avoid any contact with the skin, eyes or clothing.

Antidote:

- EXTERNAL: Rinse well with water, removing any soiled clothing.
- INTERNAL: Avoid vomiting. Drink water to rinse your mouth. Consult a doctor.
- EYES: Rinse abundantly with water for **15 min** and consult a doctor.
- When the electrolyte of a battery is frozen, it can explode if you attempt to charge the battery or if you try to start the engine using a booster battery. Always keep the battery charged to prevent the electrolyte freezing.

Provide good ventilation when changing a battery or using a battery in an enclosed space. Always protect your eyes when working near a battery.

Never set tools down on the battery. They may induce a short circuit, causing irreparable damage to the battery and injuring persons.

Never wear metal necklaces, bracelets or watch straps when working on the battery. The metal parts may induce a short circuit resulting in burns.

Dispose of used batteries separately from other waste in the interests of environmental protection.

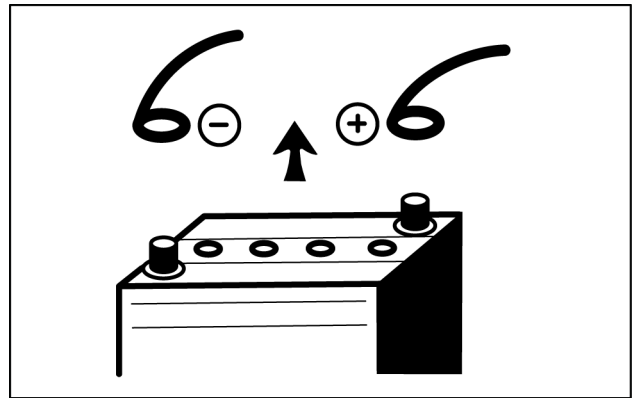

TUL112WEX2015AA 12



TUL112WEX2016AA 13

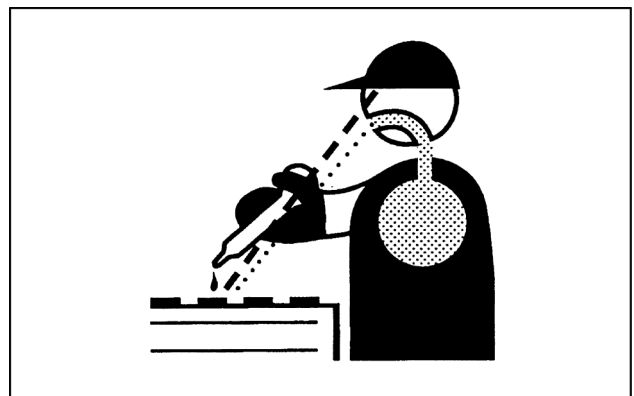

TUL112WEX2017AA 14

Flammable liquids

When handling flammable liquids:

- Do not smoke.
- Keep away from unshielded light sources and naked flames.

Fuels often have a low flash point and are readily ignited.

Never attempt to extinguish burning liquids with water. Use:

- Dry powder
- With carbon dioxide
- With foam

Water used for extinguishing purposes would vaporize instantaneously on contact with burning substances and spread burning oil, for example, over a wide area. Water generates short circuits in the electrical system, possibly producing new hazards.

Stay away from open flames during refilling of hydraulic oil or fuel.

Fuel or oil splashes can cause slipping and therefore accidents; clean immediately and accurately the areas eventually smeared.

Always tighten the safety plugs of fuel tank and hydraulic oil tank firmly.

Never use fuel to clean the machine parts eventually smeared with oil or dust.

Use a non-inflammable product for cleaning parts.

Always perform fuel or oil refilling in well aired and ventilated areas.

During refuelling hold the pistol firmly and keep it always in contact with the filler neck until the end of the refuelling, to avoid sparkles due to static electricity.

Do not overfill the tank but leave a space for fuel expansion.

Never refuel when the engine is running.

Take all the necessary safety measures when welding, grinding or when working near a naked flame.



TUL112WEX2016AA 15



TUL112WEX2018AA 16



TUL112WEX2019AA 17

Cleaning

Clean the exterior of all components before carrying out any form of repair. Dirt and dust can reduce the efficient working life of a component and lead to costly replacement.

Solvents should be checked that they are suitable for the cleaning of components and also that they do not risk the personal safety of the user.

Dirt from oil or grease and scattered tools or faulty pieces are dangerous for persons, because they can generate slipping or falls.

For the machine cleaning, use a jet of warm water or steam under pressure and commercial detergents. Never use fuel, petroleum or solvents, because the first ones leave an oily layer that favours the sticking of dust, while solvents (even if weak) damage the paint and favour the formation of rust.

Never use water jets or steam on sensors, connectors or other electric components.

Prevent that the water jet penetrates inside the cab.

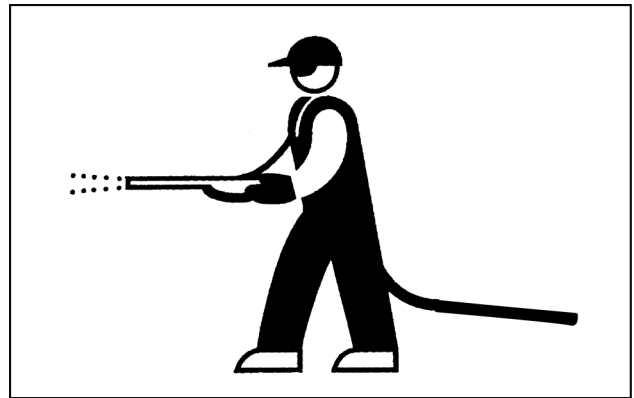

TUL112WEX2021AA 18

Waste disposal

Improperly disposing of waste can threaten the environment.

Each country has its own Regulations on this subject. It is therefore advisable to prepare suitable containers to collect and store momentarily all solid and fluid materials that must not be scattered in the environment to avoid pollution.

At preset intervals these products will be delivered to disposal stations legally recognized and present in this Country.

Hereunder are listed some products of the machine requiring disposal:

- Lubricating oil
- Brake system oil
- Coolant mixture, condensation rests and pure antifreeze
- Fuel
- Filter elements, oil and fuel filters
- Filter elements, air filters
- Battery

Also polluting rags, paper, sawdust and gloves must be disposed in compliance with the same procedures.

Do not use food or beverage containers that may mislead someone into drinking from them. Do not pour waste onto the ground, down a drain, or into any water source. Air conditioning refrigerants escaping into the air can damage the Earth's atmosphere. Government regulations may require a certified air conditioning service centre to recover and recycle used air conditioning refrigerants. Obtain information on the proper way to recycle or dispose of waste from your local environmental or recycling centre, or from your Dealer.

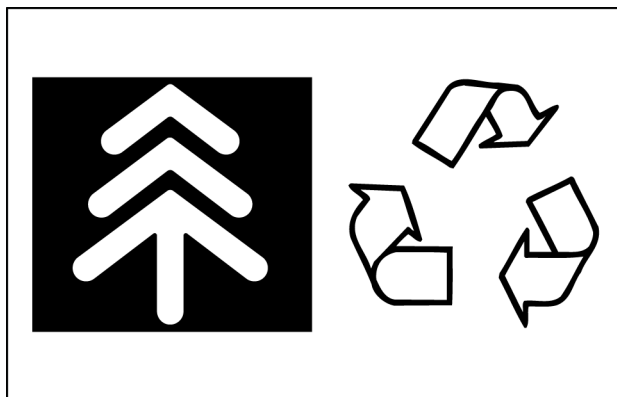

TUL112WEX2022AA 19

Torque

Bolt types

NOTICE: Use tools appropriate for the work to be done. Makeshift tools and procedures can create safety hazards. For loosening and tightening nuts and bolts, use the correct tools. Avoid bodily injury caused by slipping wrenches.



TULI12ECX0475AA 1

Tighten nuts or bolts to torque specifications. There are two kinds of bolts; hexagon T bolts (1) and socket bolts (2). The two types of bolts are made from different materials. The correct type of bolt must be used when assembling the machine and/or components.

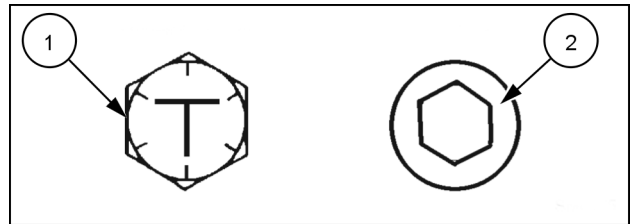

RAPH12CEX1320AA 2

Specified tightening torque chart

Bolt dia.	Wrench size	Hexagon wrench size	T bolt, socket bolt
M8	13 mm	6 mm	29.5 N·m (22 lb ft)
M10	17 mm	8 mm	64 N·m (47 lb ft)
M12	19 mm	10 mm	108 N·m (80 lb ft)
M14	22 mm	12 mm	175 N·m (129 lb ft)
M16	24 mm	14 mm	265 N·m (195 lb ft)
M18	27 mm	14 mm	390 N·m (288 lb ft)
M20	30 mm	17 mm	540 N·m (398 lb ft)
M22	32 mm	17 mm	740 N·m (546 lb ft)
M24	36 mm	19 mm	930 N·m (686 lb ft)
M27	41 mm	19 mm	1370 N·m (1010 lb ft)
M30	46 mm	22 mm	1910 N·m (1409 lb ft)
M33	50 mm	24 mm	2550 N·m (1881 lb ft)
M36	55 mm	27 mm	3140 N·m (2316 lb ft)

1. Apply lubricant (i.e. white zinc B dissolved into spindle oil) to nuts and bolts to stabilize their friction coefficients.
2. Torque tolerance is $\pm 10\%$.
3. Be sure to use bolts of correct length. Bolts that are too long cannot be tightened, as the bolt tip comes into contact with the bottom of the bolt hole. Bolts that are too short cannot develop sufficient tightening force.
4. The torques given in the chart are for general use only.
Do not use these torques if a different torque is given for a specific application.
5. Make sure that the nut and bolt threads are clean before installing. Remove dirt or corrosion, if any.

Bolt tightening order

When tightening two or more bolts, tighten them alternately, as shown, to ensure even tightening.

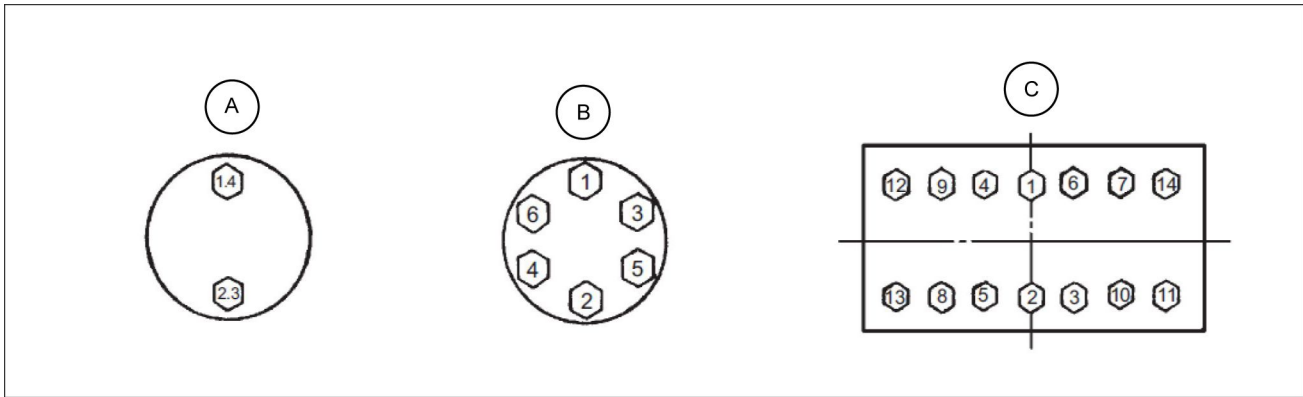

SMIL13CEX0149EA 3

- A Equally tighten upper and lower alternately
- B Tighten diagonally
- C Tighten from center and diagonally

**Thanks very much for your reading,
Want to get more information,
Please click here, Then get the complete
manual**

JustClickHere 

NOTE:

**If there is no response to click on the link above,
please download the PDF document first, and then
click on it.**

**Have any questions please write to me:
admin@servicemanualperfect.com**