

Please cut where indicated and place the label on the spine of the binder.

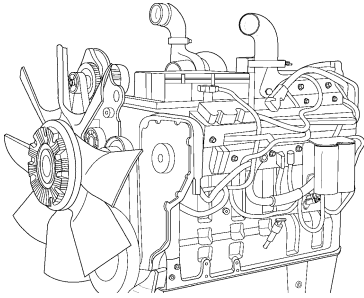

**CNH ENGINE
REPAIR MANUAL**

**8.3L, 9.0L, 6 Cyl, 24 Vlv.
High Pressure Common
Rail Fuel System**

87515682

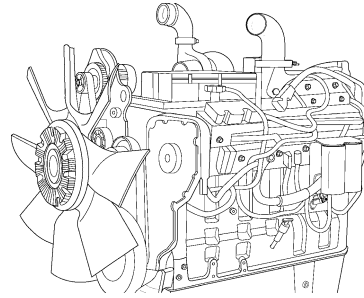

**CNH ENGINE
REPAIR MANUAL**

**8.3L, 9.0L, 6 Cyl, 24 Vlv.
High Pressure Common
Rail Fuel System**

87515682

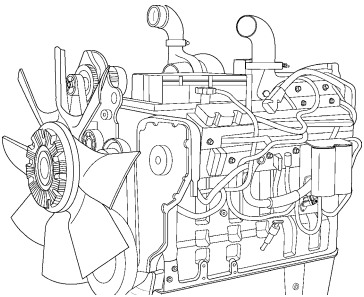

**CNH ENGINE
REPAIR MANUAL**

**8.3L, 9.0L, 6 Cyl, 24 Vlv.
High Pressure Common
Rail Fuel System**

87515682

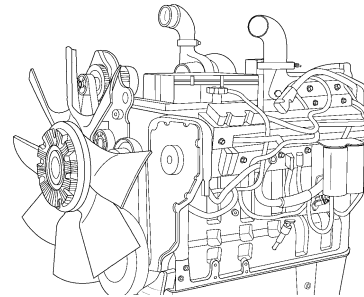

**CNH ENGINE
REPAIR MANUAL**

**8.3L, 9.0L, 6 Cyl, 24 Vlv.
High Pressure Common
Rail Fuel System**

87515682

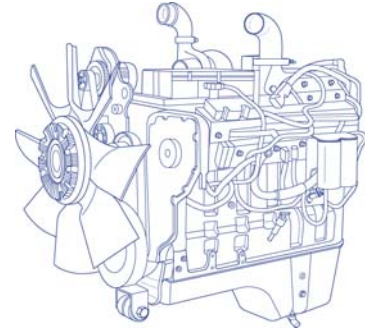

NEW HOLLAND

REPAIR MANUAL

8.3 & 9.0L 6 Cylinder, 24 Valve CNH Engine with High Pressure Common Rail Fuel System



Repair Manual Number 87515682

POWER PRODUCTION - B

87515684

Introduction

Engine - B.10.A

87515685

Fuel and Injection System - B.20.A

87515686

Air Intake System - B.30.A

Exhaust System - B.40.A

Engine Coolant System - B.50.A

Lubrication System - B.60.A

Starting System - B.80.A

You can order Repair Manual Books separately (see publication numbers above) or you can order a complete Engine Repair Manual (Publication Number 87515682).



NEW HOLLAND

REPAIR MANUAL

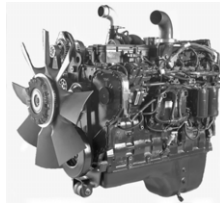

TG215 , TG245 , TG275 , TG305 , TJ280 , TJ330

Contents

INTRODUCTION

POWER PRODUCTION

B

ENGINE

B.10.A

FUEL AND INJECTION SYSTEM

B.20.A

AIR INTAKE SYSTEM

B.30.A

EXHAUST SYSTEM

B.40.A

ENGINE COOLANT SYSTEM

B.50.A

LUBRICATION SYSTEM

B.60.A

STARTING SYSTEM

B.80.A



NEW HOLLAND

INTRODUCTION

Contents

INTRODUCTION

Foreword – How to use this manual (- A.10.A.40)	3
Safety rules (- A.50.A.10)	10
Basic instructions (- A.90.A.05)	11
Torque (- A.90.A.10)	14
Definition (- A.92.A.15)	17
Conversion factors (- A.92.A.21)	20
Product identification (- A.80.A.10)	21

Foreword – How to use this manual (- A.10.A.40)

The information in this manual is organized using the Integrated Coding Environment (ICE). ICE is a shorthand system for pointing to Sections, Chapters and sub-Chapters in the manual without using the words. ICE also identifies the type of information at that location.

A search for information on an engine component will likely begin at the Table of Contents (TOC) or the Index: for example, a search for information on the rear seal of the crankshaft. When you locate “crankshaft - rear seal” in the TOC with the indicated page number, this Foreword explains:

- how to proceed to the correct location in the manual based on the ICE code,
- how to identify the type of information you may expect at that location.

Crankshaft	
Crankshaft - Remove (B.10.A.43 - F.10.A.10)	139
Crankshaft - Install (B.10.A.43 - F.10.A.15)	140
Crankshaft - End play (B.10.A.43 - F.40.E.10)	141
Crankshaft - Front seal - Remove (B.10.A.43.01 - F.10.A.10)	142
Crankshaft - Front seal - Visual inspection (B.10.A.43.01 - F.40.A.10)	144
Crankshaft - Front seal - Install (B.10.A.43.01 - F.10.A.15)	145
Crankshaft - Rear seal - Remove (B.10.A.43.02 - F.10.A.10)	148
Crankshaft - Rear seal - Visual inspection (B.10.A.43.02 - F.40.A.10)	149
Crankshaft - Rear seal - Install (B.10.A.43.02 - F.10.A.15)	150

RCPH05CDC414ABA 1

NOTE: Due to differences in languages and models, the page number indicated in the illustration may not applicable to your manual. Refer to the table of contents in your repair manual.

Location

The first half of an ICE code describes the location of the information.

(The ICE code has two parts separated by a hyphen. The first part describes the location. The periods break up the ICE code into its parts.)

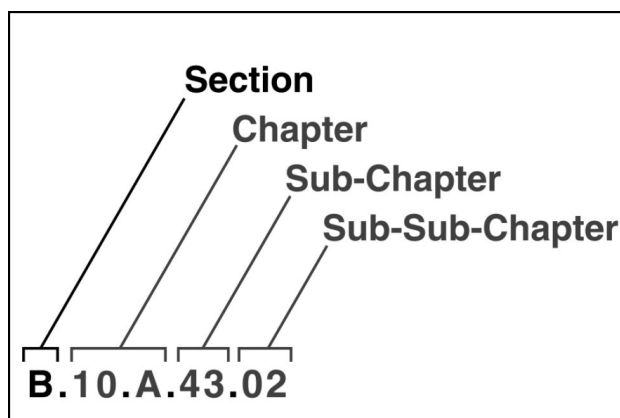

RCPH05CDC476ABA 2

The first letter identifies the section.

Sections are arranged alphabetically in a manual. This engine repair manual is contained within one section – the Power Production Section – signified by the letter “B,” and all ICE references in the manual begin with the letter “B.”

Do NOT confuse a section with a bound book. Because of its size, a section may require more than one bound book, sometimes a book for each chapter within a section.

This repair manual, although contained within one section, requires more than one bound book. The book cover always lists both the section(s) and chapter(s) contained inside the bound book.

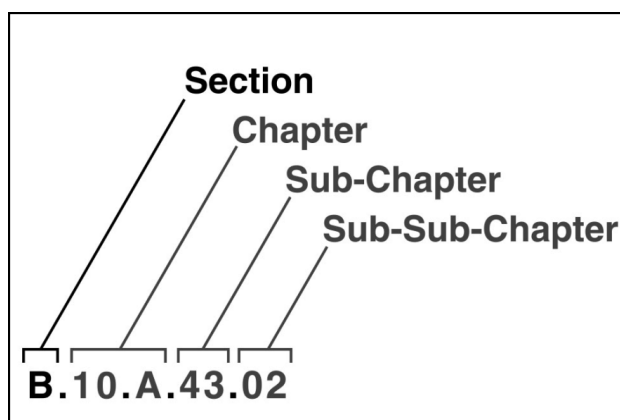

RCPH05CDC476ABA 3

The second number and letter identify the chapter within the section.

Chapters are arranged numerically within the section.

The chapters used in this manual are listed below:

- ENGINE (B.10.A)
- FUEL AND INJECTION SYSTEM (B.20.A)
- AIR INTAKE SYSTEM (B.30.A)
- EXHAUST SYSTEM (B.40.A)
- ENGINE COOLANT SYSTEM (B.50.A)
- LUBRICATION SYSTEM (B.60.A)
- STARTING SYSTEM (B.70.A)

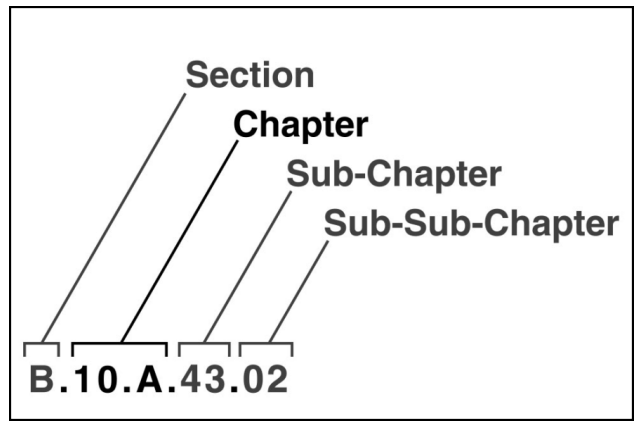

RCPH05CDC483ABA 4

The coding indicates that the rear seal is located in Chapter 10.A (Engine), of Section B (Power Production).

The section and chapter titles (**A**) are displayed at the top of each page in the body of the manual.

The ICE code for the section, chapter and page number (for example, B.10.A/149) (**B**) are displayed at the bottom of each page in the body of the manual.

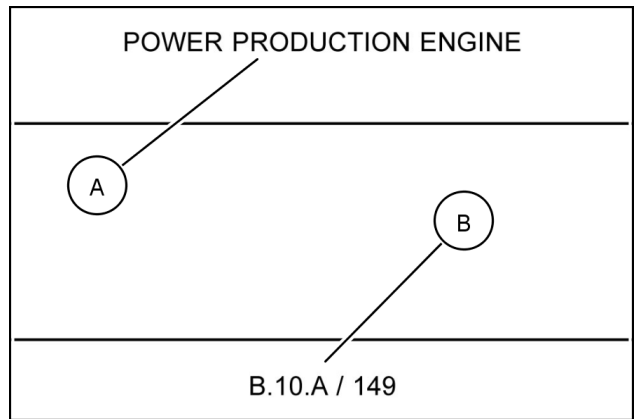

RCPH05CDC407ABA 5

The last two positions in the location code always form the title of the document – in this example, crankshaft - rear seal.

The third number identifies a sub-chapter within the chapter.

The number “43” represents the crankshaft and indicates that rear seal information is located under crankshaft in Chapter 10.A of Section B.

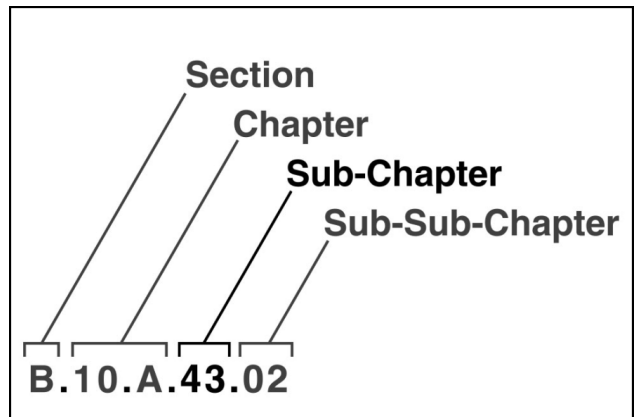

RCPH05CDC490ABA 6

The fourth number identifies the rear seal itself, a sub-topic (or sub-sub-chapter) of crankshaft. This is not any rear seal; this is the rear seal for the crankshaft.

The page numbers for rear seal information within Chapter 10.A are also given.

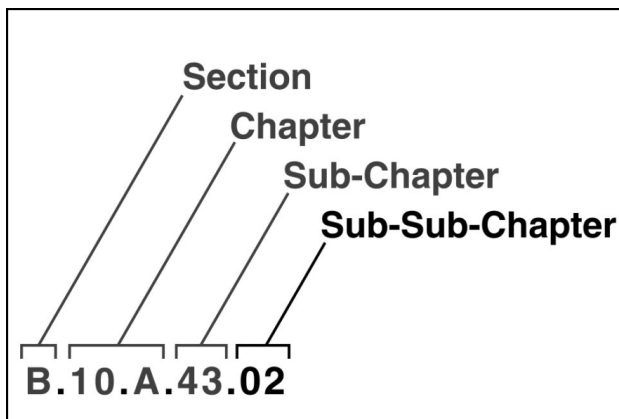

RCPH05CDC497ABA 7

If the same location is viewed as part of a manual outline, the uniqueness of the location is apparent. Rear seal information is the only information that will be found at B.10.A.43.02 within the entire manual.

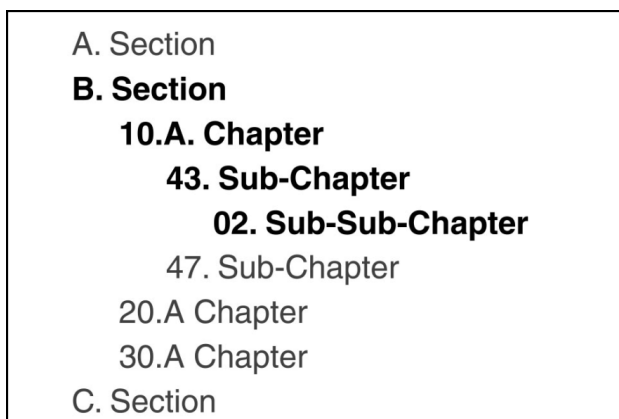

RCPH05CDC506ABA 8

When you locate the information at the given page number, the page heading confirms the location.

POWER PRODUCTION ENGINE

Crankshaft Rear seal - Remove (B.10.A.43.02 - F.10.A.10)

Prior operation: Refer to the chassis service manual to remove the components required to access the crankshaft rear seal.
 Prior operation: Flywheel - Remove (B.10.A.50 - F.10.A.10)

- This procedure is used for standard rear seals (A) when no wear sleeve (B) is present. See Crankshaft Rear wear sleeve - Remove (B.10.A.43.06 - F.10.A.10) if a wear sleeve is installed.

RCPH05CDC393ABA 9

Information type (Infotype)

The information in each chapter, and therefore the table of contents, is separated into four broad categories:

- Technical Data
- Functional Data
- Service Data
- Diagnostic Data

NOTE: The information in the Index for a chapter is organized alphabetically. The locations are listed alphabetically, and then information from the different categories is listed alphabetically for the location.

This is the order of the information in the chapter and the table of contents. These are the exact headings used in the table of contents to separate the information.

There may be information on any component, like the rear seal of the crankshaft, in any of the four categories.

The location is the same – B.A.10.43.02 for all four categories. The second part of the code which identifies the type of information, or infotype, is different.

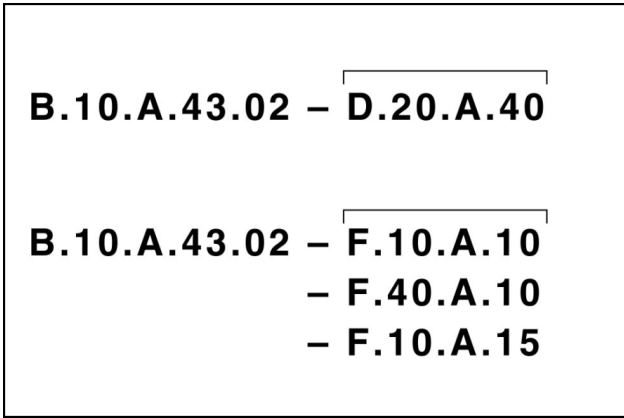

RCPH05CDC421ABA 10

In fact, there are only two types of information offered on the crankshaft rear seal in this manual:

- technical data which describes a special tool needed for installation (**A**),
- and service data, which describes seal removal, inspection and installation (**B**).

The first grouping in the illustration is located under the Technical Data heading in the TOC. The second grouping is located under the Service Data heading in the TOC.

Crankshaft	
Crankshaft - Service limits (B.10.A.43 - D.20.A.20)	29
Crankshaft - Special tools (B.10.A.43 - D.20.A.40)	29
Crankshaft - Front seal - Torque (B.10.A.43.01 - D.20.A.10)	30
Crankshaft - Front seal - Special tools (B.10.A.43.01 - D.20.A.40)	30
Crankshaft - Rear seal - Special tools (B.10.A.43.02 - D.20.A.40)	31
Crankshaft	
Crankshaft - Remove (B.10.A.43 - F.10.A.10)	139
Crankshaft - Install (B.10.A.43 - F.10.A.15)	140
Crankshaft - End play (B.10.A.43 - F.40.E.10)	141
Crankshaft - Front seal - Remove (B.10.A.43.01 - F.10.A.10)	142
Crankshaft - Front seal - Visual inspection (B.10.A.43.01 - F.40.A.10)	144
Crankshaft - Front seal - Install (B.10.A.43.01 - F.10.A.15)	145
Crankshaft - Rear seal - Remove (B.10.A.43.02 - F.10.A.10)	148
Crankshaft - Rear seal - Visual inspection (B.10.A.43.02 - F.40.A.10)	149
Crankshaft - Rear seal - Install (B.10.A.43.02 - F.10.A.15)	150

RCPH05CDC406ABA 11

The coding for technical information always begins with the letter “D.” The coding for the service information always begins with the letter “F.”

The first letter of the infotype code always explains the category of the information:

- D = technical data,
- C = functional data,
- F = service data,
- G = diagnostic data.

Crankshaft	
Crankshaft - Service limits (B.10.A.43 - D.20.A.20)	29
Crankshaft - Special tools (B.10.A.43 - D.20.A.40)	29
Crankshaft - Front seal - Torque (B.10.A.43.01 - D.20.A.10)	30
Crankshaft - Front seal - Special tools (B.10.A.43.01 - D.20.A.40)	30
Crankshaft - Rear seal - Special tools (B.10.A.43.02 - D.20.A.40)	31
Crankshaft	
Crankshaft - Remove (B.10.A.43 - F.10.A.10)	139
Crankshaft - Install (B.10.A.43 - F.10.A.15)	140
Crankshaft - End play (B.10.A.43 - F.40.E.10)	141
Crankshaft - Front seal - Remove (B.10.A.43.01 - F.10.A.10)	142
Crankshaft - Front seal - Visual inspection (B.10.A.43.01 - F.40.A.10)	144
Crankshaft - Front seal - Install (B.10.A.43.01 - F.10.A.15)	145
Crankshaft - Rear seal - Remove (B.10.A.43.02 - F.10.A.10)	148
Crankshaft - Rear seal - Visual inspection (B.10.A.43.02 - F.40.A.10)	149
Crankshaft - Rear seal - Install (B.10.A.43.02 - F.10.A.15)	150

RCPH05CDC406ABA 12

Technical data may be:

- a specification for the engine, the fuel system, the air intake system, etc.,
- a special tool, whether recommended or required, to perform a service procedure on the component,
- a torque value for installing a component,
- a service limit criterion, for determining when a component must be replaced or the pass/fail criterion for a test.

POWER PRODUCTION ENGINE

Crankshaft Rear seal - Special tools (B.10.A.43.02 - D.20.A.40)

Crankshaft rear seal installer – CNH299155
 This tool is used to install the rear crankshaft seal on CDC engines with or without a wear sleeve. When a dust seal is present, tool 380002456 is also needed.



RCPH05CDC08AAA 1

RCPH05CDC422ABA 13

Functional data may be:

- a dynamic description of how a system or sub-system works during operation,
- a static description of a system component,
- an identification illustration to show the location of components – sensor locations, fuel system components, lubrication system components, etc.

AIR INTAKE SYSTEM - Dynamic description (B.30.A - C.30.A.10)

The combustion air system consists of an air pre-cleaner and cleaner, intake air piping, turbocharger, charge air piping, air cooler and air heater.

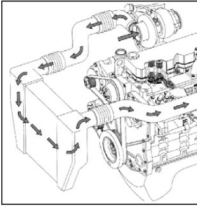

RCPH05CDC078AAB 1

Air drawn through the air pre-cleaner and cleaner and into the compression side of the turbocharger. It is forced through piping from the discharge to the air cooler, the intake air heater and into the intake manifold. From the manifold, air is forced into the cylinders and used for combustion.

RCPH05CDC429ABA 14

Service data may be:

- a basic service action like remove, disassemble, assemble or install,
- an inspection or testing procedure,
- an adjusting or measuring procedure.

ENGINE COOLANT SYSTEM - Test (B.50.A - F.40.C.01)

NOTE: Combustion produces carbon dioxide. Carbon dioxide dissolved in engine coolant for combustion gas leak tester – 3822985 (CUMMINS) – checks for the presence of carbon acid in

Combustion gas leak test

1. Remove the pressure cap, and check if the coolant level in the deaeration tank is low enough to prevent contamination of the test tool – 3822985 (CUMMINS). The instrument tests the air at the top of the deaeration tank, not the coolant. If required, drain sufficient coolant so the level is 50 - 100 mm (2.0 - 3.0 in) below the neck of the tank.

WARNING

DO NOT remove coolant system pressure cap while coolant is HOT. Wait until the coolant temperature is below 50 degrees C (120 degrees F) before removing the system pressure cap. Failure to do so will cause injury. M941



RCPH05CDC436ABA 15

Diagnostic data may be:

- guided troubleshooting to correct a problem,
- symptom-based troubleshooting to locate the source of a problem.

LUBRICATION SYSTEM - Problem solving (B.60.A - G.40.A.30)	
OPERATION	
Refer to LUBRICATION SYSTEM - Dynamic description (B.60.A - C.30.A.10) .	
TROUBLESHOOTING	
•	A thorough analysis of a customer's complaint is the key to successful troubleshooting. The more known about a complaint, the faster and easier the problem can be resolved.
•	The tables are organized to locate a problem by doing the easiest and most logical thing first, all steps in the sequence from top to the bottom.
•	It is NOT possible to list all possible solutions to all possible problems; however, these tables stimulate a thought process that will lead to the cause and correction of the problem.
•	Follow these basic troubleshooting steps: <ul style="list-style-type: none"> • Get all the facts concerning the complaint. • Analyze the problem thoroughly. • Relate the symptoms to the basic engine systems and components. • Consider any recent maintenance or repair work that might relate to the complaint. • Double check before beginning any disassembly.

RCPH05CDC443ABA 16

When searching for information in the table of contents or the index, pay attention to the first letter of the infotype and its title (special tool, dynamic description, remove, problem-solving) so you find the type of information you are seeking.

Applicability – Does the information apply to my model?

If an entry in the table of contents or the index has no models listed immediately beneath it, the information applies to all models listed on the repair manual, section or chapter cover.

The information shown is applicable to all models.

Crankshaft		
Crankshaft - Remove (B.10.A.43 - F.10.A.10)		139
Crankshaft - Install (B.10.A.43 - F.10.A.15)		140
Crankshaft - End play (B.10.A.43 - F.40.E.10)		141
Crankshaft - Front seal - Remove (B.10.A.43.01 - F.10.A.10)		142
Crankshaft - Front seal - Visual inspection (B.10.A.43.01 - F.40.A.10)		144
Crankshaft - Front seal - Install (B.10.A.43.01 - F.10.A.15)		145
Crankshaft - Rear seal - Remove (B.10.A.43.02 - F.10.A.10)		148
Crankshaft - Rear seal - Visual inspection (B.10.A.43.02 - F.40.A.10)		149
Crankshaft - Rear seal - Install (B.10.A.43.02 - F.10.A.15)		150

RCPH05CDC414ABA 17

When an entry in the TOC or index has models listed below it, the information applies only to those models.

Although the location code, infotype code and title of the entry are exactly the same, the model names inform you that the content varies by model.

Go to the page number listed for your model. When you locate the information in the manual, the same models are listed below the title to confirm that you are at the right location.

Connecting rod and piston - Disassemble (B.10.A.47 - F.10.A.25)	TG215, TG245, TG275, TJ280
Connecting rod and piston - Disassemble (B.10.A.47 - F.10.A.25)	TG305, TJ330

RCPH05CDC503ABA 18

Prior Operation and Next Operation

This manual makes extensive use of “Prior operation” and “Next operation” lists to avoid repetition.

A “Prior operation” list always occurs at the beginning of document and points to procedures which must precede the current procedure.

A “Next operation” list always occurs at the end of a document and points to procedures which must follow the current procedure in order to restore the engine to active service.

Prior and Next operations usually contain an ICE code reference which follows the same format as previously explained. For example, installation of the lower main bearings and bearing caps is the first operation listed after the crankshaft is installed. The ICE code given is (B.10.A.43.15 - F.10.A.15) with the title, Crankshaft Main Bearing - Install.

The location code points to the sub-topic main bearings (4), in the sub-chapter on the crankshaft (3), in Chapter 10.A (2), of Section B (1).

The infotype code points to a service procedure because of the initial letter “F” that is located under Service Data in the table of contents.

Crankshaft - Install (B.10.A.43 - F.10.A.15)

Prior operation: Crankshaft Journal - Measure (B.10.A.43.16 - F.40.E.01)
 Prior operation: Crankshaft Gear - Install (B.10.A.43.10 - F.10.A.15)
 Prior operation: Crankshaft Speed ring - Install (B.10.A.43.20 - F.10.A.15)

Next operation: Install the lower main bearings and bearing caps. See C (B.10.A.43.15 - F.10.A.15)
 Next operation: Crankshaft - End play (B.10.A.43 - F.40.E.10)
 Next operation: Install the lower rod bearings and rod caps. See Connect - F.10.A.15)
 Next operation: Rear cover - Install (B.10.A.76 - F.10.A.15)
 Next operation: Timing gear housing - Install (B.10.A.46 - F.10.A.15)
 Next operation: Valve drive Camshaft - Install (B.10.A.40.44 - F.10.A.15)
 Next operation: Valve drive Camshaft - End play (B.10.A.40.44 - F.40.E.10)
 Next operation: Valve drive Camshaft - Backlash (B.10.A.40.44 - F.40.E.15)
 Next operation: Oil pan - Install (B.60.A.23 - F.10.A.15)
 Next operation: LUBRICATION SYSTEM - Filling (B.60.A - F.60.A.10)
 Next operation: ENGINE COOLANT SYSTEM - Filling (B.50.A - F.60.A.10)

RCPH05CDC466ABA 19

(B.10.A.43.15 - F.10.A.15)

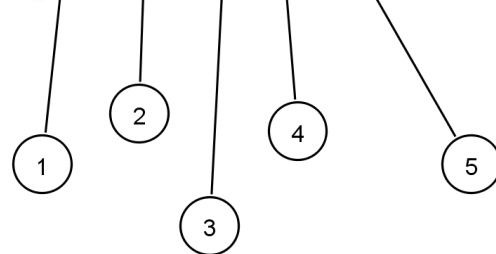

RCPH05CDC473ABA 20

Safety rules (- A.50.A.10)

Read and understand all of the safety precautions and warnings before performing any repair. This list contains the general safety precautions that must be followed for your personal safety. Additional safety precautions are included in the procedures where they apply.

General safety precautions

- The work area around the engine must be dry, well lit, ventilated, free from clutter, ignition sources and hazardous substances.
- Always wear protective glasses and protective shoes when working.
- Stay clear of rotating parts which can cut, mutilate or strangle.
- Do NOT wear loose-fitting or torn clothing. Remove all jewelry when working.
- Disconnect the battery [negative (-) cable first] and discharge any capacitors before beginning any repair work. Put a "Do NOT Operate" tag in the cab or on the controls.
- Only use proper engine barring techniques when rotating the engine manually. Do NOT attempt to rotate the crankshaft by pulling or prying on the fan. This practice may cause serious personal injury, property damage, fan damage or premature fan failure.
- When coolant is hot from engine operation, allow the engine to cool before slowly loosening the pressure cap to relieve pressure in the cooling system.
- ALWAYS use blocks or the proper engine stand to support the engine before performing any repair work. Do NOT work on an engine which is only supported by floor jacks or a hoist.
- Relieve all pressure in the air, oil and cooling systems before any lines, fittings or related items are removed or disconnected. Be alert for possible pressure when disconnecting any component from a system that uses pressure. Do NOT check for leaks with your hand. High pressure oil or fuel can cause personal injury.
- To reduce the possibility of personal injury, use a hoist or an assistant when lifting components that weigh **23 kg (50 lb)** or more. Make sure all lifting equipment – such as chains, hooks or slings – is in good condition and of the correct capacity. Make sure all lift hooks are positioned correctly. ALWAYS use a spreader bar when necessary; lifting hooks must NOT be side-loaded.
- Corrosion inhibitor, a component of coolant additives and lubricating oil, contains alkali. Do NOT get the substance in eyes. Avoid prolonged or repeated contact with skin. Do NOT swallow internally. In case of contact, immediately wash skin with soap and water. In case of contact, immediately flood eyes with large amounts of water for a minimum of 15 minutes. IMMEDIATELY CALL A PHYSICIAN. KEEP OUT OF THE REACH OF CHILDREN.
- Naptha and Methy Ethyl Ketone (MEK) are flammable materials and MUST be used with caution. Follow the manufacturer's instructions when using these materials. KEEP OUT OF THE REACH OF CHILDREN.
- To prevent burns, be aware of heated parts and hot fuel in lines, tubes and compartments on recently operated engines.
- ALWAYS use tools that are in good condition. Understand the correct use of the tool before performing repair work. Use ONLY genuine CNH replacement parts.
- ALWAYS use the same fastener part number (or equivalent) when replacing fasteners. Do NOT use a fastener of lesser quality when replacing components.
- Do not perform any repair when fatigued or after consuming alcohol or drugs that can impair your functioning.
- Some government agencies have determined that used engine oil can be carcinogenic and can cause reproductive toxicity. Avoid inhalation of vapors, ingestion and prolonged contact with used engine oil.
- Coolant is toxic. If NOT reused, follow local environmental regulations for proper disposal.

Basic instructions (- A.90.A.05)

Definition of “clean”

Parts must be free of debris that can contaminate any engine system. This does not mean that cleaned parts have to appear to be new.

Abrasive pads and abrasive paper

There is no part of an engine designed to withstand abrasion. All engine components are designed to lock together or slide across each other. Abrasives and dirt particles will degrade both functions.

CNH does NOT recommend the use of emery cloth or sand paper on any part of an ASSEMBLED engine or component, especially for removing the carbon ridge from cylinder liners or to clean block decks or counterbores.

Use abrasive products with great care when cleaning engine parts, particularly on partially assembled engines.

These cleaning products come in many forms and sizes. All contain aluminum oxide particles, silicon carbide, sand or some other similar hard material. These materials are harder than most parts of the engine. When pressed against a softer material, they will either damage the material or become embedded in it.

Once embedded in a part, the abrasive particle will abrade the other part it contacts until contact is no longer made between the two parts. If the damage sufficiently degrades the oil film, the two parts may fail prematurely from ineffective lubrication.

In addition, particles fall off of the holding material as the abrasive product is being used.

Gasket surface

The object in cleaning gasket surfaces is to remove gasket material, not to refinish the gasket surface on the part.

CNH does NOT recommend any specific brand of liquid gasket remover. If a liquid gasket remover is used, check the manufacturer's directions to make sure the part being cleaned will not be damaged.

Air powered gasket scrapers can save time, but the surface cannot be damaged in the process.

All old gasket material must be removed from the gasket mating surfaces. However, it is not necessary to clean and polish the gasket surface until the machining marks are erased. Excessive sanding or buffing can damage the gasket sealing surface. Surface finish and flatness tolerances must be maintained to form a quality sealing surface.

Solvents and acid cleaning

Solvents and acid-type cleaner can be used to clean disassembled engine parts (with the exception of pistons). The best results are obtained with a cleaner that can be heated to **90 - 95 °C (180 - 200 °F)**. CNH does NOT recommend any specific brand of cleaner. Always follow the manufacturer's instructions when using cleaning solutions.



WARNING



When using solvents, acids or alkaline materials for cleaning, follow the manufacturer's recommendations for use. Wear goggles and protective clothing to reduce the possibility of personal injury. M995

Kerosene emulsion based cleaners work the best for cleaning pistons. These cleaners should NOT be heated to temperatures in excess of **82 °C (180 °F)**. The cleaners begin to break down at temperatures in excess of **82 °C (180 °F)** and will be less effective.

Do NOT use solutions composed primarily of chlorinated hydrocarbons with cresols, phenols and/or cresylic components. These solutions often do NOT clean well and are costly to dispose of properly.

Solutions with a pH above 7.0 are considered alkaline and those below 7.0 are acidic. The solutions become highly alkaline or highly acidic the further they move from the neutral 7.0. Solutions with a pH above approximately 9.5 cause aluminum to turn black; highly alkaline solutions must NOT be used.

A cleaning tank that provides a constant mixing and filtering of the cleaning solution will yield the best results.

- Remove all gasket material, O-rings and sludge or carbon deposits with a wire brush or scraper before putting the parts in the cleaning tank.
- When possible, use high pressure water or steam clean the parts before submerging them in the tank. Removing the heaviest dirt before tank cleaning will allow the cleaner to work more effectively.
- Rinse all parts in hot water after cleaning. Dry completely with clean shop air. Use air to remove the rinse water from all cap screw holes and the oil drillings.
- If the parts are NOT to be used immediately after cleaning, dip them in a suitable rust proofing compound. This compound MUST be removed from the parts before assembly or installation on the engine.

Steam cleaning

Steam cleaning can be used to remove all types of dirt that may contaminate the cleaning tank. Steam cleaning is an excellent method for cleaning oil drillings and coolant passages.



WARNING



Always wear protective clothing, safety glasses or a face shield when using a steam cleaner or power washer. Failure to wear protective equipment can cause serious injury. M927

The following components should NEVER be steam cleaned:

- | | |
|-------------------------|-----------------------------------|
| – electrical components | – belts and hoses |
| – wiring harnesses | – bearings (ball or taper roller) |
| – injectors | – electronic control module (ECM) |
| – fuel pump | – ECM connectors |

Plastic bead cleaning

CNH recommends using ONLY plastic bead media on any engine part.

CNH does NOT recommend the use of glass bead blast or walnut shell media on ANY engine part. NEVER use sand as a blast media on any engine part. Glass and walnut shell media can cause excess dust and can embed in engine parts, which can result in premature component failure from abrasive wear.

Plastic beading can be used on many engine components to remove carbon deposits. The cleaning process is controlled by the use of plastic beads, the operating pressure and the cleaning time.



CAUTION



Do not use the bead blasting cleaning method on aluminum piston skirts or bore pins in any piston, piston skirt or piston crown. Small particles of the media will embed in the aluminum or other soft metal and result in premature wear of the cylinder liner, piston rings, pins and pin bores. Valves, turbocharger shafts, etc. can also be damaged. Follow the cleaning methods specified in the procedure. M1064



CAUTION



Do not contaminate wash tanks and tank type solvent cleaners with foreign material and plastic beads. Remove the foreign material and plastic beads with compressed air, hot high pressure water or steam before placing them in tanks and cleaners. The foreign material and plastic beads can contaminate the tank and any other engine parts cleaned in the tank. Contaminated parts may cause failures from abrasive wear. M1065

Plastic bead material (U.S. size 16-20) can be used to clean piston ring grooves. Do NOT use bead blasting media on piston pin bores or aluminum skirts. Bead blasting is best used on stubborn dirt or carbon build-up that has NOT been removed by steam or high pressure washing, followed by cleaning in a heated wash tank. This is particularly true of pistons: steam and soak the pistons first and then use the plastic bead method to safely remove the carbon remaining in the grooves.

Follow the equipment manufacturer's cleaning instructions. Adjust the air pressure in the blasting machine to the manufacturer's recommendation. Use these guidelines when plastic bead blasting recommendations are not available:

-
- Use plastic bead size 16-20 (U.S. size) or equivalent.
 - Use an operating pressure of **270 kPa (40 psi)** for piston cleaning. Pressure should not cause the beads to break.
 - Steam clean or wash the parts with solvent to remove all foreign material and plastic beads after cleaning. Rinse with hot water. Dry with compressed air.
-



CAUTION



Bead blasting must not disturb the metal surface of the component. If the metal surface is disturbed, the engine can be damaged due to increased parts clearance or inadequate surface finish on parts that move against other parts. M1066



- When cleaning pistons, it is NOT necessary to remove all the dark stain from the piston. Removing the carbon on the rim and from the ring grooves IS necessary. Direct the blast across the part rather than straight at the part. If machining marks are disturbed by the blasting process, the pressure is too high or the blast is being held on one spot too long. The blast operation must not disturb the metal surface.
- Always direct the bead blast nozzle across rather than at the part. This allows the beading to get under the unwanted material. Keep the nozzle moving, rather than held in one spot, to prevent surface damage.
- Never bead blast valve stems. Tape or use a sleeve to protect the stems during bead blasting. Direct the nozzle across the seat surface and radius rather than straight at them.

Torque (- A.90.A.10)

IMPORTANT: When replacing cap screws, always use a cap screw of the same measurement and strength as the cap screw being replaced.

Metric cap screws and nuts are identified by the grade number stamped on the head of the cap screw or on the surface of the nuts. U.S. customary cap screws are identified by radial lines stamped on the head of the cap screw.

Cap screw marking and torque value – Metric

Commercial steel class												
8.8				10.9				12.9				
Cap screw head marking												
 rh04h178 1				 rh04h179 2				 rh04h180 3				
Dia. mm	Cast iron		Aluminum		Cast iron		Aluminum		Cast iron		Aluminum	
	Nm	ft lb	Nm	ft lb	Nm	ft lb	Nm	ft lb	Nm	ft lb	Nm	ft lb
6	9	5	7	4	13	10	7	4	14	9	7	4
7	14	9	11	7	18	14	11	7	23	18	11	7
8	23	17	18	14	33	25	18	14	40	29	18	14
10	45	33	30	25	65	50	30	25	70	50	30	25
12	80	60	55	40	115	85	55	40	125	95	55	40
14	125	90	90	65	180	133	90	65	195	145	90	65
16	195	140	140	100	280	200	140	100	290	210	140	100
18	280	200	180	135	390	285	180	135	400	290	180	135
20	400	290	–	–	550	400	–	–	–	–	–	–

NOTES

1. Always use the torque values listed in the above table when specific torque values are not supplied in a procedure.
2. Do NOT use these torque values in place of specified torque values in a procedure.
3. The values in the table are based on lubricated threads.

Cap screw marking and torque value – U.S. Customary

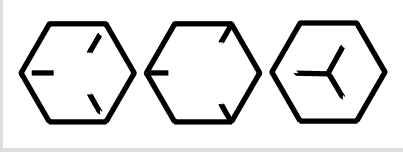
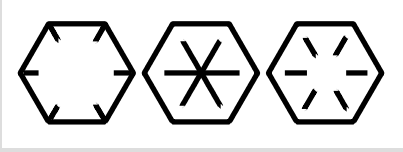
Body size	Cap screw head marking							
	SAE Grade 5				SAE Grade 8			
	 rh04h175 4				 rh04h176 5			
Cast iron		Aluminum		Cast iron		Aluminum		
	Nm	ft lb	Nm	ft lb	Nm	ft lb	Nm	ft lb
1/4 - 20	9	7	8	6	15	11	8	6
1/4 - 28	12	9	9	7	18	13	9	7
5/16 - 18	20	15	16	12	30	22	16	12
5/16 - 24	23	17	19	14	33	24	19	14
3/8 - 16	40	30	25	20	55	40	25	20
3/8 - 24	40	30	35	25	60	45	35	25
7/16 - 14	60	45	45	35	90	65	45	35
7/16 - 20	65	50	55	40	95	70	55	40
1/2 - 13	95	70	75	55	130	95	75	55
1/2 - 20	100	75	80	60	150	110	80	60
9/16 - 12	135	100	110	80	190	140	110	80
9/16 - 18	150	110	115	85	210	155	115	85
5/8 - 11	180	135	150	110	255	190	150	110
5/8 - 18	210	155	160	120	290	215	160	120
3/4 - 10	325	240	255	190	460	340	255	190
3/4 - 16	365	270	285	210	515	380	285	210
7/8 - 9	490	360	380	280	745	550	380	280
7/8 - 14	530	390	420	310	825	610	420	310
1 - 8	720	530	570	420	1100	820	570	420
1 - 14	800	590	650	480	1200	890	650	480

NOTES

1. Always use the torque values listed in the above table when specific torque values are not supplied in a procedure.
2. Do NOT use these torque values in place of specified torque values in a procedure.
3. The values in the table are based on lubricated threads.
4. When a ft-lb value is less than 10, convert the ft-lb value to in-lb to obtain a better torque with an in-lb wrench.

Pipe plug torque values

Size		Torque			
Thread	Actual thread OD	In aluminum housing		In cast iron or steel housing	
in	in	Nm	ft-lb	Nm	ft-lb
1/16	0.32	5	45 lb in	15	10
1/8	0.41	15	10	20	15
1/4	0.54	20	15	25	20
3/8	0.68	25	20	35	25
1/2	0.85	35	25	55	40
3/4	1.05	45	35	75	55
1	1.32	60	45	95	75
1-1/4	1.66	75	55	115	85
1-1/2	1.90	85	65	135	100

**Thanks very much for your reading,
Want to get more information,
Please click here, Then get the complete
manual**

JustClickHere 

NOTE:

**If there is no response to click on the link above,
please download the PDF document first, and then
click on it.**

**Have any questions please write to me:
admin@servicemanualperfect.com**