



Bobcat®

Service Manual



E27z

Compact Excavator

S/N B4B911001 & Above



MAINTENANCE SAFETY



WARNING

Instructions are necessary before operating or servicing machine. Read and understand the Operation & Maintenance Manual, Operator's Handbook and signs (decals) on machine. Follow warnings and instructions in the manuals when making repairs, adjustments or servicing. Check for correct function after adjustments, repairs or service. Untrained operators and failure to follow instructions can cause injury or death.

W-2003-0807



Safety Alert Symbol: This symbol with a warning statement, means: "Warning, be alert! Your safety is involved!" Carefully read the message that follows.

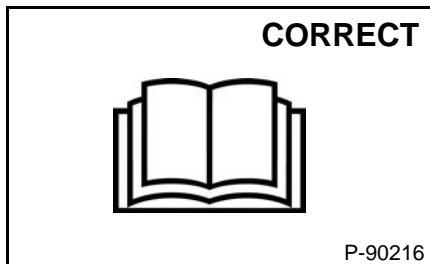

⚠ Never service the Bobcat excavator without instructions.

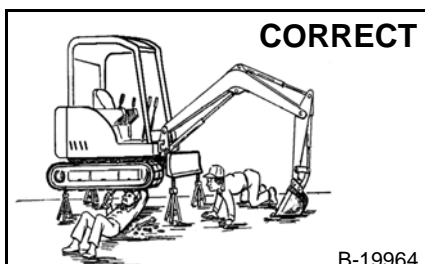

⚠ Use the correct procedure to lift and support the excavator.

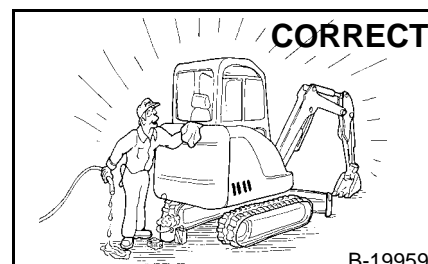

⚠ Cleaning and maintenance are required daily.

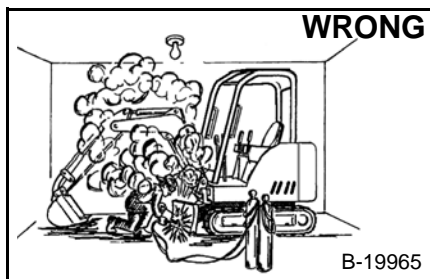

⚠ Have good ventilation when welding or grinding painted parts.
⚠ Wear dust mask when grinding painted parts. Toxic dust and gas can be produced.

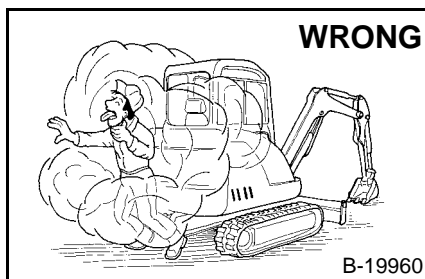

⚠ Vent exhaust to outside when engine must be run for service.
⚠ Exhaust system must be tightly sealed. Exhaust fumes can kill without warning.

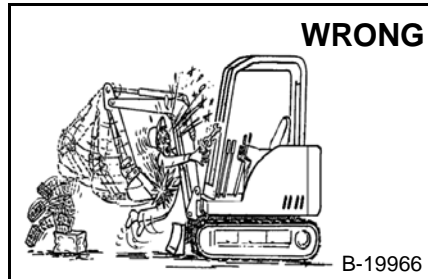

⚠ Always lower the bucket and blade to the ground before doing any maintenance.
⚠ Never modify equipment or add attachments not approved by Bobcat Company.

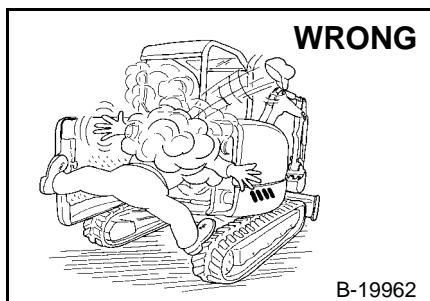

⚠ Stop, cool and clean engine of flammable materials before checking fluids.
⚠ Never service or adjust machine with the engine running unless instructed to do so in the manual.
⚠ Avoid contact with leaking hydraulic fluid or diesel fuel under pressure. It can penetrate the skin or eyes.
⚠ Never fill fuel tank with engine running, while smoking, or when near open flame.

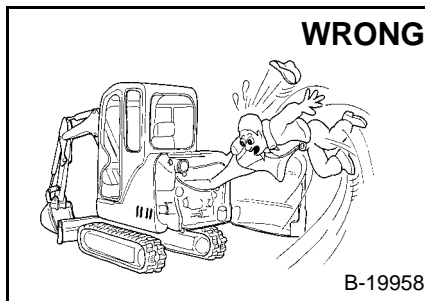

⚠ Keep body, jewelry and clothing away from moving parts, electrical contact, hot parts and exhaust.
⚠ Wear eye protection to guard from battery acid, compressed springs, fluids under pressure and flying debris when engines are running or tools are used. Use eye protections approved for type of welding.
⚠ Keep tailgate closed except for service. Close and latch tailgate before operating the excavator.

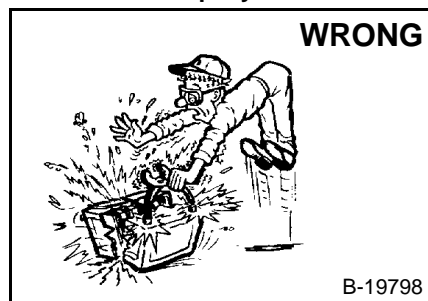

⚠ Lead-acid batteries produce flammable and explosive gases.
⚠ Keep arcs, sparks, flames and lighted tobacco away from batteries.
⚠ Batteries contain acid which burns eyes or skin on contact.
⚠ Wear protective clothing. If acid contacts body, flush well with water. For eye contact flush well and get immediate medical attention.

Maintenance procedures which are given in the Operation & Maintenance Manual can be performed by the owner / operator without any specific technical training. Maintenance procedures which are **not** in the Operation & Maintenance Manual must be performed **ONLY BY QUALIFIED BOBCAT SERVICE PERSONNEL**. Always use genuine Bobcat replacement parts. The Service Safety Training Course is available from your Bobcat dealer.

MSW28-0409



Bobcat®

CONTENTS

SAFETY AND MAINTENANCE	10-01
HYDRAULIC SYSTEM	20-01
UNDERCARRIAGE	30-01
UPPERSTRUCTURE AND SWING SECTION	40-01
ELECTRICAL SYSTEM AND ANALYSIS	50-01
ENGINE SERVICE	60-01
HEATING AND VENTILATION	70-01
SPECIFICATIONS	SPEC-01
ALPHABETICAL INDEX	1-01

**Thanks very much for your reading,
Want to get more information,
Please click here, Then get the complete
manual**

JustClickHere 

NOTE:

**If there is no response to click on the link above,
please download the PDF document first, and then
click on it.**

**Have any questions please write to me:
admin@servicemanualperfect.com**



Bobcat®

FOREWORD

FOREWORD	1-7
SAFETY INSTRUCTIONS	1-9
Avoid Silica Dust	1-9
FIRE PREVENTION	1-10
Maintenance	1-10
Operation	1-10
Electrical	1-10
Hydraulic System	1-10
Fueling	1-10
Starting	1-10
Spark Arrester Exhaust System	1-10
Welding And Grinding	1-11
Fire Extinguishers	1-11
SERIAL NUMBER LOCATIONS	1-12
Excavator Serial Number	1-12
Engine Serial Number	1-12
DELIVERY REPORT	1-13
EXCAVATOR IDENTIFICATION	1-14



Bobcat®

FOREWORD

This manual is for the Bobcat excavator mechanic. It provides necessary servicing and adjustment procedures for the Bobcat excavator and its component parts and systems. Refer to the Operation & Maintenance Manual for operating instructions, starting procedure, daily checks, etc.

A general inspection of the following items must be made after the excavator has had service or repair:

1. Check that the ROPS/TOPS/FOPS is in good condition and is not modified.

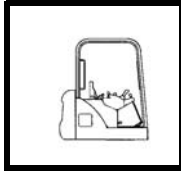

2. Check that ROPS/TOPS mounting hardware is tightened and is Bobcat approved.

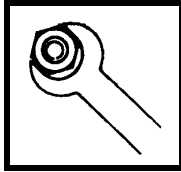

3. The seat belt must be correctly installed, functional and in good condition.

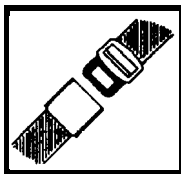

4. Machine signs (decals) must be legible and in the correct location.



5. Travel levers, control levers and foot pedals must return to neutral. Check that the pedal locks are in working order.

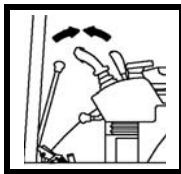

6. Check for correct function of the work lights.



7. Enclosure door latches must open and close freely.

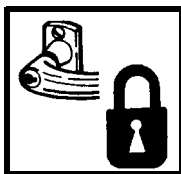

8. Attachment locking pins must function correctly and be in good condition.

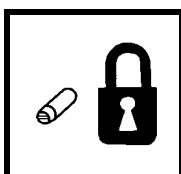

9. Safety treads must be in good condition.

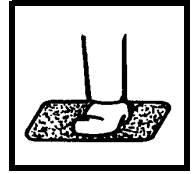

10. Check for correct function of indicator lamps.

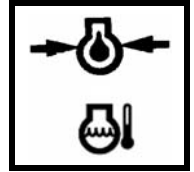

11. Check all machine fluid levels.

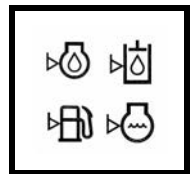

12. Inspect for fuel, oil or hydraulic fluid leaks.

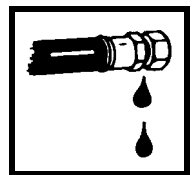

13. Lubricate the excavator.

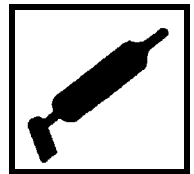

14. Check the condition of the battery and cables.

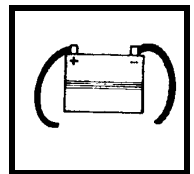

15. Inspect the air cleaner for damage or leaks. Check the condition of the element.

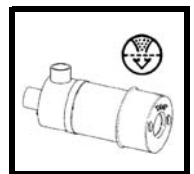

16. Check the electrical charging system.

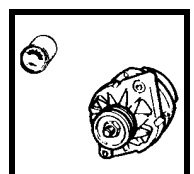

FW EXC-0617SM

17. Check tracks for wear and tension. Use only approved tracks.

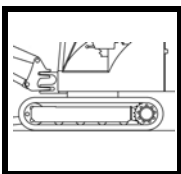

18. Inspect for loose or broken parts or connections.

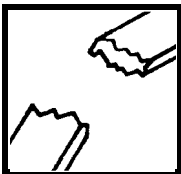

19. Check for any field modification not completed.



20. Operate the machine and check all functions.

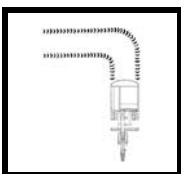

21. Check the control console interlocks for correct function.

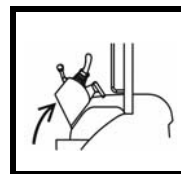

22. Inspect the X-Change™ for wear or damage. Repair or replace damaged parts.

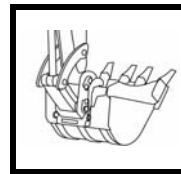

23. Check function or condition of all equipped options and accessories (examples: special applications kit, motion alarm, etc.).



24. Recommend to the owner that all necessary corrections be made before the machine is returned to service.

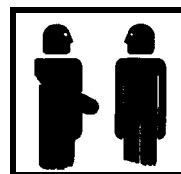

**CALIFORNIA
PROPOSITION 65 WARNING**
Diesel engine exhaust and some of its constituents are known to the state of California to cause cancer, birth defects and other reproductive harm.

SAFETY INSTRUCTIONS



Safety Alert Symbol

This symbol with a warning statement means: "Warning, be alert! Your safety is involved!" Carefully read the message that follows.



WARNING

AVOID INJURY OR DEATH

Instructions are necessary before operating or servicing machine. Read and understand the Operation & Maintenance Manual, Operator's Handbook and signs (decals) on machine. Follow warnings and instructions in the manuals when making repairs, adjustments or servicing. Check for correct function after adjustments, repairs or service. Untrained operators and failure to follow instructions can cause injury or death.

W-2003-0807

IMPORTANT

This notice identifies procedures which must be followed to avoid damage to the machine.

I-2019-0284



DANGER

The signal word DANGER on the machine and in the manuals indicates a hazardous situation which, if not avoided, will result in death or serious injury.

D-1002-1107



WARNING

The signal word WARNING on the machine and in the manuals indicates a potentially hazardous situation which, if not avoided, could result in death or serious injury.

W-2044-1107

The following publications provide information on the safe use and maintenance of the Bobcat machine and attachments:

- The Delivery Report is used to assure that complete instructions have been given to the new owner and that the machine is in safe operating condition.
- The Operation & Maintenance Manual delivered with the machine or attachment contains operating information as well as routine maintenance and service procedures. It is a part of the machine and can be stored in a container provided on the machine. Replacement Operation & Maintenance Manuals can be ordered from your Bobcat dealer.
- Machine signs (decals) instruct on the safe operation and care of your Bobcat machine or attachment. The signs and their locations are shown in the Operation & Maintenance Manual. Replacement signs are available from your Bobcat dealer.
- An Operator's Handbook fastened to the operator cab. It's brief instructions are convenient to the operator. The handbook is available from your dealer in an English edition or one of many other languages. See your Bobcat dealer for more information on translated versions.
- The Service Manual and Parts Manual are available from your dealer for use by mechanics to do shop-type service and repair work.

The dealer and owner / operator review the recommended uses of the product when delivered. If the owner / operator will be using the machine for a different application(s) he or she must ask the dealer for recommendations on the new use.

Avoid Silica Dust



Cutting or drilling concrete containing sand or rock containing quartz may result in exposure to silica dust. Use a respirator, water spray or other means to control dust.

SI EXC EMEA-1114 SM

FIRE PREVENTION



Maintenance

The machine and some attachments have components that are at high temperatures under normal operating conditions. The primary source of high temperatures is the engine and exhaust system. The electrical system, if damaged or incorrectly maintained, can be a source of arcs or sparks.

Flammable debris (leaves, straw, etc.) must be removed regularly. If flammable debris is allowed to accumulate, it can cause a fire hazard. Clean often to avoid this accumulation. Flammable debris in the engine compartment is a potential fire hazard.

The operator's area, engine compartment and engine cooling system must be inspected every day and cleaned if necessary to prevent fire hazards and overheating.

All fuels, most lubricants and some coolants mixtures are flammable. Flammable fluids that are leaking or spilled onto hot surfaces or onto electrical components can cause a fire.

Operation

Do not use the machine where exhaust, arcs, sparks or hot components can contact flammable material, explosive dust or gases.

Electrical



Check all electrical wiring and connections for damage. Keep the battery terminals clean and tight. Repair or replace any damaged part or wires that are loose or frayed.

Battery gas can explode and cause serious injury. Use the procedure in the Operation & Maintenance Manual for connecting the battery and for jump starting. Do not jump start or charge a frozen or damaged battery. Keep any open flames or sparks away from batteries. Do not smoke in battery charging area.

Hydraulic System

Check hydraulic tubes, hoses and fittings for damage and leakage. Never use open flame or bare skin to check for leaks. Hydraulic tubes and hoses must be properly routed and have adequate support and secure clamps. Tighten or replace any parts that show leakage.

Always clean fluid spills. Do not use petrol or diesel fuel for cleaning parts. Use commercial nonflammable solvents.

Fueling



Stop the engine and let it cool before adding fuel. No smoking! Do not refuel a machine near open flames or sparks. Fill the fuel tank outdoors.

Ultra Low Sulfur Diesel (ULSD) poses a greater static ignition hazard than earlier diesel formulations with higher Sulfur content. Avoid death or serious injury from fire or explosion. Consult with your fuel or fuel system supplier to ensure the delivery system is in compliance with fueling standards for proper grounding and bonding practices.

Starting

Do not use ether or starting fluids on any engine that has glow plugs or air intake heater. These starting aids can cause explosion and injure you or bystanders.

Use the procedure in the Operation & Maintenance Manual for connecting the battery and for jump starting.

Spark Arrester Exhaust System

The spark arrester exhaust system is designed to control the emission of hot particles from the engine and exhaust system, but the muffler and the exhaust gases are still hot.

Check the spark arrester exhaust system regularly to make sure it is maintained and working properly. Use the procedure in the Operation & Maintenance Manual for cleaning the spark arrester muffler (if equipped).

FIRE PREVENTION (CONT'D)

Welding And Grinding

Always clean the machine and attachment, disconnect the battery, and disconnect the wiring from the Bobcat controllers before welding. Cover rubber hoses, battery and all other flammable parts. Keep a fire extinguisher near the machine when welding.

Have good ventilation when grinding or welding painted parts. Wear dust mask when grinding painted parts. Toxic dust or gas can be produced.

Dust generated from repairing nonmetallic parts such as hoods, fenders or covers can be flammable or explosive. Repair such components in a well ventilated area away from open flames or sparks.

Fire Extinguishers

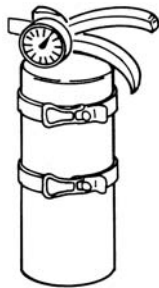

Know where fire extinguishers and first aid kits are located and how to use them. Inspect the fire extinguisher and service the fire extinguisher regularly. Obey the recommendations on the instructions plate.

SERIAL NUMBER LOCATIONS

Always use the serial number of the excavator when requesting service information or when ordering parts. Early or later models (identification made by serial number) can use different parts, or it can be necessary to use a different procedure in doing a specific service operation.

Excavator Serial Number

Figure 1

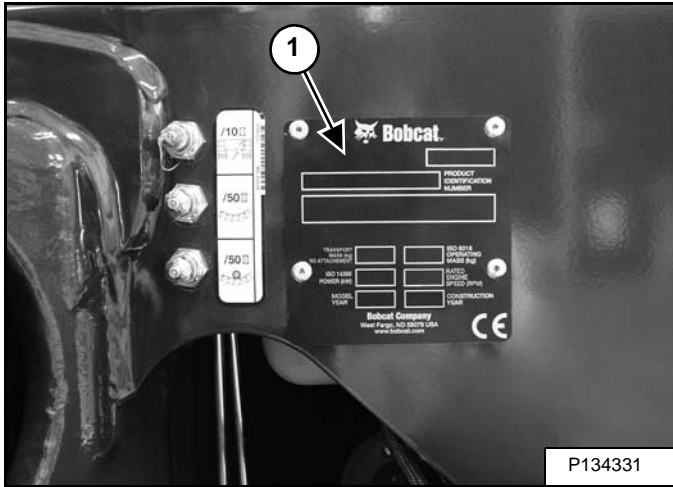

The excavator serial number plate (Item 1) is located on the frame of the machine in the location shown [Figure 1].

Figure 2

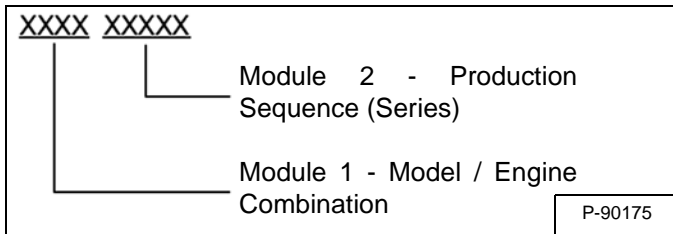

Explanation of excavator Serial Number [Figure 2]:

1. The four digit Model / Engine Combination Module number identifies the model number and engine combination.
2. The five digit Production Sequence Number identifies the order which the excavator is produced.

Engine Serial Number

Figure 3

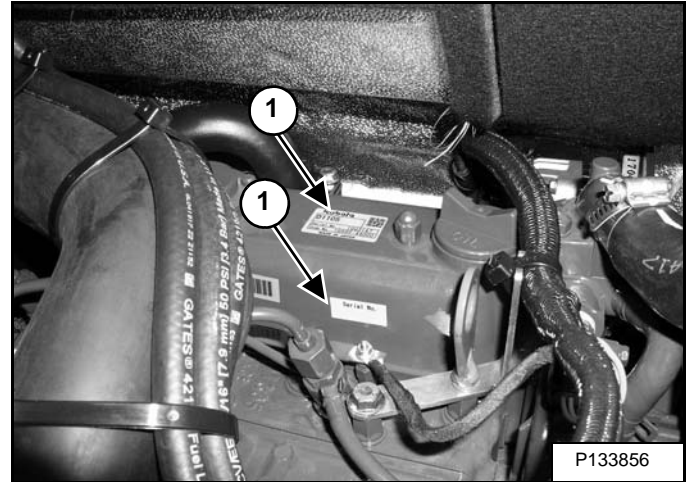

The engine serial number is located on the top cover (two locations) (Item 1) [Figure 3].

DELIVERY REPORT

Figure 4

The diagram shows a rectangular form with a border. At the top right, it is titled "DELIVERY REPORT". The form is divided into several sections. The top left section contains several horizontal lines. The top right section contains horizontal lines and a small table with two columns. The middle left section has a dark header with the word "WARNING" in white, followed by several horizontal lines. The middle right section contains several horizontal lines. The bottom section contains several horizontal lines. A small box at the bottom right of the form contains the text "B-16315".

The delivery report [Figure 4] contains a list of items that must be explained or shown to the owner or operator by the dealer when the Bobcat excavator is delivered.

The delivery report must be reviewed and signed by the owner or operator and the dealer.

EXCAVATOR IDENTIFICATION

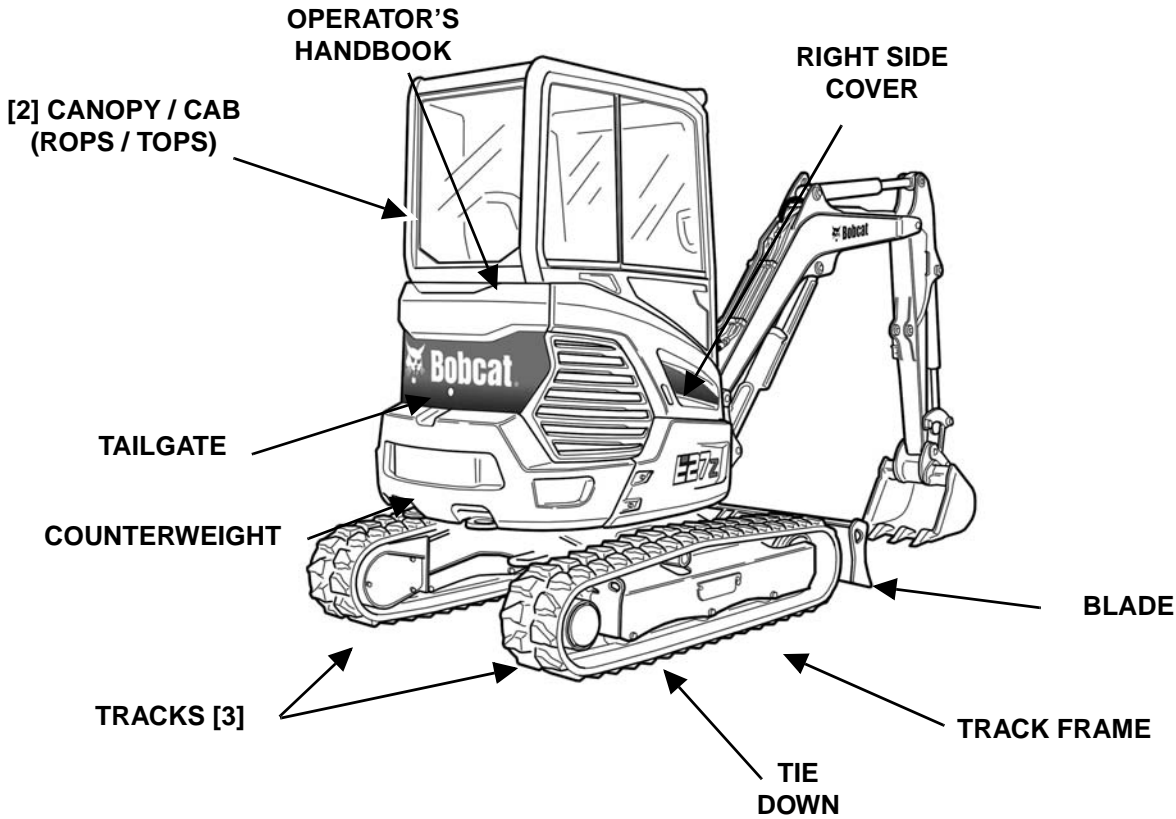
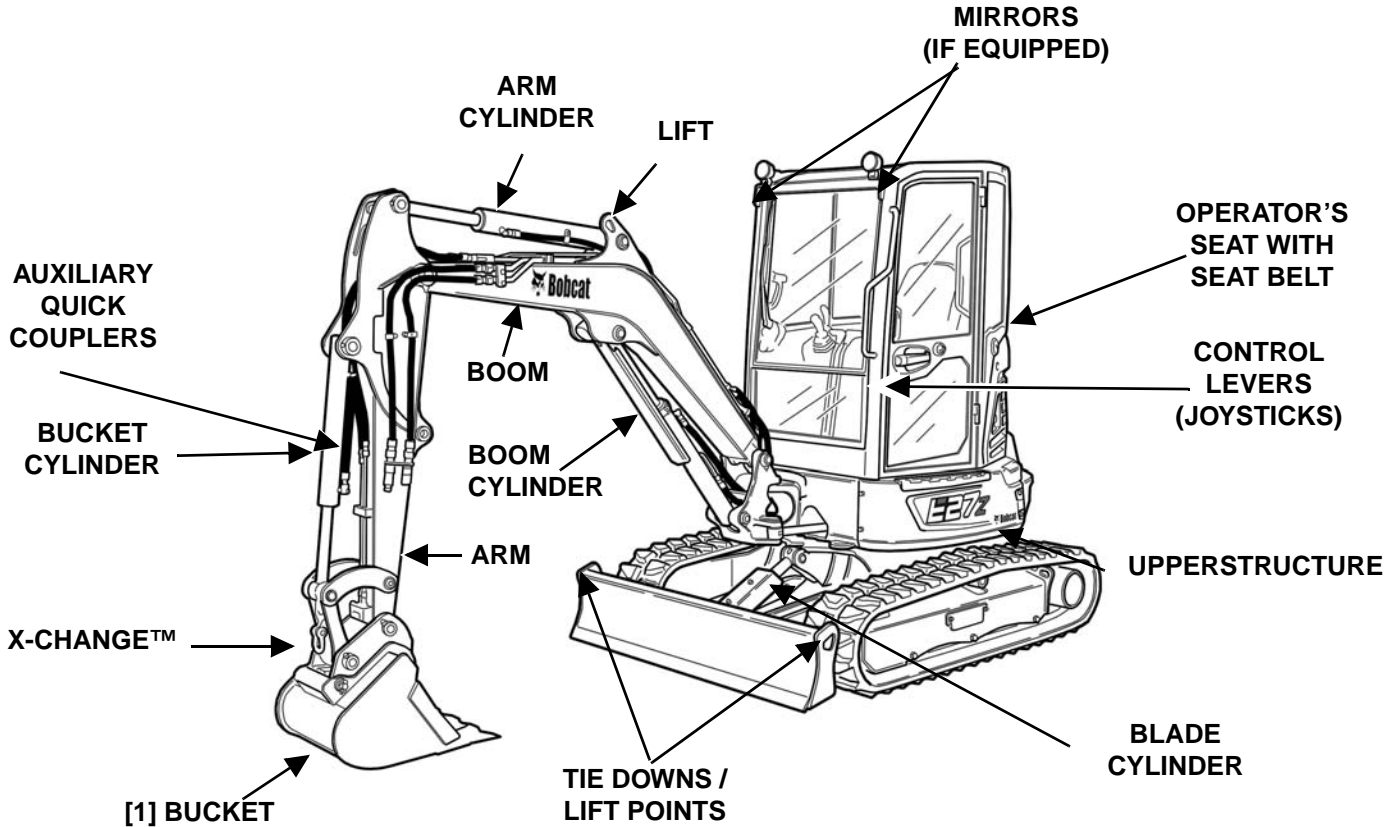

- [1] BUCKET - Several different buckets and other attachments are available from the Bobcat excavator.
- [2] ROPS, TOPS - (Roll Over Protective Structure / Tip Over Protective Structure) as standard equipment. The ROPS / TOPS meets ISO 12117-2 AND ISO 12117.
- [3] TRACKS - Optional tracks are available.

NA13926
NA13927

SAFETY AND MAINTENANCE

LIFTING AND BLOCKING THE EXCAVATOR	10-10-1
Procedure	10-10-1
LIFTING THE EXCAVATOR	10-20-1
Procedure	10-20-1
OPERATOR CAB (ROPS / TOPS / FOPS)	10-30-1
Description	10-30-1
Cab Door	10-30-2
Front Window	10-30-3
Front Wiper	10-30-4
Window Washer Reservoir	10-30-4
Right Side Window	10-30-5
Heating And Ventilation Ducting	10-30-6
OPERATOR CANOPY (ROPS / TOPS / FOPS)	10-31-1
Description	10-31-1
TRANSPORTING THE EXCAVATOR ON A TRAILER	10-40-1
Loading And Unloading	10-40-1
Fastening	10-40-2
TAILGATE	10-50-1
Opening And Closing	10-50-1
Adjusting The Latch	10-50-1
RIGHT SIDE COVER	10-60-1
Opening And Closing	10-60-1
SERVICE SCHEDULE	10-70-1
Maintenance Intervals	10-70-1
Inspection Checkbook	10-70-2
AIR CLEANER SERVICE	10-80-1
Daily Check	10-80-1
Replacing The Filters	10-80-1
ENGINE COOLING SYSTEM	10-90-1
Cleaning	10-90-1
Checking Level	10-90-2
Removing And Replacing Coolant	10-90-3

FUEL SYSTEM	10-100-1
Fuel Specifications	10-100-1
Biodiesel Blend Fuel	10-100-1
Filling The Fuel Tank	10-100-2
Fuel Filter	10-100-3
Draining The Fuel Tank	10-100-3
Removing Air From The Fuel System	10-100-4
ENGINE LUBRICATION SYSTEM	10-110-1
Checking And Adding Engine Oil	10-110-1
Engine Oil Chart	10-110-1
Removing And Replacing Oil And Filter	10-110-2
HYDRAULIC SYSTEM	10-120-1
Checking And Adding Hydraulic Fluid	10-120-1
Hydraulic / Hydrostatic Fluid Chart	10-120-2
Removing And Replacing Hydraulic Filters	10-120-2
Removing And Replacing Hydraulic Fluid	10-120-3
LUBRICATING THE EXCAVATOR	10-130-1
Lubrication Locations	10-130-1
PIVOT PINS	10-140-1
Inspection And Maintenance	10-140-1
TRAVEL MOTOR	10-150-1
Checking And Adding Oil	10-150-1
Removing And Replacing Oil	10-150-1
EMERGENCY EXIT	10-160-1
Right Side Rear Window	10-160-1
Front Window	10-160-1
SEAT BELT	10-170-1
Inspection And Maintenance	10-170-1
CONTROL CONSOLE LOCKOUTS	10-180-1
Inspection And Maintenance	10-180-1
TOWING THE EXCAVATOR	10-190-1
Procedure	10-190-1
REMOTE START TOOL KIT - MEL1563	10-200-1
Remote Start Tool - MEL1563	10-200-1
Service Tool Harness Control - MEL1565	10-200-2
Service Tool Harness Communicator - MEL1566	10-200-3

REMOTE START TOOL (SERVICE TOOL) KIT - 7217666	10-201-1
Description	10-201-1
Remote Start Tool (Service Tool) - 7022042	10-201-2
Excavator Service Tool Harness - 6689747	10-201-3
Computer Service Tool Harness - 6689746	10-201-4



Bobcat®

LIFTING AND BLOCKING THE EXCAVATOR

Procedure

Always park the machine on a level surface.

WARNING

AVOID INJURY OR DEATH

Instructions are necessary before operating or servicing machine. Read and understand the Operation & Maintenance Manual, Operator's Handbook and signs (decals) on machine. Follow warnings and instructions in the manuals when making repairs, adjustments or servicing. Check for correct function after adjustments, repairs or service. Untrained operators and failure to follow instructions can cause injury or death.

W-2003-0807

WARNING

Put jackstands under the blade and rear corners of the undercarriage before working under the machine. Failure to block up the machine may allow it to move or fall and result in injury or death.

W-2218-1195

Figure 10-10-1

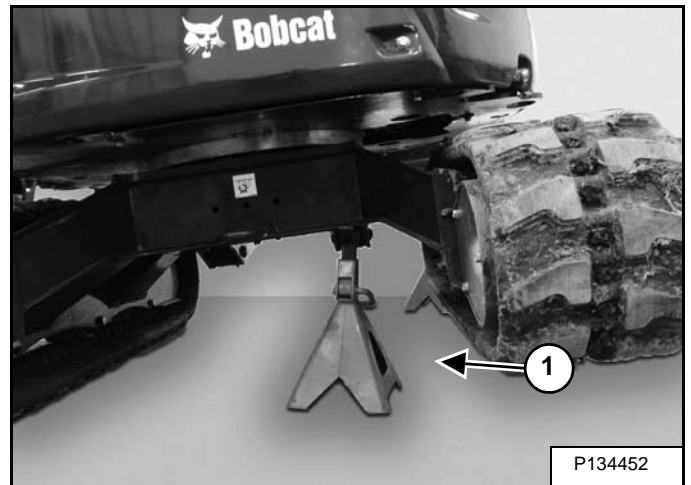
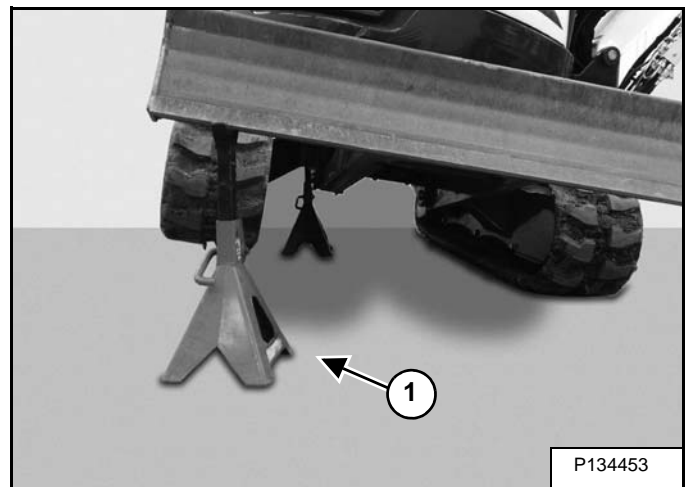

Figure 10-10-2



Raise one side of the machine (approximately 100 mm [4 in]) using the boom and arm [Figure 10-10-1] and [Figure 10-10-2].

Raise the blade fully and install jackstands under the blade and track frame (Item 1) [Figure 10-10-1] and [Figure 10-10-2]. Raise the boom until all machine weight is on the jackstands.

Repeat the procedure for the other side.

Stop the engine.



Bobcat®