

B300

B-Series



Bobcat®

Service Manual

(S/N 573111001 & Above)

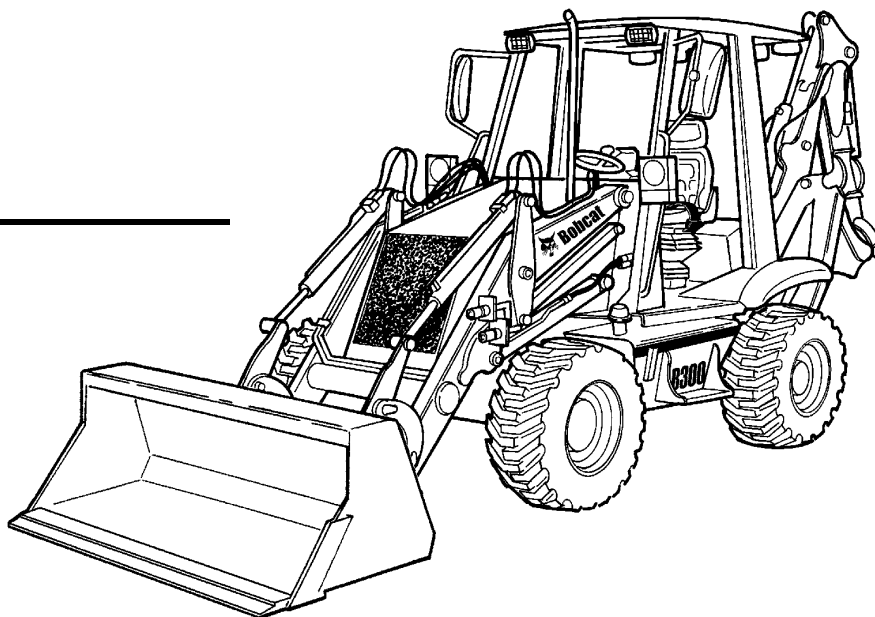

Doosan purchased Bobcat Company from Ingersoll-Rand Company in 2007. Any reference to Ingersoll-Rand Company or use of trademarks, service marks, logos, or other proprietary identifying marks belonging to Ingersoll-Rand Company in this manual is historical or nominative in nature, and is not meant to suggest a current affiliation between Ingersoll-Rand Company and Bobcat Company or the products of either.

IR Ingersoll Rand
Compact Vehicle Technologies
Printed in U.S.A.

MAINTENANCE SAFETY



WARNING

Instructions are necessary before operating or servicing machine. Read and understand the Operation & Maintenance Manual, Operator's Handbook and signs (decals) on machine. Follow warnings and instructions in the manuals when making repairs, adjustments or servicing. Check for correct function after adjustments, repairs or service. Untrained operators and failure to follow instructions can cause injury or death.

W-2003-0903



Safety Alert Symbol: This symbol with a warning statement, means: "Warning, be alert! Your safety is involved!" Carefully read the message that follows.

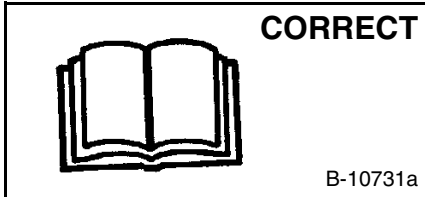

⚠ Never service the Bobcat Loader Backhoe without instructions.

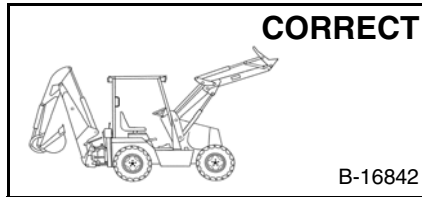

⚠ Always use an approved lift arm support device when servicing the loader backhoe with the lift arms raised. Replace the lift arm support device if damaged or missing.

⚠ Disconnecting or loosening any hydraulic tubeline, hose, fitting component, or part failure can cause lift arms or backhoe boom to drop.

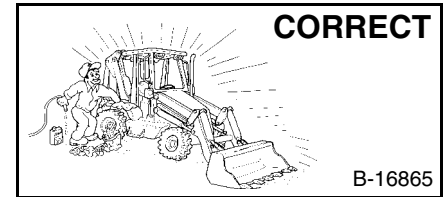

⚠ Cleaning and maintenance are required daily.

⚠ NEVER modify equipment or add attachments not approved by Bobcat.

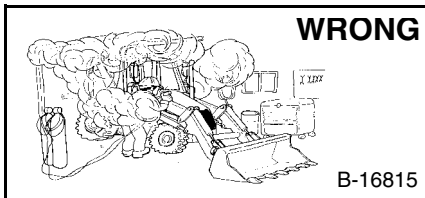

⚠ Have good ventilation when welding or grinding painted parts.

⚠ Wear dust mask when grinding painted parts. Toxic dust and gas can be produced.

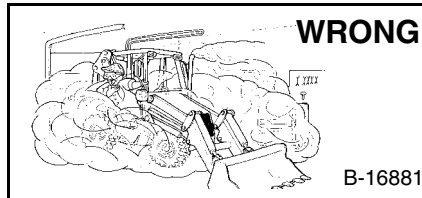

⚠ Vent exhaust to outside when engine must be run for service.

⚠ Exhaust system must be tightly sealed. Exhaust fumes can kill without warning.

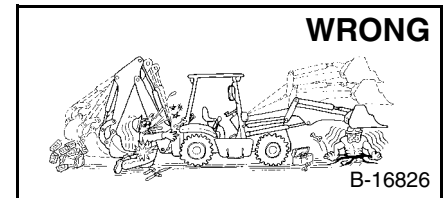

⚠ Never work on loader backhoe with lift arms raised unless supported by an approved lift arm support device.

⚠ Always lower the backhoe bucket to the ground before doing any maintenance.

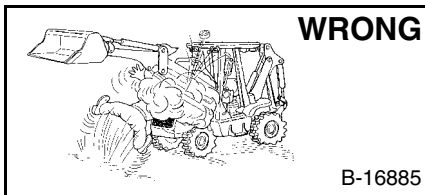

⚠ Stop, cool and clean engine of flammable materials before checking fluids.

⚠ Never service or adjust machine with the engine running unless instructed to do so in the manual.

⚠ Avoid contact with leaking hydraulic fluid or diesel fuel under pressure. It can penetrate the skin or eyes.

⚠ Never fill fuel tank with engine running, while smoking or when near open flame.

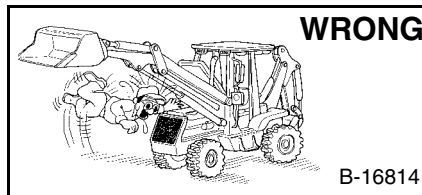

⚠ Keep body, jewelry and clothing away from moving parts, electrical contact, hot parts and exhaust.

⚠ Wear eye protection to guard from battery acid, compressed springs, fluids under pressure and flying debris when engines are running or tools are used.

⚠ Use eye protection approved for type of welding.

⚠ Keep engine cover closed except for service. Close and latch engine cover before operating the loader backhoe.



⚠ Lead-acid batteries produce flammable and explosive gases.

⚠ Keep arcs, sparks, flames and lighted tobacco away from batteries.

⚠ Batteries contain acid which burns eyes or skin on contact. Wear protective clothing. If acid contacts body, flush well with water. For eye contact flush well and get immediate medical attention.

Maintenance procedures which are given in the Operation & Maintenance Manual can be performed by the owner/operator without any specific technical training. Maintenance procedures which are **not** in the Operation & Maintenance Manual must be performed **ONLY BY QUALIFIED BOBCAT SERVICE PERSONNEL**. Always use **genuine Bobcat replacement parts**.



Bobcat®

ALPHABETICAL INDEX

AIR CLEANER	70-01	HYDRAULIC FILTER	20-01
AIR CLEANER SERVICE	10-01	HYDRAULIC FILTER HOUSING	20-01
ALTERNATOR	60-01	HYDRAULIC FLUID RESERVOIR	20-01
ALTERNATOR BELT	10-01	HYDRAULIC SYSTEM INFORMATION	20-01
APPROVED LIFT ARM SUPPORT DEVICE	10-01	HYDRAULIC/HYDROSTATIC FLUID	
ARM CYLINDER	20-01	SPECIFICATIONS	SPEC-01
ARM	50-01	HYDRAULIC/HYDROSTATIC SYSTEM	10-01
AXLE AND DIFFERENTIAL (FRONT)	40-01	HYDROSTATIC DRIVE MOTOR	30-01
AXLE AND DIFFERENTIAL (REAR)	40-01	HYDROSTATIC PUMP	30-01
AXLES (FRONT AND REAR)	10-01	HYDROSTATIC SYSTEM INFORMATION	30-01
AXLE TOE-IN	10-01	HYDROSTATIC PUMP TESTING	30-01
BACKHOE CONTROL VALVE	20-01	INSTRUMENT PANEL	60-01
BATTERY	60-01		
BOB-TACH	50-01	LIFT ARMS	50-01
BOB-TACH HAND LEVER	10-01	LIFT CYLINDER	20-01
BOOM	50-01	LIFTING AND BLOCKING THE	
BOOM CYLINDER	20-01	LOADER BACKHOE	10-01
BOOM LOCK PIN	10-01	LOADER SPECIFICATIONS	SPEC-01
BRAKE PEDAL ASSEMBLY	40-01	LOADER BACKHOE TORQUE	SPEC-01
BUCKET	50-01	LOADER CONTROL VALVE	20-01
BUCKET CYLINDER	20-01	LUBRICATING THE LOADER BACKHOE	10-01
BUCKET POSITIONING LINK	50-01		
		MAIN RELIEF VALVE	20-01
CAB LIGHTS	60-01	MASTER CYLINDER	20-01
CENTER FLOOR PANEL	50-01	MUFFLER	70-01
CONVERSIONS	SPEC-01		
		OIL COOLER	30-01
DRIVE COUPLER	70-01	OPERATOR CANOPY	50-01
DRIVESHAFT	40-01	OPERATOR SEAT	50-01
DROP BOX	40-01		
		PARKING BRAKE	40-01
ELECTRICAL SYSTEM INFORMATION	60-01	PARKING BRAKE HOUSING	40-01
ENCLOSED CAB	50-01	PORT RELIEF VALVE	
ENGINE	70-01	(BACKHOE CONTROL VALVE)	20-01
ENGINE COMPONENTS AND TESTING	70-01	PORT RELIEF VALVE	
ENGINE COOLING SYSTEM	10-01	(LOADER CONTROL VALVE)	20-01
ENGINE COVER	10-01, 50-01		
ENGINE LUBRICATION SYSTEM	10-01	OIL COOLER/RADIATOR	70-01
ENGINE SIDE COVERS	50-01	REAR AXLE	40-01
ENGINE SPECIFICATIONS	SPEC-01	RECONDITIONING THE ENGINE	70-01
ENGINE SPEED CONTROL	70-01		
		SERVICE BRAKE	40-01
FENDER	50-01	SERVICE SCHEDULE	10-01
FLOOR PANELS	50-01	STABILIZER	50-01
FLYWHEEL	70-01	STABILIZER CYLINDER	20-01
FLYWHEEL HOUSING	70-01	STEERING ANGLE ADJUSTMENT	
FRONT AXLE	40-01	(FRONT AXLE)	40-01
FRONT LIGHTS	60-01	STEERING ANGLE ADJUSTMENT (REAR AXLE)	40-01
FUEL LEVEL SENDER	60-01	STEERING CYLINDER (FRONT & REAR)	20-01
FUEL SYSTEM	10-01	STEERING PUMP	20-01
FUEL TANK	50-01	STEERING VALVE	20-01
		STARTER	60-01
GEAR PUMP	20-01	SWING CYLINDER	20-01
GRILL	50-01		
GRILL FRAME	50-01		

**Thanks very much for your reading,
Want to get more information,
Please click here, Then get the complete
manual**

JustClickHere 

NOTE:

**If there is no response to click on the link above,
please download the PDF document first, and then
click on it.**

**Have any questions please write to me:
admin@servicemanualperfect.com**

ALPHABETICAL INDEX (CONT'D)

SWING FRAME	50-01
TILT CYLINDER	20-01
TIRE MAINTENANCE	10-01
TORQUE SPECIFICATIONS FOR BOLTS.....	SPEC-01
TOWING THE LOADER BACKHOE	10-01
TRANSPORTING THE LOADER BACKHOE.....	10-01
TRAVEL PEDAL	70-01
TROUBLESHOOTING.....	70-01
TURN INDICATOR LIGHTS (FRONT).....	60-01
TURN INDICATOR LIGHTS (REAR).....	60-01
X-CHANGE™	50-01

CONTENTS

FOREWORD.....	II
SAFETY INSTRUCTIONS	V
SERIAL NUMBER LOCATION	IX
DELIVERY REPORT.....	X
LOADER BACKHOE IDENTIFICATION	XI
SAFETY AND MAINTENANCE.....	10-01
HYDRAULIC SYSTEM	20-01
HYDROSTATIC SYSTEM.....	30-01
DRIVE SYSTEM	40-01
MAIN FRAME	50-01
ELECTRICAL SYSTEM AND ANALYSIS	60-01
ENGINE SERVICE	70-01
SPECIFICATIONS.....	SPEC-01

**SAFETY &
MAINTENANCE**

**HYDRAULIC
SYSTEM**

**HYDROSTATIC
SYSTEM**

**DRIVE
SYSTEM**

MAIN FRAME

**ELECTRICAL
SYSTEM &
ANALYSIS**

**ENGINE
SERVICE**

SPECIFICATIONS

FOREWORD

This manual is for the Bobcat loader mechanic. It provides necessary servicing and adjustment procedures for the Bobcat loader and its component parts and systems. Refer to the Operation & Maintenance Manual for operating instructions, Starting procedure, daily checks, etc.

A general inspection of the following items must be made after the loader has had service or repair:

1. Check that ROPS mounting hardware is tightened and is Bobcat approved.

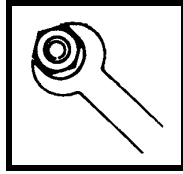

2. The seat belt must be correctly installed, functional and in good condition.

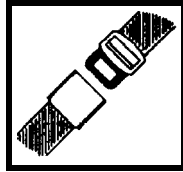

3. Check lift arm support device, replace if damaged.

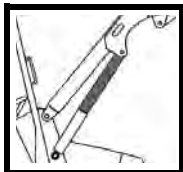

4. Machine signs must be legible and in the correct location.



5. Foot pedal must return to neutral.



6. Check for correct function of the work lights



7. The parking brake must function correctly.

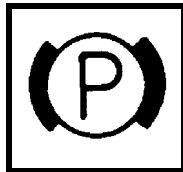

8. Enclosure door latches must open and close freely.

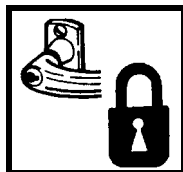

9. Bob-Tach wedges and linkages must function correctly and be in good condition.

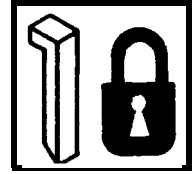

10. Safety treads must be in good condition.

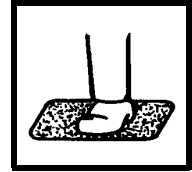

11. Check for correct function of indicator lamps (Optional on some models).

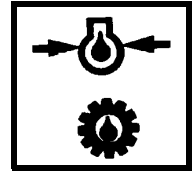

12. Check hydraulic fluid level, engine oil level and fuel supply.

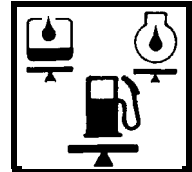

13. Inspect for fuel, oil or hydraulic fluid leaks.

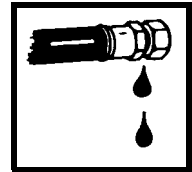

14. Lubricate the loader backhoe.



15. Check the condition of the battery and cables.

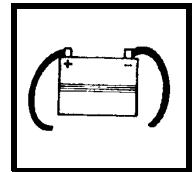

16. Inspect the air cleaner for damage or leaks. Check the condition of the element.

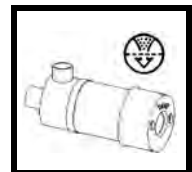

17. Check the electrical charging system.

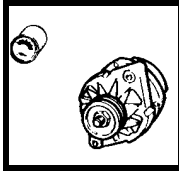

20. Operate the loader and check all functions.



18. Check tires for wear and pressure.

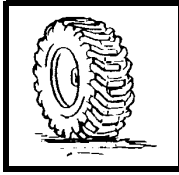

21. Check for any field modification not completed.



19. Inspect for loosen or broken parts or connections.

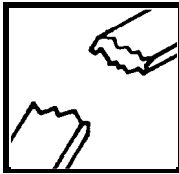

22. Recommend to the owner that all necessary corrections be made before the machine is returned to service.

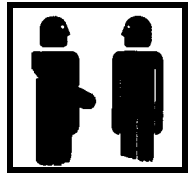

**CALIFORNIA
PROPOSITION 65 WARNING**
Diesel engine exhaust and some of its constituents are known to the State of California to cause cancer, birth defects and other reproductive harm.



Bobcat®

SAFETY INSTRUCTIONS



Safety Alert Symbol

This symbol with a warning statement means:
“Warning, be alert! Your safety is involved!”
Carefully read the message that follows.



WARNING

Instructions are necessary before operating or servicing machine. Read and understand the Operation & Maintenance Manual, Operator's Handbook and signs (decals) on machine. Follow warnings and instructions in the manuals when making repairs, adjustments or servicing. Check for correct function after adjustments, repairs or service. Untrained operators and failure to follow instructions can cause injury or death.

W-2003-0903



WARNING

Warnings on the machine and in the manuals are for your safety. Failure to obey warnings can cause injury or death.

W-2044-1285

IMPORTANT

This notice identifies procedures which must be followed to avoid damage to the machine.

I-2019-0284

The following publications provide information on the safe use and maintenance of the Bobcat machine and attachments:

- The Delivery Report is used to assure that complete instructions have been given to the new owner and that the machine is in safe operating condition.
- The Operation & Maintenance Manual delivered with the machine or attachment contains operating information as well as routine maintenance and service procedures. It is a part of the machine and can be stored in a container provided on the machine. Replacement Operation & Maintenance Manuals can be ordered from your Bobcat dealer.
- Machine signs (decals) instruct on the safe operation and care of your Bobcat machine or attachment. The signs and their locations are shown in the Operation & Maintenance Manual. Replacement signs are available from your Bobcat dealer.
- An Operator's Handbook fastened to the operator cab. It's brief instructions are convenient to the operator. The handbook is available from your dealer in an English edition or one of many other languages. See your Bobcat dealer for more information on translated versions.
- The AEM Safety Manual delivered with the machine gives general safety information.
- The Service Manual and Parts Manual are available from your dealer for use by mechanics to do shop-type service and repair work.
- The Loader Backhoe Operator Training Course is available through your local dealer or at www.training.bobcat.com or www.bobcat.com. This course is intended to provide rules and practices of correct operation of the Loader Backhoe.
- The Loader Backhoe Safety Video is available from your Bobcat dealer or at www.training.bobcat.com or www.bobcat.com.

SI LB-0206 SM

SAFETY INSTRUCTIONS (CONT'D)

The dealer and owner/operator review the recommended uses of the product when delivered. If the owner/operator will be using the machine for a different application(s) he or she must ask the dealer for recommendations on the new use.



Call Before You Dig

1-888-258-0808

When you call, you will be directed to a location in your state/city for information about buried lines (telephone, cable TV, water, sewer, gas, etc.)

SAFETY INSTRUCTIONS (CONT'D)

Fire Prevention

The machine and attachments have components that are at high temperature under normal operating conditions. The primary source of high temperatures is the engine and exhaust system. The electrical system, if damaged or incorrectly maintained, can be a source of arcs or sparks.

Flammable debris (leaves, straw, etc.) must be removed regularly. If flammable debris is allowed to accumulate, it will increase fire hazard. Clean often to avoid this accumulation. Flammable debris in the engine compartment is a potential hazard.

The spark arrestor muffler is designed to control the emission of hot particles from the engine and exhaust system, but the muffler and the exhaust gases are still hot.

- Do not use the machine where exhaust, arcs, sparks or hot components can contact flammable material, explosive dust or gases.
- The operator cab, engine compartment, and engine cooling system must be inspected every day and cleaned if necessary to prevent fire hazard and overheating.
- Check all electrical wiring and connections for damage. Keep the battery terminals clean and tight. Repair or replace any damaged part.
- Check fuel and hydraulic tubes, hoses and fittings for damage and leakage. Never use open flame or bare skin to check for leaks. Tighten or replace any parts that show leakage. Always clean fluid spills. Do not use gasoline or diesel fuel for cleaning parts. Use commercial nonflammable solvents.
- Do not use ether or starting fluids on any engine which has glow plugs. These starting aids can cause explosion and injure you or bystanders.
- Always clean the machine, disconnect the battery, and disconnect the wiring from the controllers before welding. Cover rubber hoses, battery and all other flammable parts. Keep a fire extinguisher near the machine when welding. Have good ventilation when grinding or welding painted parts. Wear a dust mask when grinding painted parts. Toxic dust or gas can be produced.
- Stop the engine and let it cool before adding fuel. **NO SMOKING!**

- Use the procedure in the Operation & Maintenance Manual for connecting the battery and for jump starting.
- Use the procedure in the Operation & Maintenance Manual for cleaning the spark arrestor muffler (if equipped).

Figure 1

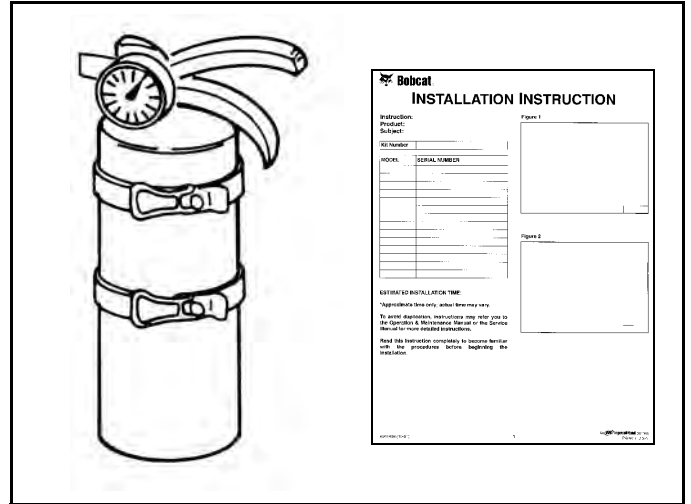

- Know where fire extinguishers and first aid kits are located and how to use them. Fire extinguishers are available from your Bobcat dealer [Figure 1].



Bobcat®

SERIAL NUMBER LOCATION

Always use the serial number of the loader backhoe when requesting service information or when ordering parts. Early or later models (identification made by serial number) may use different parts, or it may be necessary to use a different procedure in doing a specific service operation.

Loader Backhoe Serial Number

Figure 1

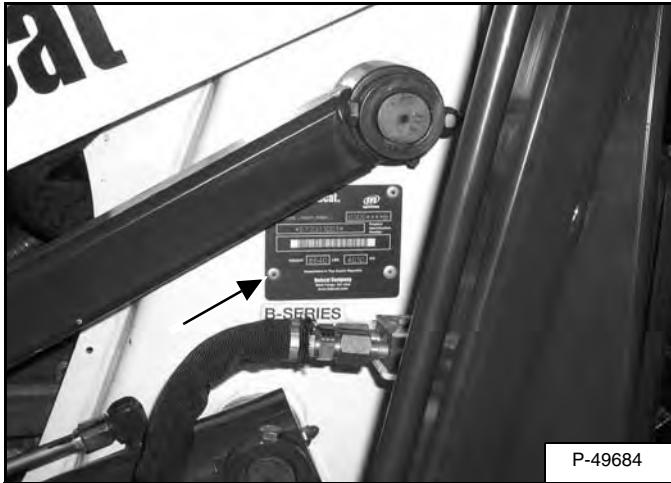

The loader backhoe serial number plate is located under the loader lift arm on the left side [Figure 1].

Explanation of loader Serial Number:

XXXX	XXXXX
Model 1.-Model/ Engine Combination	Model 2.-Production Sequence (Series)

1. The four digit Model/Engine Combination Module number identifies the model number and engine combination.
2. The five digit Production Sequence Number identifies the order which the loader is produced.

Engine Serial Number

Figure 2



The engine serial number is located on the valve cover at the front of the engine [Figure 2].

DELIVERY REPORT

Figure 3

The diagram shows a form layout for a delivery report. It includes a title 'DELIVERY REPORT' at the top right, a 'WARNING' section with a black header, and various sections of horizontal lines representing text input fields. A small box at the bottom right contains the number 'B-16315'.

The Delivery Report must be filled out by the dealer and signed by the owner or operator when the Bobcat loader backhoe is delivered. An explanation of the form must be given to the owner. Make sure it is filled out completely [Figure 3].

LOADER BACKHOE IDENTIFICATION

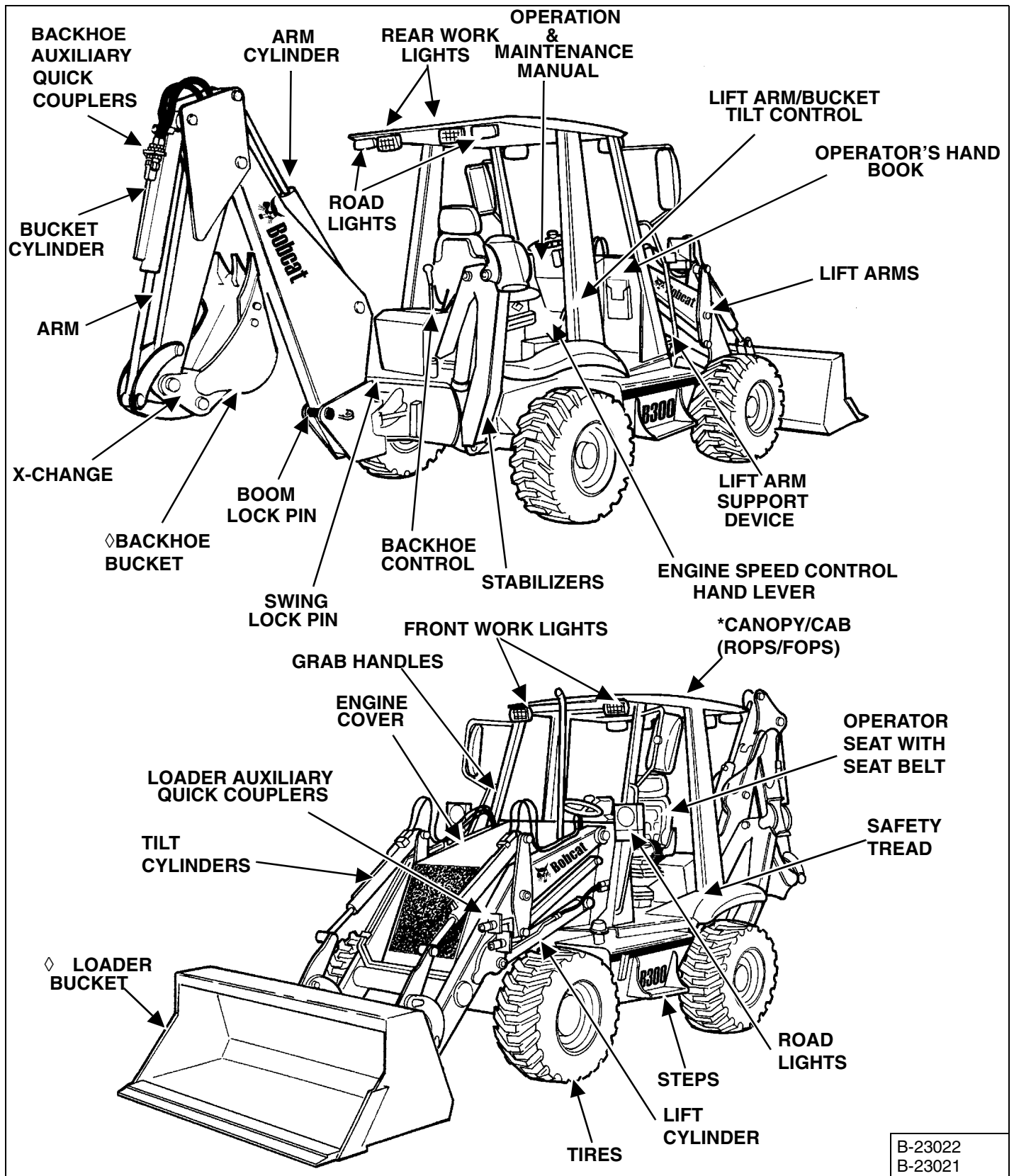

◇ BUCKET - Several different buckets and other attachments are available for the Bobcat loader backhoe.
 * Roll Over Protective Structure (ROPS) per ISO 3471 and Falling Object Protective Structure (FOPS) per ISO 3449, Level I and Level II.



Bobcat®

SAFETY AND MAINTENANCE

AIR CLEANER SERVICE 10-80-1
 Replacing The Filter. 10-80-1

ALTERNATOR BELT 10-160-1
 Adjusting The Alternator Belt 10-160-1

APPROVED LIFT ARM SUPPORT DEVICE 10-20-1
 Installing The Approved Lift Arm Support Device 10-20-1
 Removing The Approved Lift Arm Support Device 10-20-2

AXLES (FRONT AND REAR) 10-130-1
 Checking Oil Level (Front Axle) 10-130-2
 Checking Oil Level (Planetary Carrier) 10-130-1
 Checking Oil Level (Rear Axle) 10-130-2
 Draining Oil (Front Axle) 10-130-2
 Draining Oil (Planetary Carrier) 10-130-1
 Draining Oil (Rear Axle) 10-130-2

AXLE TOE-IN 10-60-1
 Procedure 10-60-1

BOB-TACH HAND LEVER 10-150-1
 Inspection And Maintenance 10-150-1

BOOM LOCK PIN 10-140-1
 Engaging And Disengaging The Pin 10-140-1

ENGINE COOLING SYSTEM 10-90-1
 Checking Coolant Level 10-90-1
 Cleaning The Cooling System 10-90-1
 Coolant Replacement 10-90-1

ENGINE COVER. 10-30-1

ENGINE LUBRICATION SYSTEM 10-110-1
 Checking Engine Oil 10-110-1
 Oil Chart. 10-110-1
 Replacing The Oil And Filter 10-110-2

FUEL SYSTEM 10-100-1
 Filling The Fuel Tank 10-100-1
 Fuel Filter. 10-100-1
 Fuel Specifications. 10-100-1
 Removing Air From The Fuel System 10-100-3

Continued On Next Page

SAFETY AND MAINTENANCE

HYDRAULIC/HYDROSTATIC SYSTEM	10-120-1
Checking And Adding Fluid	10-120-1
Cleaning The Oil Cooler/Radiator	10-120-3
Replacing Hydraulic Fluid	10-120-6
Replacing Hydraulic/Hydrostatic Filter	10-120-3
LIFTING AND BLOCKING THE LOADER BACKHOE	10-10-1
Procedure	10-10-1
LUBRICATING THE LOADER BACKHOE	10-170-1
SERVICE SCHEDULE	10-70-1
Chart	10-70-1
TIRE MAINTENANCE	10-180-1
Mounting	10-180-1
Tire Pressure	10-180-1
Wheel Nuts	10-180-1
TOWING THE LOADER BACKHOE	10-50-1
Procedure	10-50-1
TRANSPORTING THE LOADER BACKHOE	10-40-1
Procedure	10-40-1

LIFTING AND BLOCKING THE LOADER BACKHOE

Procedure

WARNING

Instructions are necessary before operating or servicing machine. Read and understand the Operation & Maintenance Manual, Handbook and signs (decals) on machine. Follow warnings and instructions in the manuals when making repairs, adjustments or servicing. Check for correct function after adjustments, repairs or service. Untrained operators and failure to follow instructions can cause injury or death.

W-2003-0199

Figure 10-10-1

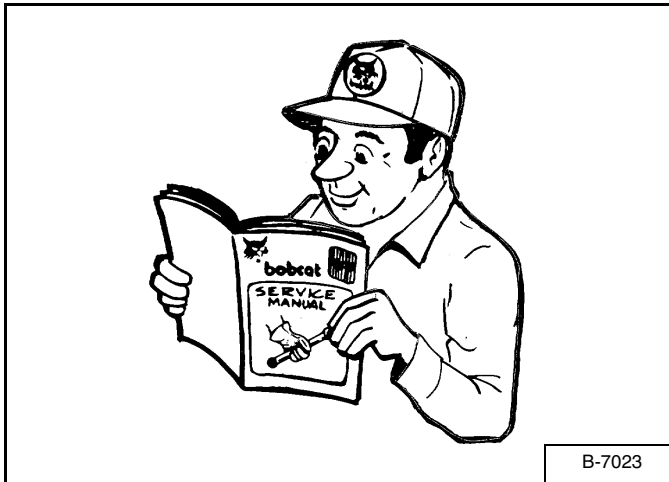

Read the removal and installation, disassembly and assembly, etc., completely to become familiar with the procedure before beginning [Figure 10-10-1].

Always park the loader backhoe on a level surface.

Stop the engine.

WARNING

Put jackstands under the front and rear axle before running the engine for service. Failure to use jackstands can allow the machine to fall or move and cause injury or death.

W-2461-0303

Figure 10-10-2

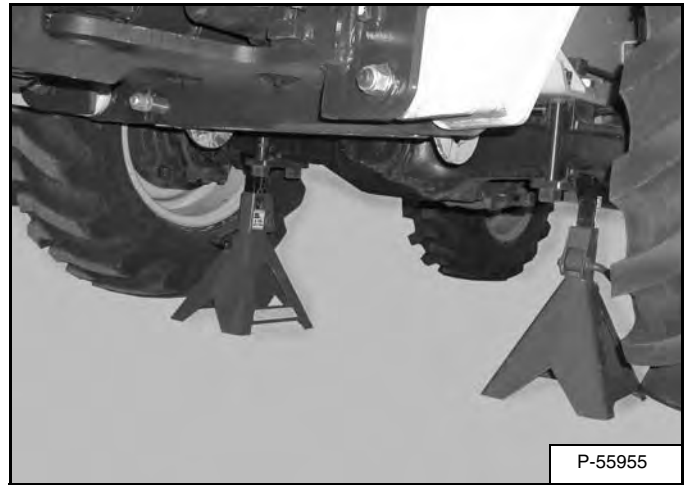

Lift the rear of the loader backhoe and install jackstands [Figure 10-10-2].

Figure 10-10-3



NOTE: Loader lift arms are raised for photo clarity.

Lift the front of the loader backhoe and put jackstands under the axle [Figure 10-10-3].

Note: Make sure the jackstands do not touch the tires.



Bobcat®