

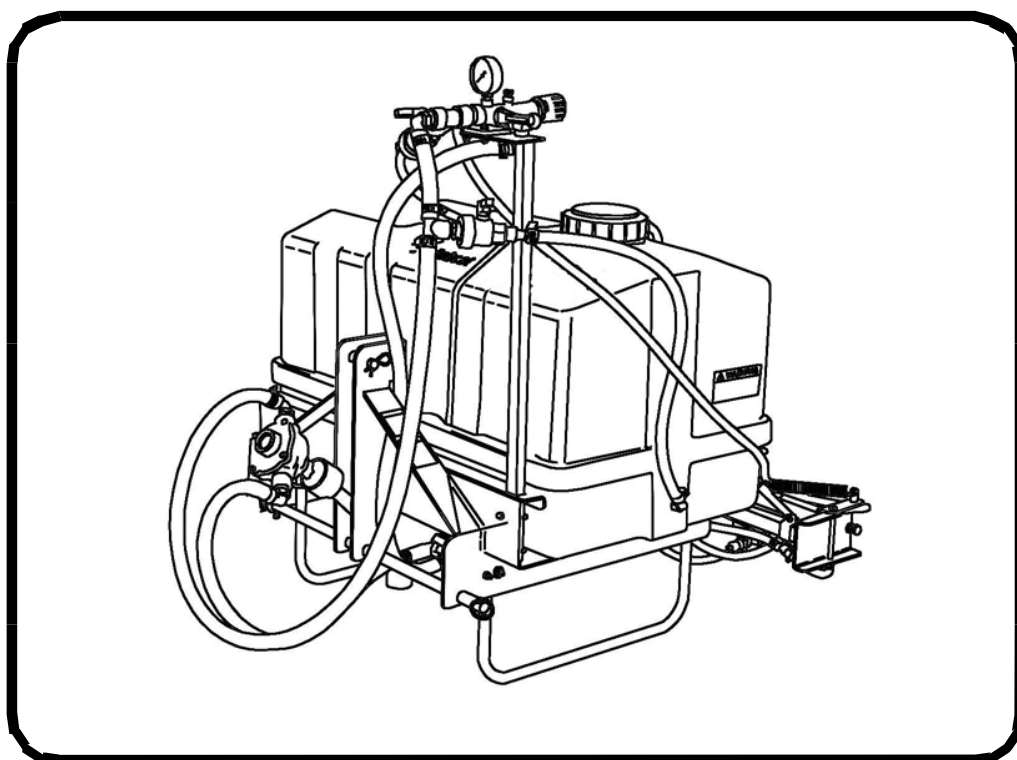

Service Manual

Three-Point PTO Sprayer

(3 PT Sprayer) S/N ABKT00101 & Above



MAINTENANCE SAFETY



WARNING







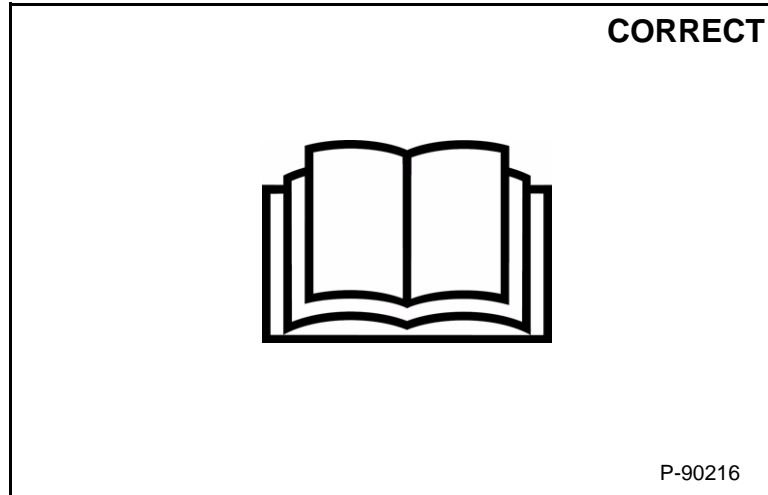

Instructions are necessary before operating or servicing machine. Read and understand the Operation & Maintenance Manual, Operator's Handbook and signs (decals) on machine. Follow warnings and instructions in the manuals when making repairs, adjustments or servicing. Check for correct function after adjustments, repairs or service. Untrained operators and failure to follow instructions can cause injury or death.

W-2003-0807



Safety Alert Symbol: This symbol with a warning statement, means: "Warning, be alert! Your safety is involved!" Carefully read the message that follows.



-  Never service attachments / implements without instructions. See Operation & Maintenance Manual and Attachment / Implement Service Manual.
-  Cleaning and maintenance are required daily.
-  Never service or adjust attachment / implement with the engine running unless instructed to do so in manual.
-  Always lower the attachment / implement to the ground before lubricating or servicing.
-  Avoid contact with leaking hydraulic fluid or diesel fuel under pressure. It can penetrate skin or eyes.
-  Stop, cool and clean engine of flammable materials before checking fluids.
-  Keep body, loose objects and clothing away from moving parts, electrical contacts, hot parts and exhaust.
-  Safety glasses are needed for eye protection from electrical arcs, battery acid, compressed springs, fluids under pressure and flying debris or when tools are used. Use eye protection approved for type of welding.



Bobcat®

CONTENTS

SAFETY & MAINTENANCE	10-01
MAIN FRAME	20-01
SPECIFICATIONS	SPEC-01
ALPHABETICAL INDEX	INDEX-01



Bobcat®

FOREWORD

SERIAL NUMBER LOCATION	1-7
Implement Serial Number Location	1-7
DELIVERY REPORT	1-7
IMPLEMENT IDENTIFICATION	1-8
IMPLEMENT SIGNS (DECALS)	1-9



Bobcat®

SERIAL NUMBER LOCATION

Implement Serial Number Location

Figure 1

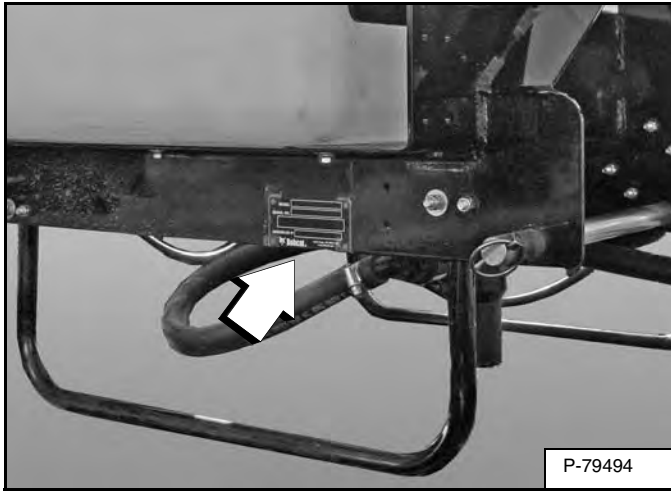

Always use the serial number of the three-point PTO sprayer when requesting service information or when ordering parts. Early or later models (identification made by serial number) may use different parts, or it may be necessary to use a different procedure in doing a specific service operation [Figure 1].

DELIVERY REPORT

Figure 2

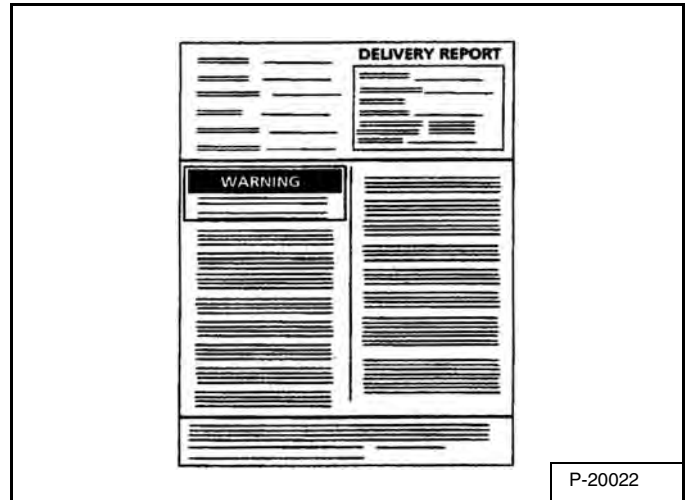

The delivery report must be filled out by the dealer and signed by the owner or operator when the three-point PTO sprayer is delivered. An explanation of the form must be given to the owner. Make sure it is filled out completely [Figure 2].

IMPLEMENT IDENTIFICATION

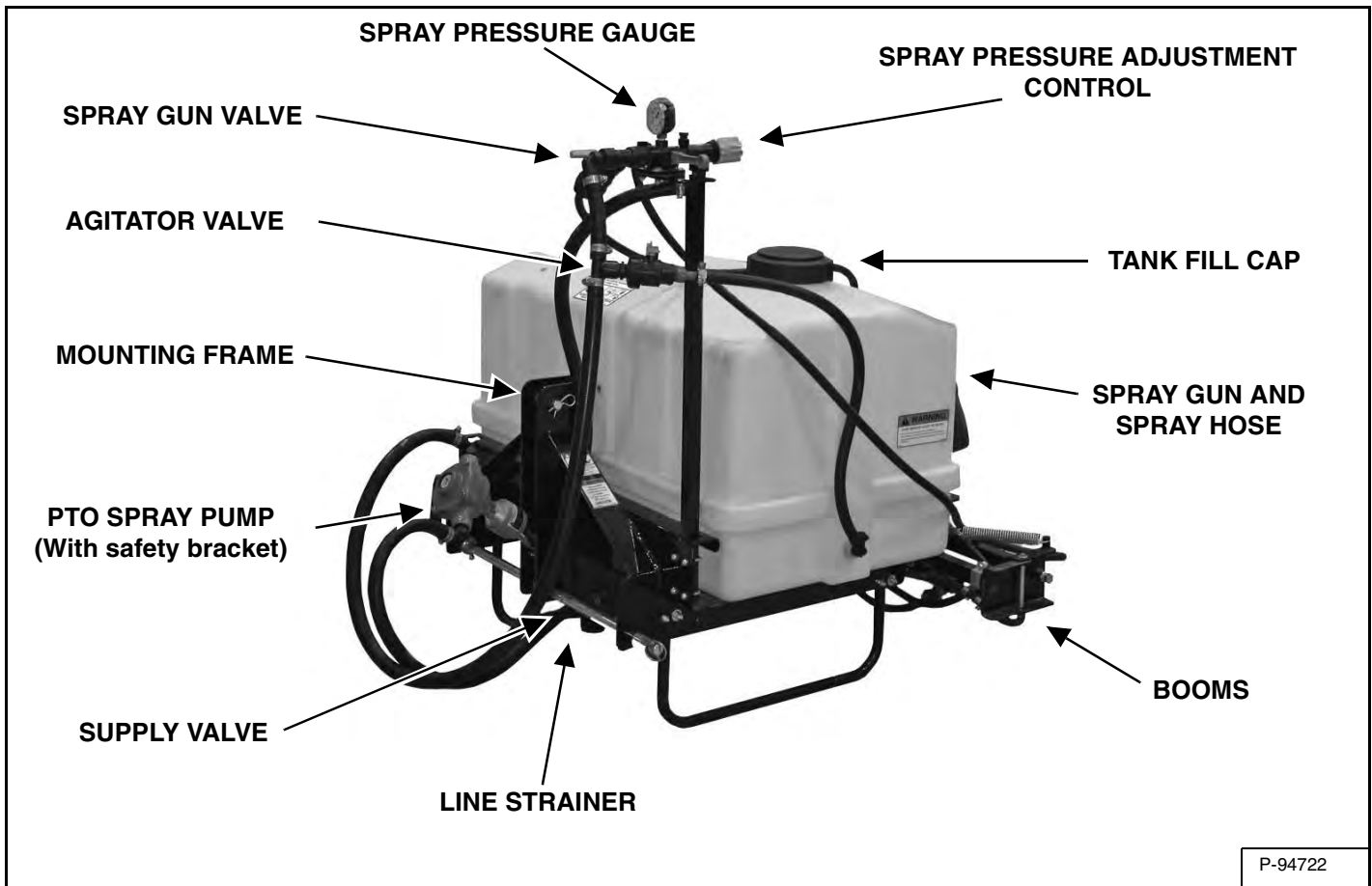

IMPLEMENT SIGNS (DECALS)

WARNING

ROTATING PARTS CAN CAUSE SERIOUS INJURY OR DEATH

- Properly install the PTO pump bracket on the compact tractor.



CT70E MODULES
ALL OTHER MODULES

SEE IMPLEMENT OPERATION & MAINTENANCE MANUAL FOR MORE INFORMATION

7169169

WARNING

EXPOSURE TO CHEMICALS CAN CAUSE SERIOUS INJURY OR DEATH

- Read and follow chemical manufacturer's instructions for safe personal protective equipment. The label is not a substitute for complete protective equipment.
- Wear personal protective equipment as recommended by chemical manufacturer.
- Do not burn or store contaminated equipment so clothing is safe.
- Keep safe from air/pressure lines.
- Check with qualified operators for proper design of hazardous situations.
- Agricultural chemicals are hazardous. Improper use can cause serious injury or death. Avoid contact with skin, eyes, nose, mouth.
- Follow instructions from manufacturer label for permit, apply and handle some chemicals.
- SEE OPERATION AND MAINTENANCE MANUAL FOR MORE INSTRUCTIONS.

7105344

WARNING

AVOID SERIOUS INJURY OR DEATH

- Fold and secure spray booms for transport.
- Drive slowly on slopes and rough ground when turning.
- Keep bystanders clear of machine and spray boom before operating.

7105345 (2)



7140614 (2)

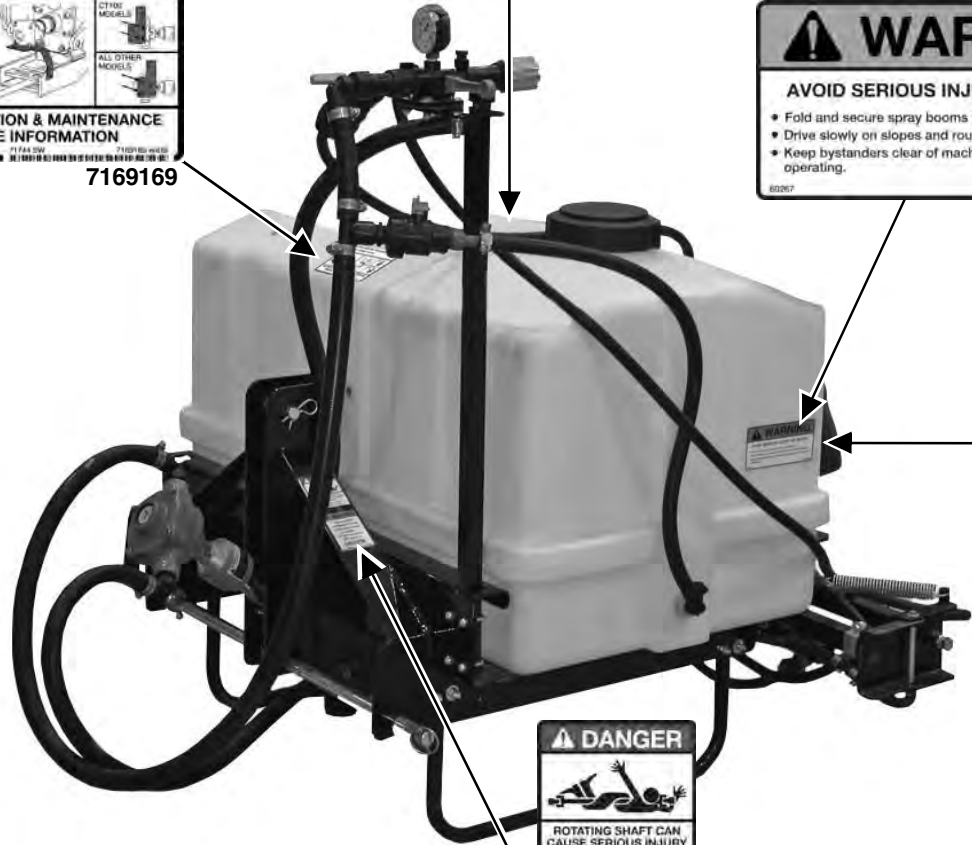

DANGER



ROTATING SHAFT CAN CAUSE SERIOUS INJURY OR DEATH

Keep shields and guards in place

WARNING

Overspeeding implement PTO can cause serious injury or death. Do NOT exceed the PTO speed of **540 RPM.**

7139188 (2)



Bobcat®

SAFETY & MAINTENANCE

TROUBLESHOOTING	10-10-1
Chart	10-10-1
REMOVAL AND INSTALLATION	10-20-1
Line Strainer	10-20-1
IMPLEMENT STORAGE AND RETURN TO SERVICE	10-30-1
Storage	10-30-1
Return to Service	10-30-1
DAILY INSPECTION	10-40-1
Implement Mounting Frame	10-40-1
Three-Point Hitch	10-40-1
Hoses	10-40-2
Nozzles	10-40-2



Bobcat®

TROUBLESHOOTING

Chart

PROBLEM	CAUSE	CORRECTION
Low Pressure	Plugged filter.	Clean filter.
Pump Does Not Start	Rear PTO not engaged.	Engage rear PTO.
	Tank empty.	Fill tank.
Spray Gun Does Not Work	Valve not ON.	Turn valve ON.
	Plugged filter.	Clean filter.



Bobcat®

REMOVAL AND INSTALLATION

Line Strainer

WARNING

The spray tank and system must be emptied of chemical mixture and flushed with clean water before servicing the spray system or spraying components.

W-2213-1095

WARNING

Do not spill chemicals on skin or clothing. If chemicals are spilled, remove contaminated clothing immediately and wash skin (and clothing) thoroughly with soap and water. Wash hands and face with soap and water and change clothing after spraying.

W-2208-0995

WARNING

Always read the label before using chemicals. Follow the instructions from the chemical manufacturer on how to select, use and handle each chemical. Note protection information each time before opening the container.

W-2209-0995

Figure 10-20-1

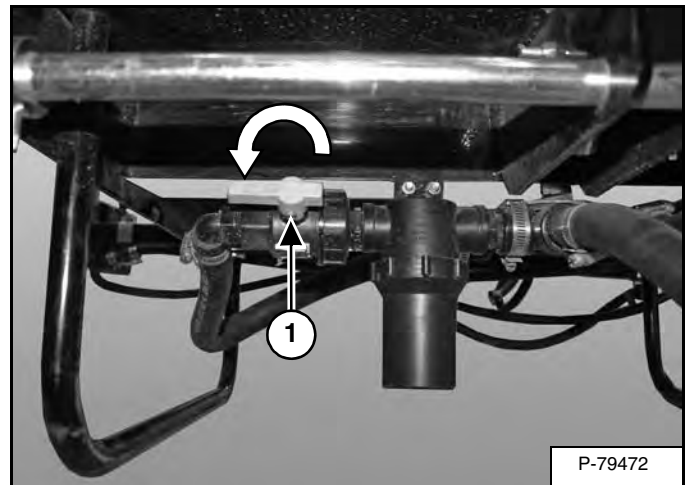

Before servicing or replacing the strainer, turn valve (Item 1) [Figure 10-20-1] to the close position to keep the water in the tank when the cup is removed.

NOTE: Product contained in the hoses will empty through the strainer housing when the cup is removed.

Figure 10-20-2

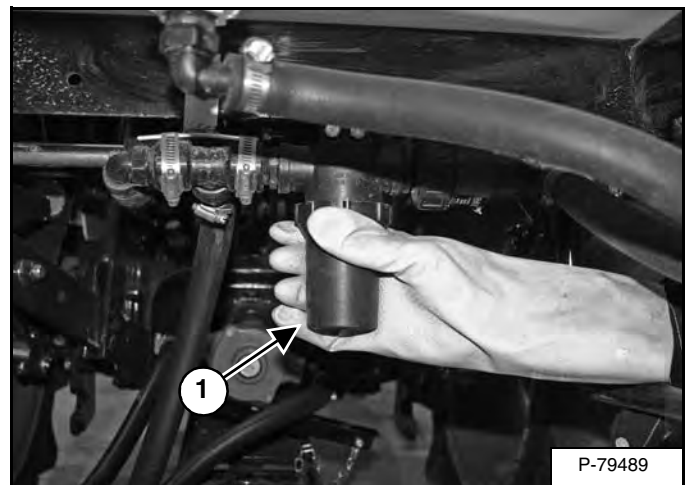

Remove the cup (Item 1) [Figure 10-20-2] and screen. Clean thoroughly and replace after everyday use.

NOTE: When reassembling the screen and cup on the housing, slide the screen in position prior to installing the cup. Use the same procedure when the O-ring seal is replaced.



Bobcat®

Dear

**Thanks very much for your visiting and
patience.**

Want to get more information,

Please click here, Go back to the page.

**After your payment, you will have instant access to
your download.**

The Download Link will also be sent to your e-mail.

You will get the complete manual

Have any questions

please write to me

admin@servicemanualperfect.com