

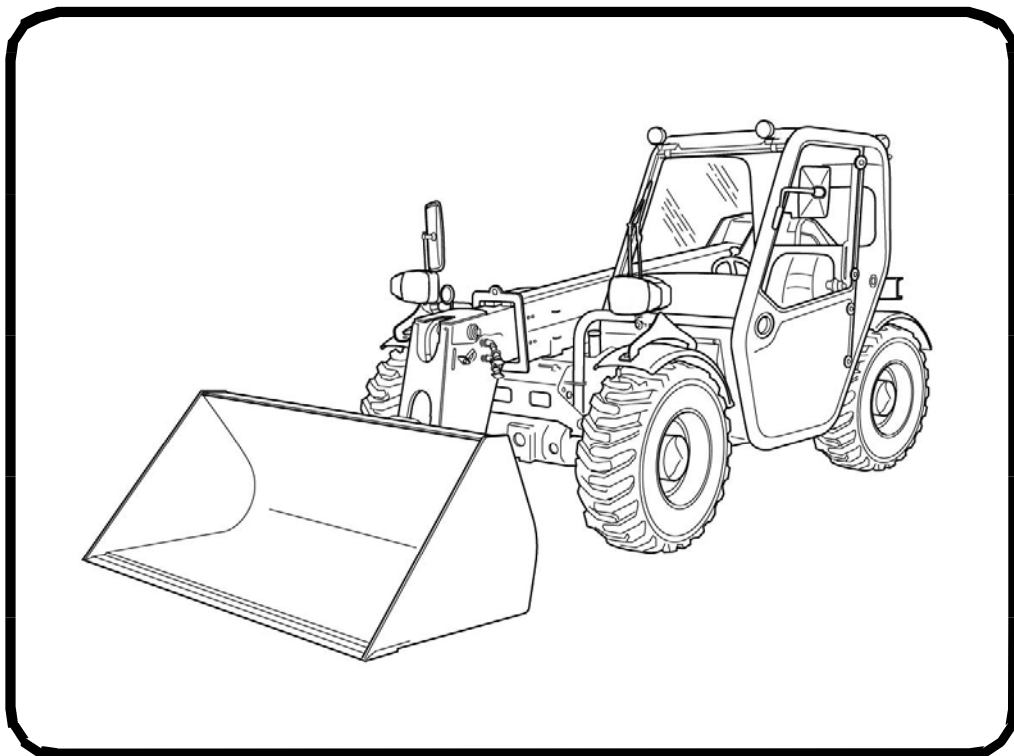

Service Manual

T2250 Telescopic Handler

S/N AC1911000 & Above



MAINTENANCE SAFETY



WARNING

Instructions are necessary before operating or servicing machine. Read and understand the Operation & Maintenance Manual, Operator's Handbook and signs (decals) on machine. Follow warnings and instructions in the manuals when making repairs, adjustments or servicing. Check for correct function after adjustments, repairs or service. Untrained operators and failure to follow instructions can cause injury or death.

W-2003-0807

CORRECT



P-90216

- ⚠ Never service the Bobcat Telescopic Handler without instructions.



Safety Alert Symbol: This symbol with a warning statement, means: "Warning, be alert! Your safety is involved!" Carefully read the message that follows.

CORRECT

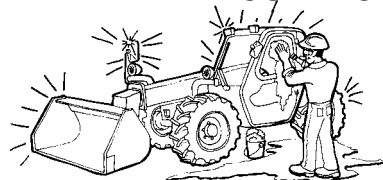

B-16082

- ⚠ Cleaning and maintenance are required daily.

WRONG

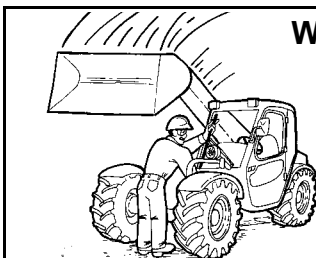

B-16080

- ⚠ Disconnecting or loosening any hydraulic tubeline, hose, fitting, component or a part failure can cause boom to drop. Do not go under boom when raised unless supported by an approved boom stop. Replace if damaged.

WRONG

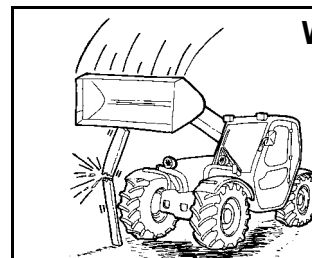

B-16079

- ⚠ Never work on Telescopic Handler with boom up unless boom is held by an approved boom stop. Replace if damaged.
- ⚠ Never modify equipment or add attachments not approved by Bobcat Company.

WRONG

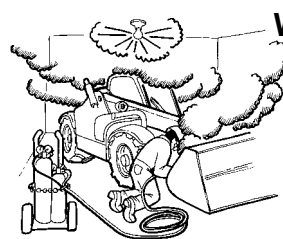

B-16081

- ⚠ Have good ventilation when welding or grinding painted parts.
- ⚠ Wear dust mask when grinding painted parts. Toxic dust and gas can be produced.
- ⚠ Avoid exhaust fume leaks which can kill without warning. Exhaust system must be tightly sealed.

WRONG

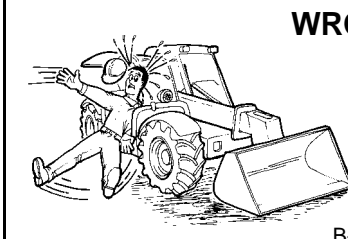

B-16078

- ⚠ Keep body, jewelry and clothing away from moving parts, electrical contact, hot parts and exhaust.
- ⚠ Wear eye protection to guard from battery acid, compressed springs, fluids under pressure and flying debris when engines are running or tools are used. Use eye protection approved for type of welding.

WRONG



B-6589

- ⚠ Lead-acid batteries produce flammable and explosive gases.
- ⚠ Keep arcs, sparks, flames and lighted tobacco away from batteries.
- ⚠ Batteries contain acid which burns eyes or skin on contact. Wear protective clothing. If acid contacts body, flush well with water. For eye contact flush well and get immediate medical attention.

Maintenance procedures which are given in the Operation & Maintenance Manual can be performed by the owner/operator without any specific technical training. Maintenance procedures which are **not** in the Operation & Maintenance Manual must be performed **ONLY BY QUALIFIED BOBCAT SERVICE PERSONNEL**. Always use **genuine Bobcat replacement parts**.



Bobcat®

CONTENTS

SAFETY AND MAINTENANCE	10-01
HYDRAULIC SYSTEM	20-01
HYDROSTATIC SYSTEM	30-01
DRIVE SYSTEM	40-01
MAIN FRAME	50-01
ELECTRICAL SYSTEM AND ANALYSIS	60-01
ENGINE SERVICE	70-01
HEATING, VENTILATION, AIR CONDITIONING	80-01
SPECIFICATIONS	SPEC-01
ALPHABETICAL INDEX	INDEX-01



Bobcat®

FOREWORD

FOREWORD	1-7
SAFETY INSTRUCTIONS	1-9
FIRE PREVENTION	1-10
Maintenance	1-10
Operation	1-10
Electrical	1-10
Hydraulic System	1-11
Fueling	1-11
Starting	1-11
Spark Arrestor Exhaust System	1-11
Welding And Grinding	1-11
Fire Extinguishers	1-11
SERIAL NUMBER LOCATION	1-12
VersaHANDLER Serial Number	1-12
Engine Serial Number	1-12
Other Serial Numbers	1-12
DELIVERY REPORT	1-13
BOBCAT VERSAHANDLER IDENTIFICATION	1-14







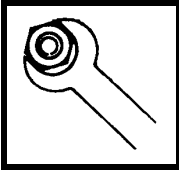
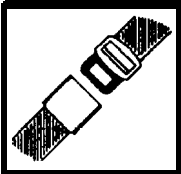

Bobcat®

FOREWORD

This manual is for the Bobcat telescopic handler mechanic. It provides necessary servicing and adjustment procedures for the Bobcat telescopic handler and its component parts and systems. Refer to the Operation & Maintenance Manual for operating instructions, starting procedure, daily checks, etc.

A general inspection of the following items must be made after the telescopic handler has had service or repair:

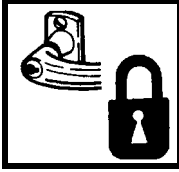
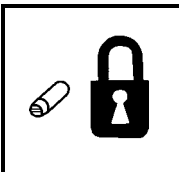
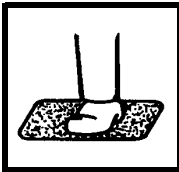
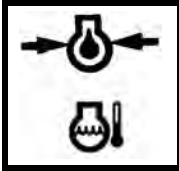
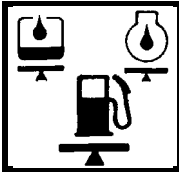
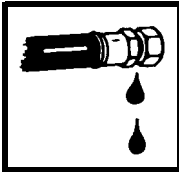
1. Check that ROPS/FOPS (including right side window) is in good condition and is not modified. 
2. Check that ROPS mounting hardware is tightened and is Bobcat approved. 
3. The seat belt must be correctly installed, functional and in good condition. 
4. Check boom stop, replace if damaged. 
5. Machine signs (decals) must be legible and in the correct location. 
6. Joystick control lever and foot pedals must return to neutral. 
7. Check for correct function of the work lights. 
8. The parking brake must function correctly. 
9. Enclosure door latches must open and close freely. 
10. Attachment locking pins must function correctly and be in good condition. Bob-Tach wedges and linkages (if equipped) must function correctly and be in good condition. 
11. Safety treads must be in good condition. 
12. Check for correct function of indicator lamps and gauges. 
13. Check hydraulic fluid level, engine oil level and fuel supply. 
14. Inspect for fuel, oil or hydraulic fluid leaks. 

15. Lubricate the telescopic handler.



16. Check the condition of the battery and cables.

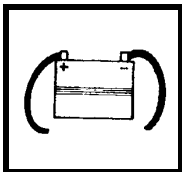

17. Inspect the air cleaner for damage or leaks. Check the condition of the element.

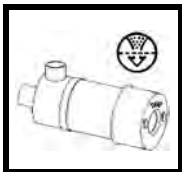

18. Check the electrical charging system.

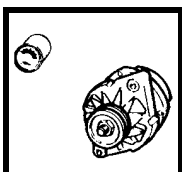

19. Check tires for wear and pressure. Use only approved tires.

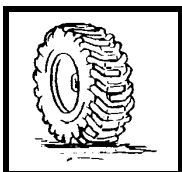

20. Inspect for loose or broken parts or connections.

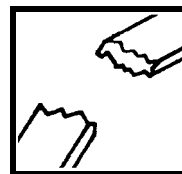

21. Check for any field modification not completed.



22. Operate the machine and check all functions.

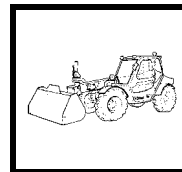

23. Check function or condition of all equipped options and accessories (examples: back-up alarm, fire extinguisher, rotating beacon, front stabilizers, etc.).



24. Recommend to the owner that all necessary corrections be made before the machine is returned to service.

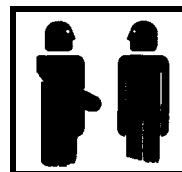

SAFETY INSTRUCTIONS



Safety Alert Symbol

This symbol with a warning statement means: "Warning, be alert! Your safety is involved!" Carefully read the message that follows.



WARNING

Instructions are necessary before operating or servicing machine. Read and understand the Operation & Maintenance Manual, Operator's Handbook and signs (decals) on machine. Follow warnings and instructions in the manuals when making repairs, adjustments or servicing. Check for correct function after adjustments, repairs or service. Untrained operators and failure to follow instructions can cause injury or death.

W-2003-0807

IMPORTANT

This notice identifies procedures which must be followed to avoid damage to the machine.

I-2019-0284



DANGER

The signal word DANGER on the machine and in the manuals indicates a hazardous situation which, if not avoided, will result in death or serious injury.

D-1002-1107



WARNING

The signal word WARNING on the machine and in the manuals indicates a potentially hazardous situation which, if not avoided, could result in death or serious injury.

W-2044-1107

The following publications provide information on the safe use and maintenance of the Bobcat machine and attachments:

- The Delivery Report is used to assure that complete instructions have been given to the new owner and that the machine is in safe operating condition.
- The Operation & Maintenance Manual delivered with the machine or attachment contains operating information as well as routine maintenance and service procedures. It is a part of the machine and can be stored in a container provided on the machine. Replacement Operation & Maintenance Manuals can be ordered from your Bobcat dealer.
- Machine signs (decals) instruct on the safe operation and care of your Bobcat machine or attachment. The signs and their locations are shown in the Operation & Maintenance Manual. Replacement signs are available from your Bobcat dealer.
- An Operator's Handbook fastened to the operator cab. It's brief instructions are convenient to the operator. The handbook is available from your dealer in an English edition or one of many other languages. See your Bobcat dealer for more information on translated versions.
- The AEM Safety Manual delivered with the machine gives general safety information.
- The Service Manual and Parts Manual are available from your dealer for use by mechanics to do shop-type service and repair work.
- The Telescopic Handler Operator Training Course is available through your local dealer or at www.training.bobcat.com or www.bobcat.com. This course is intended to provide rules and practices of correct operation of the Telescopic Handler.
- The Telescopic Handler Safety Video is available from your Bobcat dealer or at www.training.bobcat.com or www.bobcat.com.

The dealer and owner / operator review the recommended uses of the product when delivered. If the owner / operator will be using the machine for a different application(s) he or she must ask the dealer for recommendations on the new use.

SI VH EMEA-0409 SM

SAFETY INSTRUCTIONS (CONT'D)



Cutting or drilling concrete containing sand or rock containing quartz may result in exposure to silica dust. Use a respirator, water spray or other means to control dust.

FIRE PREVENTION



Maintenance

The machine and some attachments have components that are at high temperatures under normal operating conditions. The primary source of high temperatures is the engine and exhaust system. The electrical system, if damaged or incorrectly maintained, can be a source of arcs or sparks.

Flammable debris (leaves, straw, etc.) must be removed regularly. If flammable debris is allowed to accumulate, it can cause a fire hazard. Clean often to avoid this accumulation. Flammable debris in the engine compartment is a potential fire hazard.

The operator's area, engine compartment and engine cooling system must be inspected every day and cleaned if necessary to prevent fire hazards and overheating.

All fuels, most lubricants and some coolants mixtures are flammable. Flammable fluids that are leaking or spilled onto hot surfaces or onto electrical components can cause a fire.

Operation

Do not use the machine where exhaust, arcs, sparks or hot components can contact flammable material, explosive dust or gases.

Electrical



Check all electrical wiring and connections for damage. Keep the battery terminals clean and tight. Repair or replace any damaged part or wires that are loose or frayed.

Battery gas can explode and cause serious injury. Use the procedure in the Operation & Maintenance Manual for connecting the battery and for jump starting. Do not jump start or charge a frozen or damaged battery. Keep any open flames or sparks away from batteries. Do not smoke in battery charging area.

SI VH EMEA-0409 SM

FIRE PREVENTION (CONT'D)

Hydraulic System

Check hydraulic tubes, hoses and fittings for damage and leakage. Never use open flame or bare skin to check for leaks. Hydraulic tubes and hoses must be properly routed and have adequate support and secure clamps. Tighten or replace any parts that show leakage.

Always clean fluid spills. Do not use gasoline or diesel fuel for cleaning parts. Use commercial nonflammable solvents.

Fueling



Stop the engine and let it cool before adding fuel. No smoking! Do not refuel a machine near open flames or sparks. Fill the fuel tank outdoors.

Starting

Do not use ether or starting fluids on any engine that has glow plugs. These starting aids can cause explosion and injure you or bystanders.

Use the procedure in the Operation & Maintenance Manual for connecting the battery and for jump starting.

Spark Arrestor Exhaust System

The spark arrestor exhaust system is designed to control the emission of hot particles from the engine and exhaust system, but the muffler and the exhaust gases are still hot.

Check the spark arrestor exhaust system regularly to make sure it is maintained and working properly. Use the procedure in the Operation & Maintenance Manual for cleaning the spark arrestor muffler (if equipped).

Welding And Grinding

Always clean the machine and attachment, disconnect the battery, and disconnect the wiring from the Bobcat controllers before welding. Cover rubber hoses, battery and all other flammable parts. Keep a fire extinguisher near the machine when welding.

Have good ventilation when grinding or welding painted parts. Wear dust mask when grinding painted parts. Toxic dust or gas can be produced.

Dust generated from repairing nonmetallic parts such as hoods, fenders or covers can be flammable or explosive. Repair such components in a well ventilated area away from open flames or sparks.

Fire Extinguishers

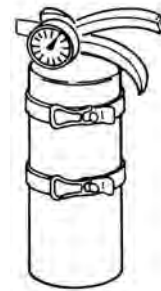

Know where fire extinguishers and first aid kits are located and how to use them. Inspect the fire extinguisher and service the fire extinguisher regularly. Obey the recommendations on the instructions plate.

SERIAL NUMBER LOCATION

Always use the serial number of the telescopic handler when requesting service information or when ordering parts.

Figure 1

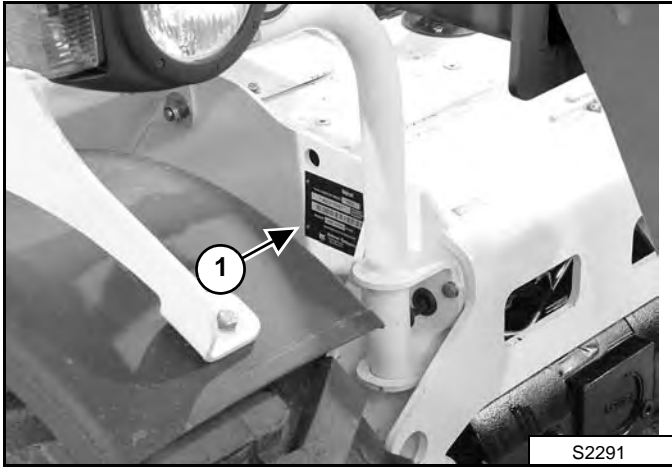

Telescopic Handler Serial Number

The telescopic handler serial number plate is located on the right side of the chassis in front [Figure 1].

Explanation of telescopic handler serial number:

XXXX XXXXX

Module 2. - Production Sequence (Series)

Module 1. - Model / Engine Combination

1. The four digit Model/Engine Combination Module number identifies the model number and engine combination.

2. The five digit Production Sequence Number identifies the order which the telescopic handler is produced.

Engine Serial Number

Figure 2



The engine serial number can be found on top of the valve cover (Item 1) [Figure 2]. Always use the full number when ordering replacement parts.

Other Serial Numbers

Other components may also have serial numbers and an identification plate. Always use these serial numbers when ordering parts.

DELIVERY REPORT

Figure 3

A diagram of a delivery report form. The form is titled "DELIVERY REPORT" and contains several sections. At the top right, there is a section for the dealer's name and address. Below this, there is a section for the owner's name and address. A prominent "WARNING" section is located on the left side of the form. The form is filled with horizontal lines representing text input fields. The form number B-16315 is located in the bottom right corner.

The delivery report must be completed by the dealer and signed by the owner or operator when the Bobcat telescopic handler is delivered. An explanation of the form must be given to the owner. Make sure it is complete [Figure 3].

BOBCAT TELESCOPIC HANDLER IDENTIFICATION

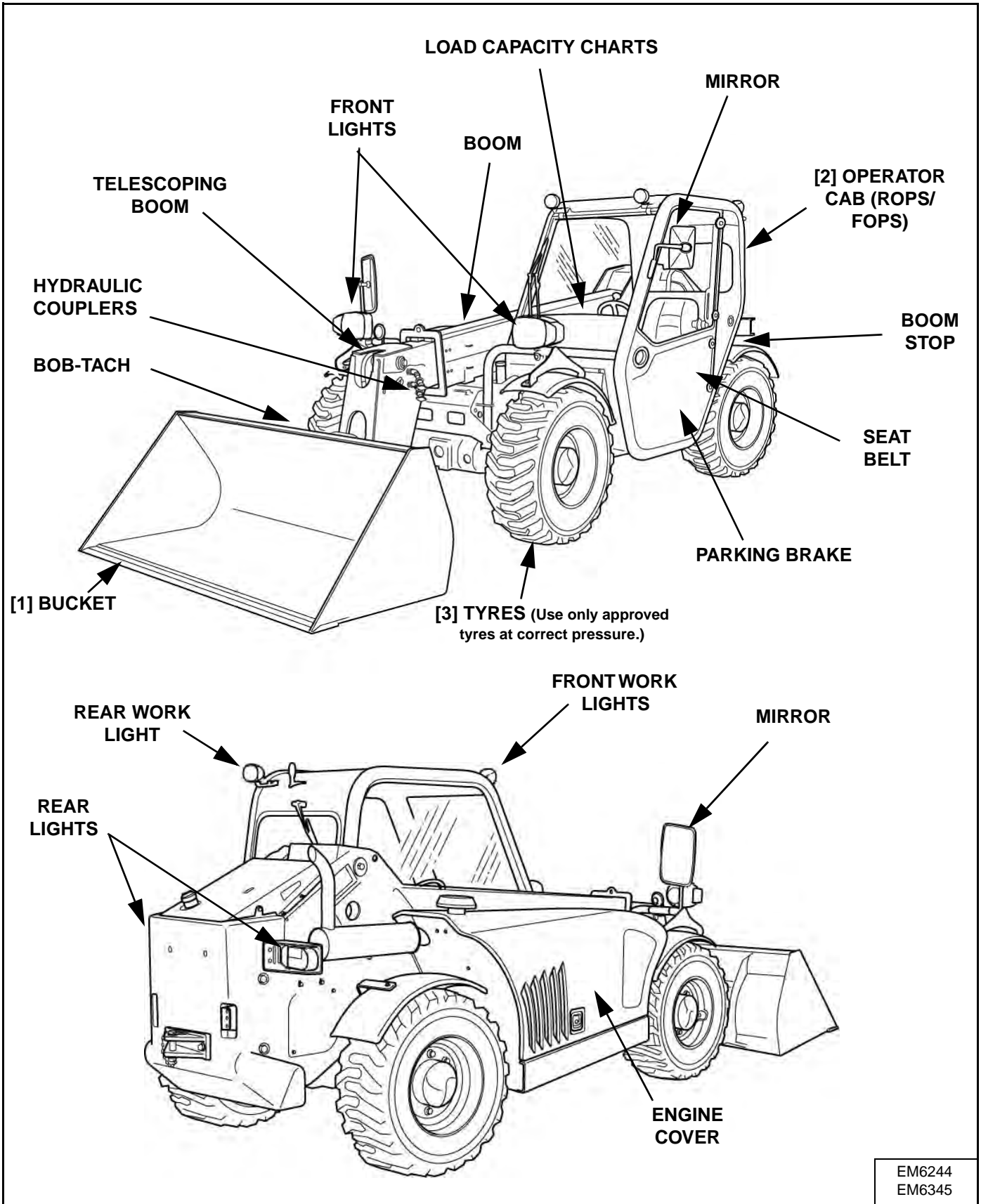



Bobcat®

SAFETY AND MAINTENANCE

LIFTING AND BLOCKING THE TELESCOPIC HANDLER	10-10-1
Procedure	10-10-1
OPERATOR CAB	10-20-1
Emergency Exit	10-20-1
Cab Door	10-20-2
Cab Door Window	10-20-2
TRANSPORTING THE TELESCOPIC HANDLER	10-30-1
Loading And Unloading	10-30-1
Fastening	10-30-1
TOWING THE TELESCOPIC HANDLER	10-40-1
Releasing The Brake Discs	10-40-1
Towing	10-40-2
Engaging The Brake Discs	10-40-2
SERVICE SCHEDULE	10-50-1
Chart	10-50-1
AIR CLEANER SERVICE	10-60-1
Replacing The Filter Element	10-60-1
ENGINE COOLING SYSTEM	10-70-1
Cleaning The Cooling System	10-70-1
Checking The Coolant Level	10-70-1
Replacing The Coolant	10-70-2
FUEL SYSTEM	10-80-1
Fuel Specifications	10-80-1
Filling The Fuel Tank	10-80-1
Fuel Filter	10-80-2
ENGINE LUBRICATION SYSTEM	10-90-1
Checking Engine Oil	10-90-1
Oil Chart	10-90-1
Replacing Oil And Filter	10-90-1
HYDRAULIC / HYDROSTATIC SYSTEM	10-100-1
Checking And Adding Fluid	10-100-1
Replacing The Hydraulic / Hydrostatic Filters	10-100-1
Replacing Hydraulic Fluid	10-100-2
AXLES (FRONT AND REAR)	10-110-1
Checking Oil Level (Planetary Carrier)	10-110-1
Draining Oil (Planetary Carrier)	10-110-1
Checking Oil Level (Rear Differential)	10-110-2
Draining Oil (Rear Differential)	10-110-2

Checking Oil Level (Front Differential)	10-110-3
Draining Oil (Front Differential)	10-110-3
LUBRICATION	10-120-1
Procedure	10-120-1
TIRE MAINTENANCE	10-130-1
Wheel Nuts	10-130-1
Tire Mounting	10-130-1
Tire Rotation	10-130-1
Tire Pressure	10-130-1
APPROVED BOOM STOP	10-150-1
Installing The Approved Boom Stop	10-150-1
Removing The Approved Boom Stop	10-150-1
ENGINE COVER	10-160-1
Opening And Closing The Engine Cover	10-160-1
REMOTE START	10-180-1
Connecting to the Telescopic Handler	10-180-1
Remote Start Procedure (For Tools MEL1563 and MEL1565)	10-180-3
Remote Start Procedure (For Tool Kit P/N 6689779)	10-180-4
ALTERNATOR BELT	10-190-1
Belt Adjustment	10-190-1
Belt Replacement	10-190-1

Dear

**Thanks very much for your visiting and
patience.**

Want to get more information,

Please click here, Go back to the page.

**After your payment, you will have instant access to
your download.**

The Download Link will also be sent to your e-mail.

You will get the complete manual

Have any questions

please write to me

admin@servicemanualperfect.com