

S130



Bobcat®

Service Manual

S/N 524611001 & Above
S/N 524711001 & Above

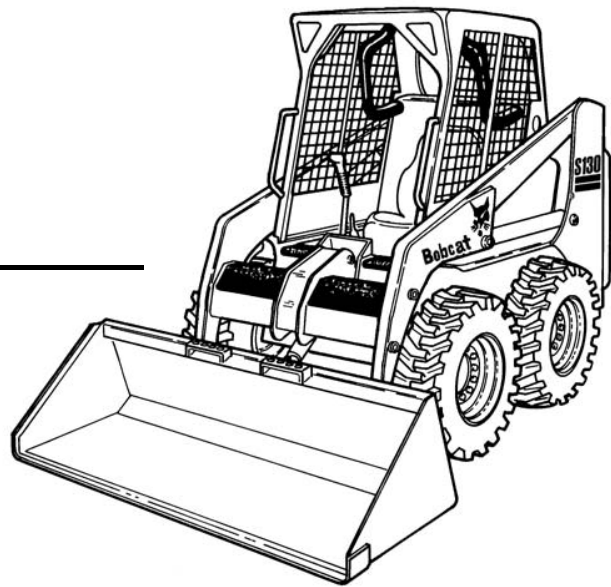

EQUIPPED WITH
BOBCAT INTERLOCK
CONTROL SYSTEM (BICS™)

6902680 (3-06)

1 of 636



Printed in U.S.A.

© Bobcat Company 2006

MAINTENANCE SAFETY



WARNING

Instructions are necessary before operating or servicing machine. Read and understand the Operation & Maintenance Manual, Operator's Handbook and signs (decals) on machine. Follow warnings and instructions in the manuals when making repairs, adjustments or servicing. Check for correct function after adjustments, repairs or service. Untrained operators and failure to follow instructions can cause injury or death.

W-2003-0903



Safety Alert Symbol: This symbol with a warning statement, means: "Warning, be alert! Your safety is involved!" Carefully read the message that follows.

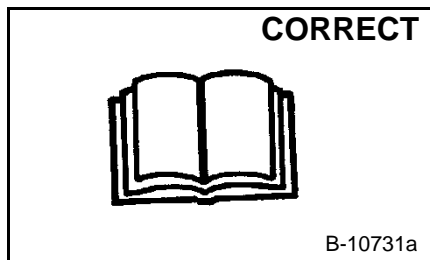

Never service the Bobcat Skid-Steer Loader without instructions.

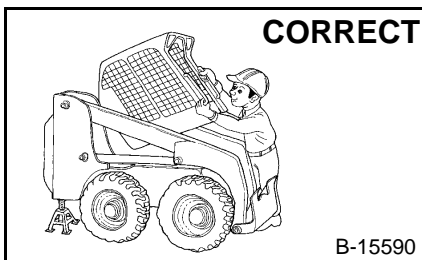

Use the correct procedure to lift or lower operator cab.

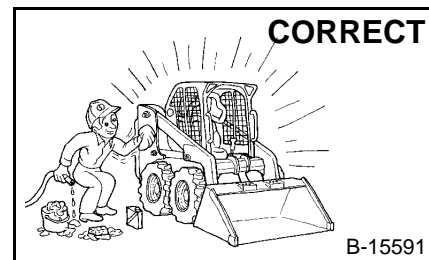

Cleaning and maintenance are required daily.

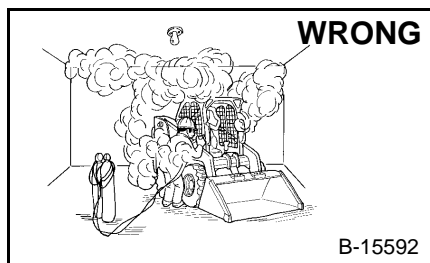

- Have good ventilation when welding or grinding painted parts.
- Wear dust mask when grinding painted parts. Toxic dust and gas can be produced.
- Avoid exhaust fume leaks which can kill without warning. Exhaust system must be tightly sealed.

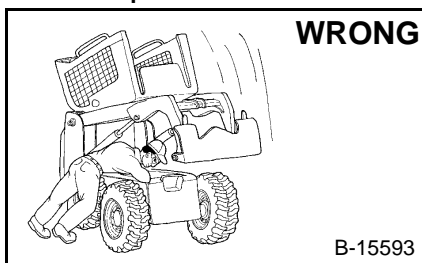

- Disconnecting or loosening any hydraulic tubeline, hose, fitting, component or a part failure can cause lift arms to drop. Do not go under lift arms when raised unless supported by an approved lift arm support device. Replace it if damaged.

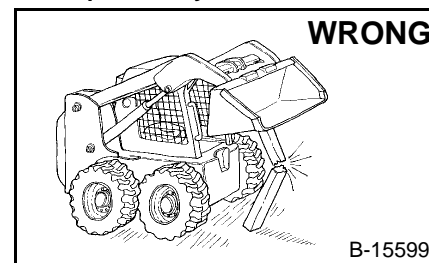

- Never work on loader with lift arms up unless lift arms are held by an approved lift arm support device. Replace if damaged.
- Never modify equipment or add attachments not approved by Bobcat Company.

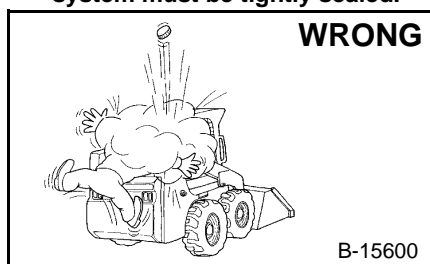

- Stop, cool and clean engine of flammable materials before checking fluids.
- Never service or adjust loader with the engine running unless instructed to do so in the manual.
- Avoid contact with leaking hydraulic fluid or diesel fuel under pressure. It can penetrate the skin or eyes.
- Never fill fuel tank with engine running, while smoking or when near open flame.

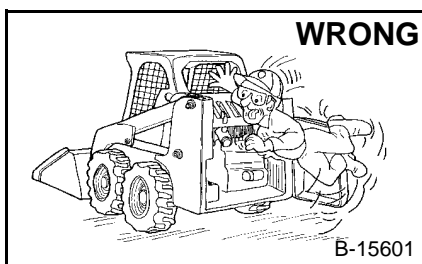

- Keep body, jewelry and clothing away from moving parts, electrical contact, hot parts and exhaust.
- Wear eye protection to guard from battery acid, compressed springs, fluids under pressure and flying debris when engines are running or tools are used. Use eye protection approved for type of welding.
- Keep rear door closed except for service. Close and latch door before operating the loader.

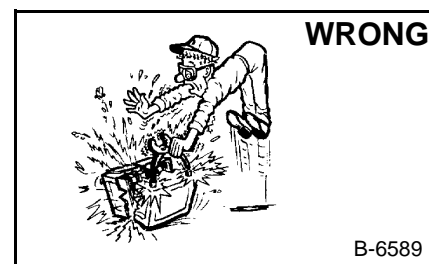

- Lead-acid batteries produce flammable and explosive gases.
- Keep arcs, sparks, flames and lighted tobacco away from batteries.
- Batteries contain acid which burns eyes or skin on contact. Wear protective clothing. If acid contacts body, flush well with water. For eye contact flush well and get immediate medical attention.

Maintenance procedures which are given in the Operation & Maintenance Manual can be performed by the owner/operator without any specific technical training. Maintenance procedures which are **not** in the Operation & Maintenance Manual must be performed **ONLY BY QUALIFIED BOBCAT SERVICE PERSONNEL**. Always use genuine Bobcat replacement parts. The Service Safety Training Course is available from your Bobcat dealer.



Bobcat®

ALPHABETICAL INDEX

ADVANCED CONTROL SYSTEM (ACS)		FAN GEARBOX.....	10-01
ADVANCE HAND CONTROL.....	60-01	FINAL DRIVE TRANSMISSION (CHAINCASE).....	10-01
ADVANCED CONTROL SYSTEM (ACS)		FLYWHEEL AND HOUSING.....	70-01
SELECTRABLE HAND/FOOT CONTROL.....	60-01	FRONT AUXILIARY HYDRAULIC	
ADVANCED HAND CONTROL (AHC) SYSTEM....	60-01	COUPLER BLOCK.....	20-01
ADVANCED HAND CONTROL (AHC)		FRONT AUXILIARY PRESSURE	
SYSTEM (W/PUSH BUTTON FLOAT).....	60-01	RELIEF BLOCK.....	20-01
AIR CLEANER SERVICE.....	10-01, 70-01	FUEL SYSTEM.....	10-01
		FUEL TANK.....	50-01
BASIC TROUBLESHOOTING.....	80-01		
BATTERY.....	60-01	HEATER UNIT.....	80-01
BICS™ SYSTEM.....	60-01	HEATER COIL.....	80-01
BOBCAT CONTROLLER.....	60-01	HEATER FAN.....	80-01
BOBCAT INTERLOCK		HEATER VALVE.....	80-01
CONTROL SYSTEM (BICS™).....	60-01	HYDRAULIC CONNECTION SPECS.....	SPEC-01
BOB-TACH.....	10-01, 50-01	HYDRAULIC CONTROL VALVE (ADVANCED	
BRAKE.....	40-01	CONTROL SYSTEM) (ACS).....	20-01
BUCKET POSITION VALVE.....	20-01	HYDRAULIC CONTROL VALVE	
		(FOOT CONTROL).....	20-01
CHAINCASE.....	40-01	HYDRAULIC FLUID RESERVOIR.....	20-01
CHARGE PRESSURE.....	30-01	HYDRAULIC/HYDROSTATIC FILTER.....	20-01
COMPONENTS.....	80-01	HYDRAULIC FLUID SPECIFICATIONS.....	SPEC-01
CONTROL HANDLE.....	50-01	HYDRAULIC/HYDROSTATIC SYSTEM.....	10-01
CONTROL HANDLE		HYDRAULIC SYSTEM INFORMATION.....	20-01
(ADVANCE HAND CONTROL) (AHC).....	50-01	HYDRAULIC PUMP.....	20-01
CONTROL HANDLE (ADVANCED CONTROL SYSTEM)		HYDROSTATIC MOTOR.....	30-01
(ACS) ADVANCED HAND CONTROL.....	50-01	HYDROSTATIC PUMP.....	30-01
CONTROL PANEL.....	50-01	HYDROSTATIC SYSTEM INFORMATION.....	30-01
CONTROL PEDALS.....	50-01		
CONTROL PEDALS (ACS).....	50-01	INSTRUMENT PANEL.....	60-01
CONVERSIONS.....	SPEC-01		
COOLING FAN.....	70-01	LIFT ARM.....	50-01
CYLINDER (LIFT).....	20-01	LIFT ARM BY-PASS CONTROL VALVE.....	20-01
CYLINDER (POWER BOB-TACH).....	20-01	LIFT ARM SUPPORT DEVICE.....	10-01
CYLINDER (TILT).....	20-01	LIFTING AND BLOCKING THE LOADER.....	10-01
		LIGHTS.....	60-01
DIAGNOSTICS.....	60-01	LOADER SPECIFICATIONS.....	SPEC-01
DRIVE BELT.....	30-01	LUBRICATION OF THE BOBCAT LOADER.....	10-01
DRIVE COMPONENTS.....	40-01		
		MAIN RELIEF VALVE.....	20-01
ELECTRICAL/HYD. CONTROLS REFERENCE....	60-01	MUFFLER.....	70-01
ELECTRICAL SYSTEM INFORMATION.....	60-01		
ENGINE.....	70-01	OIL COOLER.....	30-01
ENGINE COMPONENTS AND TESTING.....	70-01	OPERATOR CAB.....	10-01, 50-01
ENGINE COOLING SYSTEM.....	10-01	OPERATOR SEAT.....	50-01
ENGINE LUBRICATION SYSTEM.....	10-01	OPERATOR SEAT (SUSPENSION).....	50-01
ENGINE SPECIFICATIONS.....	SPEC-		
ENGINE SPEED CONTROL.....	70-01	POWER BOB-TACH.....	50-01
		POWER BOB-TACH BLOCK.....	50-01

Continued On Next Page

ALPHABETICAL INDEX (CONT'D)

RADIATOR.....	70-
REAR DOOR	50-01
REAR GRILL	50-01
RECONDITIONING THE ENGINE	70-01
REGULAR MAINTENANCE	80-01
REMOTE START.....	10-01
RPM SENSOR.....	70-01
SEAT BAR.....	50-01
SEAT BAR SENSOR.....	60-01
SELECT VALVE	20-
SERVICE SCHEDULE.....	10-01
SPARK ARRESTOR MUFFLER.....	10-01
STARTER	60-01
SYSTEM TROUBLESHOOTING CHART	80-01
TIRE MAINTENANCE.....	10-01
TORQUE SPECIFICATIONS FOR BOLTS	SPEC-01
TOWING THE LOADER	10-01
TRACTION LOCK.....	60-01
TRANSPORTING THE LOADER	10-01
TROUBLESHOOTING.....	70-01

CONTENTS

FOREWORD.....	II
SAFETY INSTRUCTIONS	V
SERIAL NUMBER LOCATIONS	IX
DELIVERY REPORT.....	X
LOADER IDENTIFICATION	XI
SAFETY AND MAINTENANCE.....	10-01
HYDRAULIC SYSTEM	20-01
HYDROSTATIC SYSTEM.....	30-01
DRIVE SYSTEM	40-01
MAIN FRAME	50-01
ELECTRICAL SYSTEM & ANALYSIS	60-01
ENGINE SERVICE	70-01
HEATER	80-01
SPECIFICATIONS	SPEC-01

**SAFETY &
MAINTENANCE**

**HYDRAULIC
SYSTEM**

**HYDROSTATIC
SYSTEM**

**DRIVE
SYSTEM**

MAIN FRAME

**ELECTRICAL
SYSTEM &
ANALYSIS**

**ENGINE
SERVICE**

HEATER

SPECIFICATIONS

FOREWORD

This manual is for the Bobcat loader mechanic. It provides necessary servicing and adjustment procedures for the Bobcat loader and its component parts and systems. Refer to the Operation & Maintenance Manual for operating instructions, starting procedure, daily checks, etc.

A general inspection of the following items must be made after the loader has had service or repair:

1. Check that the ROPS/FOPS (Including side screens) is in good condition and is not modified.

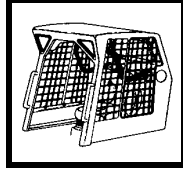

2. Check that ROPS mounting hardware is tightened and is Bobcat approved.



3. The seat belt must be correctly installed, functional and in good condition.

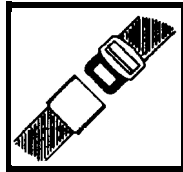

4. The seat bar must be correctly adjusted, clean and lubricated.

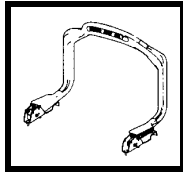

5. Check lift arm support device, replace if damaged.

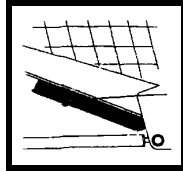

6. Machine signs must be legible and in the correct location.



7. Steering levers and foot pedals must return to neutral.

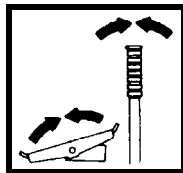

8. Check for correct function of the work lights



9. The parking brake must function correctly.



10. Enclosure door latches must open and close freely.

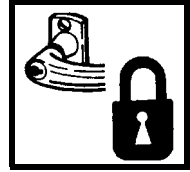

11. Bob-Tach wedges and linkages must function correctly and be in good condition.

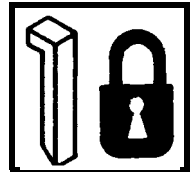

12. Safety treads must be in good condition.

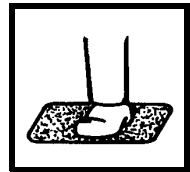

13. Check for correct function of indicator lamps (Optional on some models).

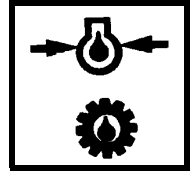

14. Check hydraulic fluid level, engine oil level and fuel supply.

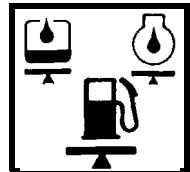

15. Inspect for fuel, oil or hydraulic fluid leaks.

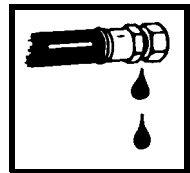

16. Lubricate the loader.

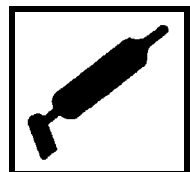

17. Check the condition of the battery and cables.



22. Operate the loader and check all functions.



18. Inspect the air cleaner for damage or leaks. Check the condition of the element.

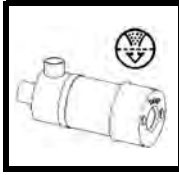

23. Check for any field modification not completed.



19. Check the electrical charging system.

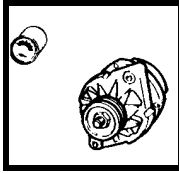

24. Check for correct function of the Bobcat Interlock Control System (BICST™) before the machine is returned to the customer.

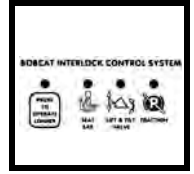

20. Check tires for wear and pressure.

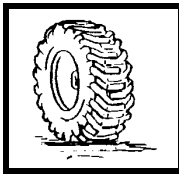

Recommend to the owner that all necessary corrections be made before the machine is returned to service.

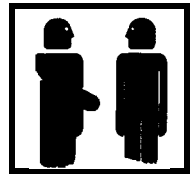

21. Inspect for loose or broken parts or connections.

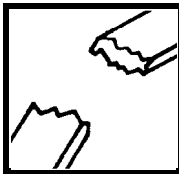

**CALIFORNIA
PROPOSITION 65 WARNING**

Diesel engine exhaust and some of its constituents are known to the State of California to cause cancer, birth defects and other reproductive harm.



Bobcat®

SAFETY INSTRUCTIONS



Safety Alert Symbol

This symbol with a warning statement means:
“Warning, be alert! Your safety is involved!”
Carefully read the message that follows.



WARNING

Instructions are necessary before operating or servicing machine. Read and understand the Operation & Maintenance Manual, Operator's Handbook and signs (decals) on machine. Follow warnings and instructions in the manuals when making repairs, adjustments or servicing. Check for correct function after adjustments, repairs or service. Untrained operators and failure to follow instructions can cause injury or death.

W-2003-0903



WARNING

Warnings on the machine and in the manuals are for your safety. Failure to obey warnings can cause injury or death.

W-2044-1285

IMPORTANT

This notice identifies procedures which must be followed to avoid damage to the machine.

I-2019-0284

The following publications provide information on the safe use and maintenance of the Bobcat machine and attachments:

- The Delivery Report is used to assure that complete instructions have been given to the new owner and that the machine is in safe operating condition.
- The Operation & Maintenance Manual delivered with the machine or attachment contains operating information as well as routine maintenance and service procedures. It is a part of the machine and can be stored in a container provided on the machine. Replacement Operation & Maintenance Manuals can be ordered from your Bobcat dealer.
- Machine signs (decals) instruct on the safe operation and care of your Bobcat machine or attachment. The signs and their locations are shown in the Operation & Maintenance Manual. Replacement signs are available from your Bobcat dealer.
- An Operator's Handbook fastened to the operator cab. It's brief instructions are convenient to the operator. The handbook is available from your dealer in an English edition or one of many other languages. See your Bobcat dealer for more information on translated versions.
- The AEM Safety Manual delivered with the machine gives general safety information.
- The Service Manual and Parts Manual are available from your dealer for use by mechanics to do shop-type service and repair work.
- The Skid-Steer Loader Operator Training Course is available through your local dealer or at www.training.bobcat.com or www.bobcat.com. This course is intended to provide rules and practices of correct operation of the Skid-Steer Loader. The course is available in English and Spanish versions.
- Service Safety Training Courses are available from your Bobcat dealer or at www.training.bobcat.com or www.bobcat.com. They provide information for safe and correct service procedures.
- The Skid-Steer Loader Safety Video is available from your Bobcat dealer or at www.training.bobcat.com or www.bobcat.com.

SI SSL-0206 SM

SAFETY INSTRUCTIONS (CONT'D)

The dealer and owner/operator review the recommended uses of the product when delivered. If the owner/operator will be using the machine for a different application(s) he or she must ask the dealer for recommendations on the new use.



Call Before You Dig

1-888-258-0808

When you call, you will be directed to a location in your state/city for information about buried lines (telephone, cable TV, water, sewer, gas, etc.)

SAFETY INSTRUCTIONS (CONT'D)

Fire Prevention

The machine and attachments have components that are at high temperature under normal operating conditions. The primary source of high temperatures is the engine and exhaust system. The electrical system, if damaged or incorrectly maintained, can be a source of arcs or sparks.

Flammable debris (leaves, straw, etc.) must be removed regularly. If flammable debris is allowed to accumulate, it will increase fire hazard. Clean often to avoid this accumulation. Flammable debris in the engine compartment is a potential hazard.

The spark arrestor muffler is designed to control the emission of hot particles from the engine and exhaust system, but the muffler and the exhaust gases are still hot.

- Do not use the machine where exhaust, arcs, sparks or hot components can contact flammable material, explosive dust or gases.
- The operator cab, engine compartment, and engine cooling system must be inspected every day and cleaned if necessary to prevent fire hazard and overheating.
- Check all electrical wiring and connections for damage. Keep the battery terminals clean and tight. Repair or replace any damaged part.
- Check fuel and hydraulic tubes, hoses and fittings for damage and leakage. Never use open flame or bare skin to check for leaks. Tighten or replace any parts that show leakage. Always clean fluid spills. Do not use gasoline or diesel fuel for cleaning parts. Use commercial nonflammable solvents.
- Do not use ether or starting fluids on any engine which has glow plugs. These starting aids can cause explosion and injure you or bystanders.
- Always clean the machine, disconnect the battery, and disconnect the wiring from the controllers before welding. Cover rubber hoses, battery and all other flammable parts. Keep a fire extinguisher near the machine when welding. Have good ventilation when grinding or welding painted parts. Wear a dust mask when grinding painted parts. Toxic dust or gas can be produced.
- Stop the engine and let it cool before adding fuel. **NO SMOKING!**

- Use the procedure in the Operation & Maintenance Manual for connecting the battery and for jump starting.
- Use the procedure in the Operation & Maintenance Manual for cleaning the spark arrestor muffler (if equipped).

Figure 1

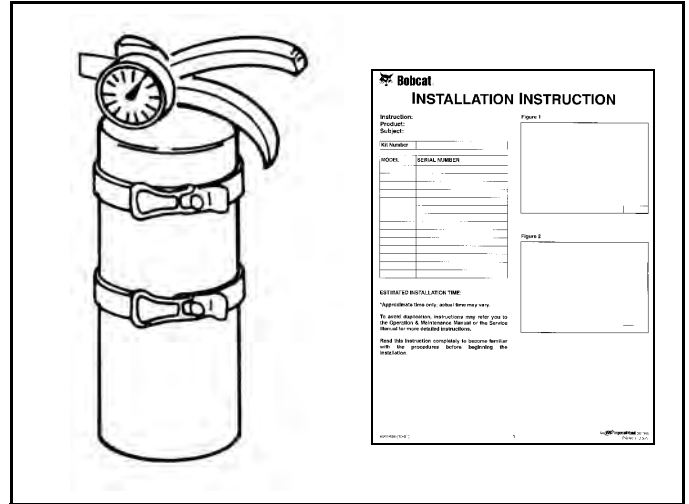

- Know where fire extinguishers and first aid kits are located and how to use them. Fire extinguishers are available from your Bobcat dealer **[Figure 1]**.



Bobcat®

SERIAL NUMBER LOCATIONS

Always use the serial number of the loader when requesting service information or when ordering parts. Early or later models (identification made by serial number) may use different parts, or it may be necessary to use a different procedure in doing a specific service operation.

Loader Serial Number

Figure 2

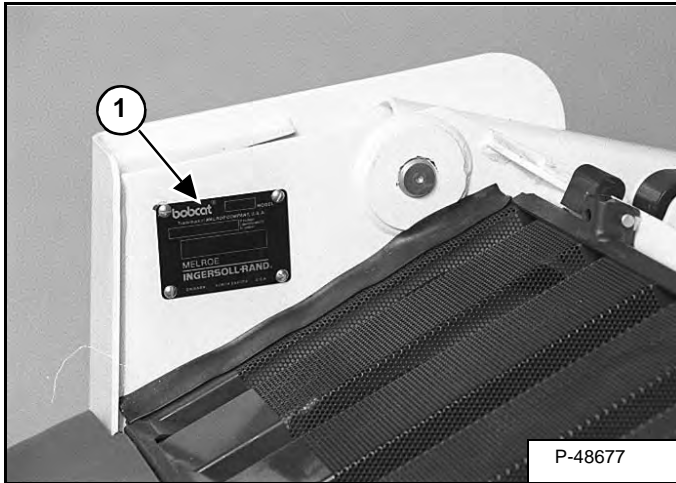

The loader serial number plate is located on the outside of the loader frame [Figure 2].

Explanation of loader Serial Number:

XXXX	XXXXX
Model 1.-Model/ Engine Combination	Model 2.-Production Sequence (Series)

1. The four digit Model/Engine Combination Module number identifies the model number and engine combination.
2. The five digit Production Sequence Number identifies the order which the loader is produced.

Engine Serial Number

Figure 3

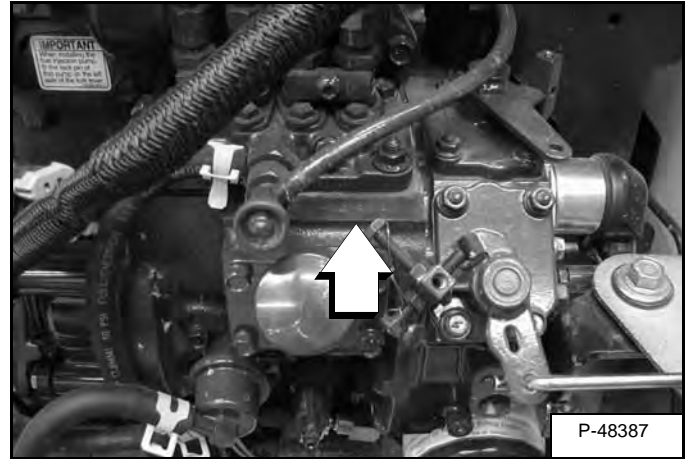

The engine serial number is in the location shown [Figure 3].

DELIVERY REPORT

Figure 4

The diagram shows a form layout for a 'DELIVERY REPORT'. The form is enclosed in a rectangular border. At the top right, there is a header box labeled 'DELIVERY REPORT'. Below this, the form is divided into two main columns. The left column contains a section with a black header labeled 'WARNING' and several lines of text below it. The right column contains several lines of text. At the bottom of the form, there is a small box containing the text 'B-16315'.

The Delivery Report must be filled out by the dealer and signed by the owner or operator when the Bobcat loader is delivered. An explanation of the form must be given to the owner. Make sure it is filled out completely **[Figure 4]**.

LOADER IDENTIFICATION

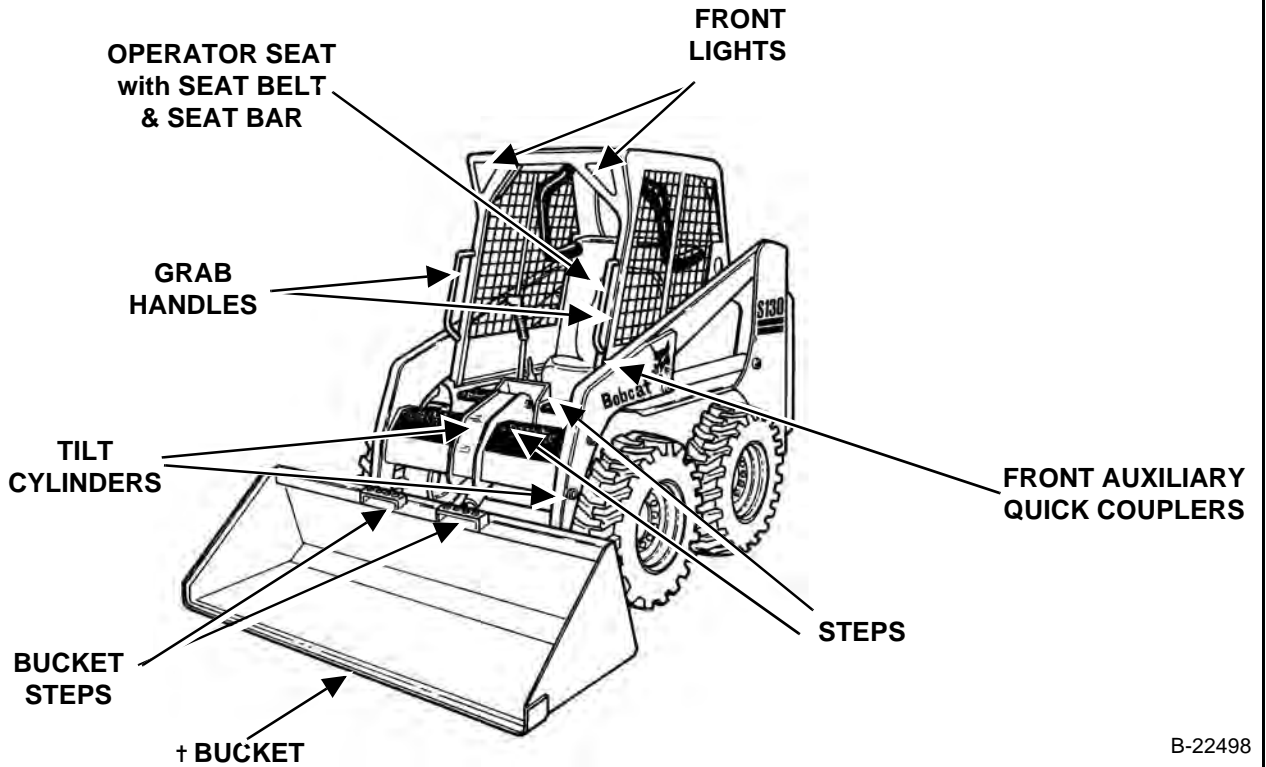

B-22498

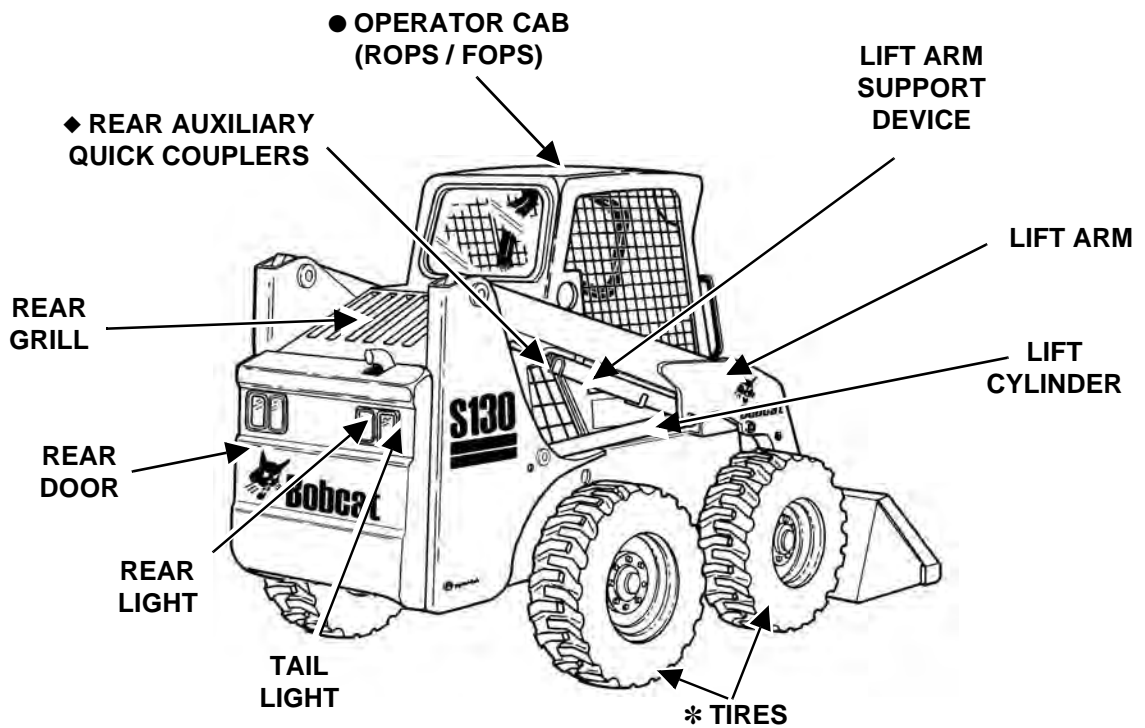

B-22499

◆ Optional or Field Accessory (Not Standard Equipment)

* TIRES - Tires shown may not be standard. The machine is factory equipped with standard tires. Other tires are available.

† Bucket - Several different buckets and other attachments are available for this machine.

● ROPS, FOPS - Roll Over Protective Structure, per SAE J1040 and ISO 3471, and Falling Object Protective Structure per ISO 3449, Level I. Level II is available.



Bobcat®

Dear

**Thanks very much for your visiting and
patience.**

Want to get more information,

Please click here, Go back to the page.

**After your payment, you will have instant access to
your download.**

The Download Link will also be sent to your e-mail.

You will get the complete manual

Have any questions

please write to me

admin@servicemanualperfect.com