



Bobcat®

Service Manual

**S/N 523611001 & Above
S/N 523711001 & Above**

Mini Track Loader

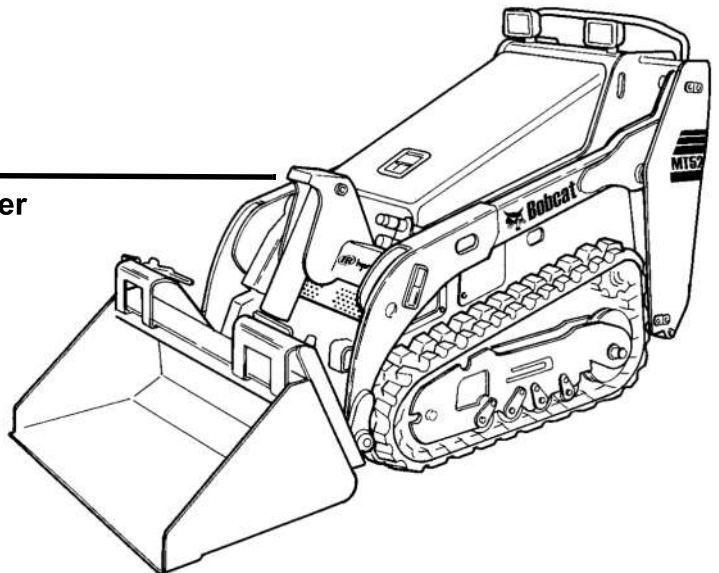

MAINTENANCE SAFETY



WARNING

Instructions are necessary before operating or servicing machine. Read and understand the Operation & Maintenance Manual, Operator's Handbook and signs (decals) on machine. Follow warnings and instructions in the manuals when making repairs, adjustments or servicing. Check for correct function after adjustments, repairs or service. Untrained operators and failure to follow instructions can cause injury or death.

W-2003-0903

CORRECT

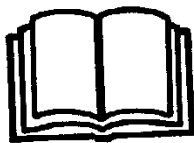

B-10731a

- ⚠ Never service the Bobcat Mini Track Loader without instructions.



Safety Alert Symbol: This symbol with a warning statement, means: "Warning, be alert! Your safety is involved!" Carefully read the message that follows.

WRONG



B-23041

- ⚠ Have good ventilation when welding or grinding painted parts.
- ⚠ Wear dust mask when grinding painted parts. Toxic dust and gas can be produced.
- ⚠ Avoid exhaust fume leaks which can kill without warning. Exhaust system must be tightly sealed.

WRONG

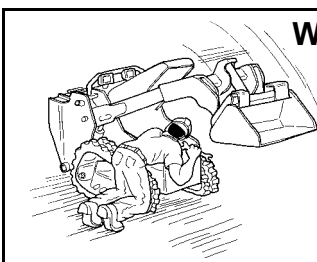

B-23035

- ⚠ Disconnecting or loosening any hydraulic tubeline, hose, fitting, component or a part failure can cause lift arms to drop. Do not go under lift arms when raised unless supported by an approved lift arm support device. Replace it if damaged.

WRONG

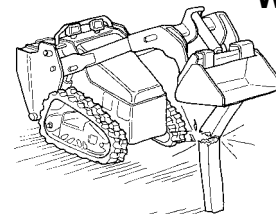

B-23036

- ⚠ Never work on loader with lift arms up unless lift arms are held by an approved lift arm support device. Replace if damaged.
- ⚠ Never modify equipment or add attachments not approved by Bobcat Company.

WRONG

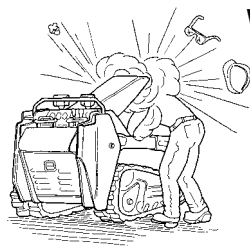

B-23039

- ⚠ Stop, cool and clean engine of flammable materials before checking fluids.
- ⚠ Never service or adjust loader with the engine running unless instructed to do so in the manual.
- ⚠ Avoid contact with leaking hydraulic fluid or diesel fuel under pressure. It can penetrate the skin or eyes.
- ⚠ Never fill fuel tank with engine running, while smoking or when near open flame.

WRONG

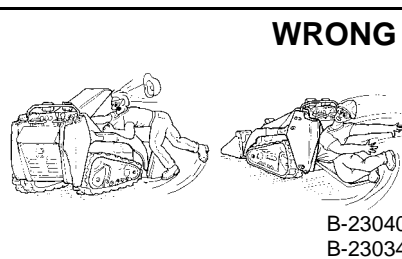

B-23040
B-23034

- ⚠ Keep body, jewelry and clothing away from moving parts, electrical contact, hot parts and exhaust.
- ⚠ Wear eye protection to guard from battery acid, compressed springs, fluids under pressure and flying debris when engines are running or tools are used. Use eye protection approved for type of welding.
- ⚠ Keep rear door closed except for service. Close and latch door before operating the loader.

WRONG



B-6589

- ⚠ Lead-acid batteries produce flammable and explosive gases.
- ⚠ Keep arcs, sparks, flames and lighted tobacco away from batteries.
- ⚠ Batteries contain acid which burns eyes or skin on contact. Wear protective clothing. If acid contacts body, flush well with water. For eye contact flush well and get immediate medical attention.

Maintenance procedures which are given in the Operation & Maintenance Manual can be performed by the owner/operator without any specific technical training. Maintenance procedures which are **not** in the Operation & Maintenance Manual must be performed **ONLY BY QUALIFIED BOBCAT SERVICE PERSONNEL**. Always use genuine Bobcat replacement parts. The Service Safety Training Course is available from your Bobcat dealer.



Bobcat®

ALPHABETICAL INDEX

AIR CLEANER	70-01	LOADER SPECIFICATIONS (MT52).....	SPEC-01
AIR CLEANER SERVICE	10-01	LIFT LOCK VALVE	20-01
ALTERNATOR	60-01	LIFT ARM	50-01
		LIFT ARM SUPPORT DEVICE.....	10-01
BATTERY	60-01	LIFTING AND BLOCKING THE LOADER.....	10-01
BOB-TACH.....	10-01, 50-01	LUBRICATION OF THE BOBCAT LOADER	10-01
BOTTOM ACCESS PANEL	50-01		
		MAIN RELIEF VALVE	20-01
CONTROLS	10-01	MUFFLER.....	70-01
CYLINDER (LIFT)	20-01		
CYLINDER (TILT)	20-01	NEUTRAL START SENSOR	60-01
DRIVE BELT	30-01	PARKING BRAKE.....	40-01
DRIVE COMPONENTS	40-01	PORT RELIEF VALVES.....	20-01
DRIVE MOTOR.....	30-01		
		RADIATOR	70-01
ELECTRICAL ATTACHMENT CONTROL REF.	60-01	RECONDITIONING THE ENGINE	70-01
ELECTRICAL SYSTEM	10-01	REVERSE STOP PANEL	50-01
ELECTRICAL SYSTEM INFORMATION	60-01	RIDE-ON PLATFORM	50-01
ENGINE	70-01		
ENGINE COMPONENTS AND TESTING	70-01	SERVICE SCHEDULE	10-01
ENGINE COOLING SYSTEM.....	10-01	SPARK ARRESTOR MUFFLER.....	10-01
ENGINE INFORMATION AND TESTING	70-01	STARTER	60-01
ENGINE LUBRICATION SYSTEM.....	10-01		
ENGINE MOUNTING BRACKET	70-01	TAILGATE.....	50-01
ENGINE SPECIFICATIONS.....	SPEC-01	TILT LOCK VALVE.....	20-01
ENGINE SPEED CONTROL	70-01	TORQUE SPECIFICATIONS FOR BOLTS	SPEC-01
		TOWING THE LOADER	10-01
FLYWHEEL.....	70-01	TRANSPORTING THE BOBCAT LOADER.....	10-01
FUEL SYSTEM	10-01		
FUEL TANK.....	50-01		
GRAB BAR	50-01		
HOOD	50-01		
HYDRAULIC CONNECTION SPECS.....	SPEC-01		
HYDRAULIC CONTROL VALVE.....	20-01		
HYDRAULIC FILTER	20-01		
HYDRAULIC FLUID RESERVOIR.....	20-01		
HYDRAULIC FLUID SPECIFICATIONS	SPEC-01		
HYD. GEAR PUMP MOUNTING BRACKET	70-01		
HYDRAULIC OIL COOLER	20-01		
HYDRAULIC PUMP.....	20-01		
HYDRAULIC/HYDROSTATIC SYSTEM	10-01		
HYDRAULIC SYSTEM INFORMATION.....	20-01		
HYDROSTATIC CONTROLS.....	30-01		
HYDROSTATIC PUMP	30-01		
HYDROSTATIC SYSTEM INFORMATION.....	30-01		
INSTRUMENT PANEL	60-01		



Bobcat®

CONTENTS

FOREWORD.....	II
SAFETY INSTRUCTIONS	V
SERIAL NUMBER LOCATION	IX
DELIVERY REPORT.....	X
BOBCAT LOADER IDENTIFICATION.....	XI
SAFETY AND MAINTENANCE.....	10-01
HYDRAULIC SYSTEM	20-01
HYDROSTATIC SYSTEM.....	30-01
DRIVE SYSTEM	40-01
MAIN FRAME	50-01
ELECTRICAL SYSTEM & ANALYSIS.....	60-01
ENGINE SERVICE	70-01
SPECIFICATIONS.....	SPEC-01

**SAFETY &
MAINTENANCE**

**HYDRAULIC
SYSTEM**

**HYDROSTATIC
SYSTEM**

**DRIVE
SYSTEM**

MAIN FRAME

**ELECTRICAL
SYSTEM &
ANALYSIS**

**ENGINE
SERVICE**

SPECIFICATIONS

FOREWORD

This manual is for the Bobcat loader mechanic. It provides necessary servicing and adjustment procedures for the Bobcat Mini loader and its component parts and systems. Refer to the Operation & Maintenance manual for operating instructions, Starting procedure, daily checks, etc.

A general inspection of the following items must be made after the loader has had service or repair:

1. Check lift arm support device, replace if damaged. (Stored Position)

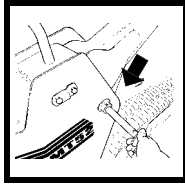

9. Inspect for fuel, oil or hydraulic fluid leaks.

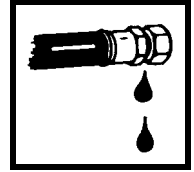

2. Machine signs must be legible and in the correct location.



10. Lubricate the loader.

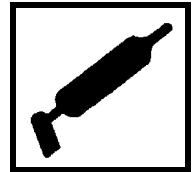

3. Controls must return to neutral.

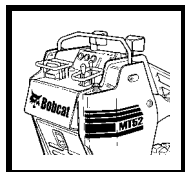

11. Check the condition of the battery and cables.

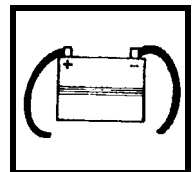

4. (Optional) Check for correct function of the work lights



12. Inspect the air cleaner for damage or leaks. Check the condition of the element.



5. The parking brake must function correctly.

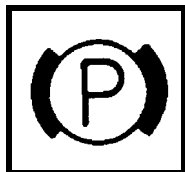

13. Check the electrical charging system.

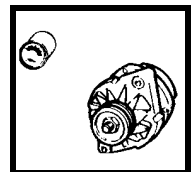

6. Bob-Tach wedges and linkages must function correctly and be in good condition.

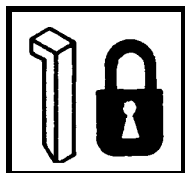

14. Check tracks for wear and pressure.

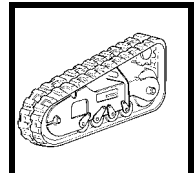

7. Check for correct function of indicator lamps (Optional on some models).

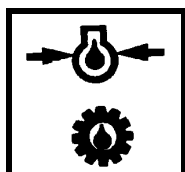

15. Inspect for loose or broken parts or connections.

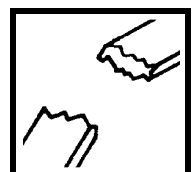

8. Check hydraulic fluid level, engine oil level and fuel supply.

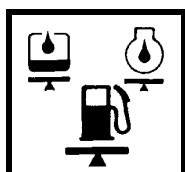

16. Operate the loader and check all functions.



17. Check for any field modification not completed.



18. Check for correct function of lift/tilt lockouts, neutral start interlocks and reverse stop panel.

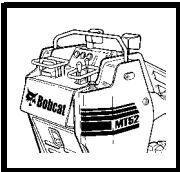

Recommend to the owner that all necessary corrections be made before the machine is returned to service.

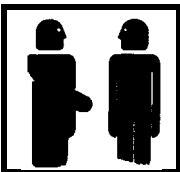

**CALIFORNIA
PROPOSITION 65 WARNING**
Diesel engine exhaust and some of its constituents are known to the State of California to cause cancer, birth defects and other reproductive harm.



Bobcat®

SAFETY INSTRUCTIONS



Instructions are necessary before operating or servicing machine. Read and understand the Operation & Maintenance Manual and signs (decals) on machine. Follow warnings and instructions in the manuals when making repairs, adjustments or servicing. Check for correct function after adjustments, repairs or service. Untrained operators and failure to follow instructions can cause injury or death.

W-2411-1001



Warnings on the machine and in the manuals are for your safety. Failure to obey warnings can cause injury or death.

W-2044-1285



This notice identifies procedures which must be followed to avoid damage to the machine.

I-2019-0284

The following publications provide information on the safe use and maintenance of the Bobcat machine and attachments:

- The Delivery Report is used to assure that complete instructions have been given to the new owner and that the machine is in safe operating condition.
- The Operation & Maintenance Manual delivered with the machine or attachment contains operating information as well as routine maintenance and service procedures. It is a part of the machine and can be stored in a container provided on the machine. Replacement Operation & Maintenance Manuals can be ordered from your Bobcat dealer.
- Machine signs (decals) instruct on the safe operation and care of your Bobcat machine or attachment. The signs and their locations are shown in the Operation & Maintenance Manual. Replacement signs are available from your Bobcat dealer.
- The Service Manual and Parts Manual are available from your dealer for use by mechanics to do shop-type service and repair work.
- The Mini Loader Safety Video is available from your Bobcat dealer or at www.training.bobcat.com or www.bobcat.com.

SI ML-0206 SM

SAFETY INSTRUCTIONS (CONT'D)

The dealer and owner/operator review the recommended uses of the product when delivered. If the owner/operator will be using the machine for a different application(s) he or she must ask the dealer for recommendations on the new use.



Call Before You Dig

1-888-258-0808

When you call, you will be directed to a location in your state/city for information about buried lines (telephone, cable TV, water, sewer, gas, etc.)

SAFETY INSTRUCTIONS (CONT'D)

Fire Prevention

The machine and attachments have components that are at high temperature under normal operating conditions. The primary source of high temperatures is the engine and exhaust system. The electrical system, if damaged or incorrectly maintained, can be a source of arcs or sparks.

Flammable debris (leaves, straw, etc.) must be removed regularly. If flammable debris is allowed to accumulate, it will increase fire hazard. Clean often to avoid this accumulation. Flammable debris in the engine compartment is a potential hazard.

The spark arrestor muffler is designed to control the emission of hot particles from the engine and exhaust system, but the muffler and the exhaust gases are still hot.

- Do not use the machine where exhaust, arcs, sparks or hot components can contact flammable material, explosive dust or gases.
- The operator cab, engine compartment, and engine cooling system must be inspected every day and cleaned if necessary to prevent fire hazard and overheating.
- Check all electrical wiring and connections for damage. Keep the battery terminals clean and tight. Repair or replace any damaged part.
- Check fuel and hydraulic tubes, hoses and fittings for damage and leakage. Never use open flame or bare skin to check for leaks. Tighten or replace any parts that show leakage. Always clean fluid spills. Do not use gasoline or diesel fuel for cleaning parts. Use commercial nonflammable solvents.
- Do not use ether or starting fluids on any engine which has glow plugs. These starting aids can cause explosion and injure you or bystanders.
- Always clean the machine, disconnect the battery, and disconnect the wiring from the controllers before welding. Cover rubber hoses, battery and all other flammable parts. Keep a fire extinguisher near the machine when welding. Have good ventilation when grinding or welding painted parts. Wear a dust mask when grinding painted parts. Toxic dust or gas can be produced.
- Stop the engine and let it cool before adding fuel. **NO SMOKING!**

- Use the procedure in the Operation & Maintenance Manual for connecting the battery and for jump starting.
- Use the procedure in the Operation & Maintenance Manual for cleaning the spark arrestor muffler (if equipped).

Figure 1

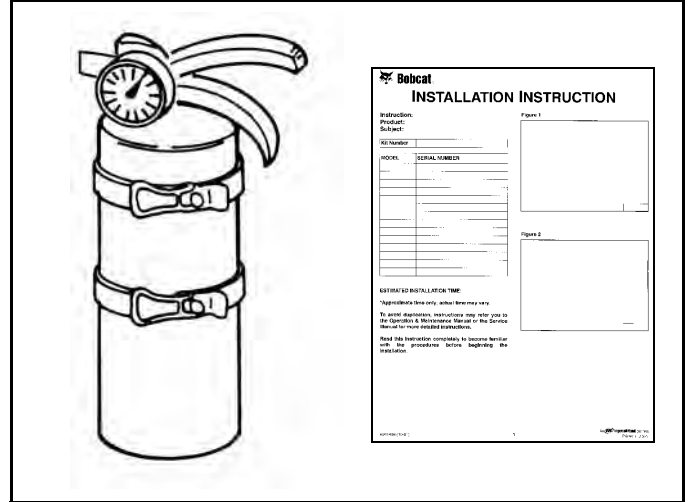

- Know where fire extinguishers and first aid kits are located and how to use them. Fire extinguishers are available from your Bobcat dealer [Figure 1].



Bobcat®

SERIAL NUMBER LOCATION

Always use the serial number of the loader when requesting service information or when ordering parts. Early or later models (identification made by serial number) may use different parts, or it may be necessary to use a different procedure in doing a specific service operation.

Loader Serial Number

Figure 2

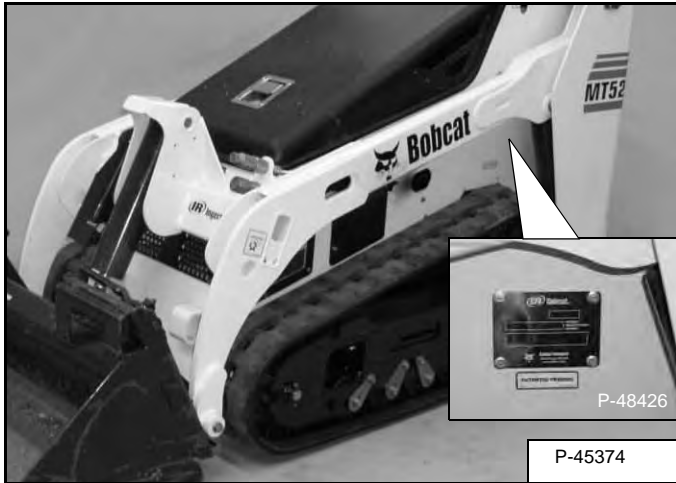

The loader serial number plate is located on the loader frame as shown [Figure 2].

Explanation of loader Serial Number:

XXXX	XXXXX
Model 1.-Model/ Engine Combination	Model 2.-Production Sequence (Series)

1. The four digit Model/Engine Combination Module number identifies the model number and engine combination.
2. The five digit Production Sequence Number identifies the order which the loader is produced.

Engine Serial Number

Figure 3

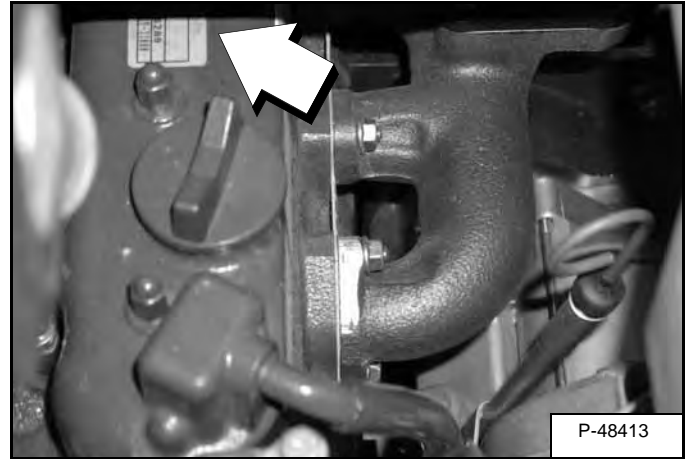

The engine serial number is in the location shown [Figure 2].

DELIVERY REPORT

Figure 4

The diagram shows a form layout with the following sections:

- DELIVERY REPORT** (top right)
- WARNING** (middle left, highlighted)
- Multiple columns of horizontal lines for text entry.
- B-16315** (bottom right)

The Delivery Report must be filled out by the dealer and signed by the owner or operator when the Bobcat loader is delivered. An explanation of the form must be given to the owner. Make sure it is filled out completely **[Figure 4]**.

BOBCAT LOADER IDENTIFICATION

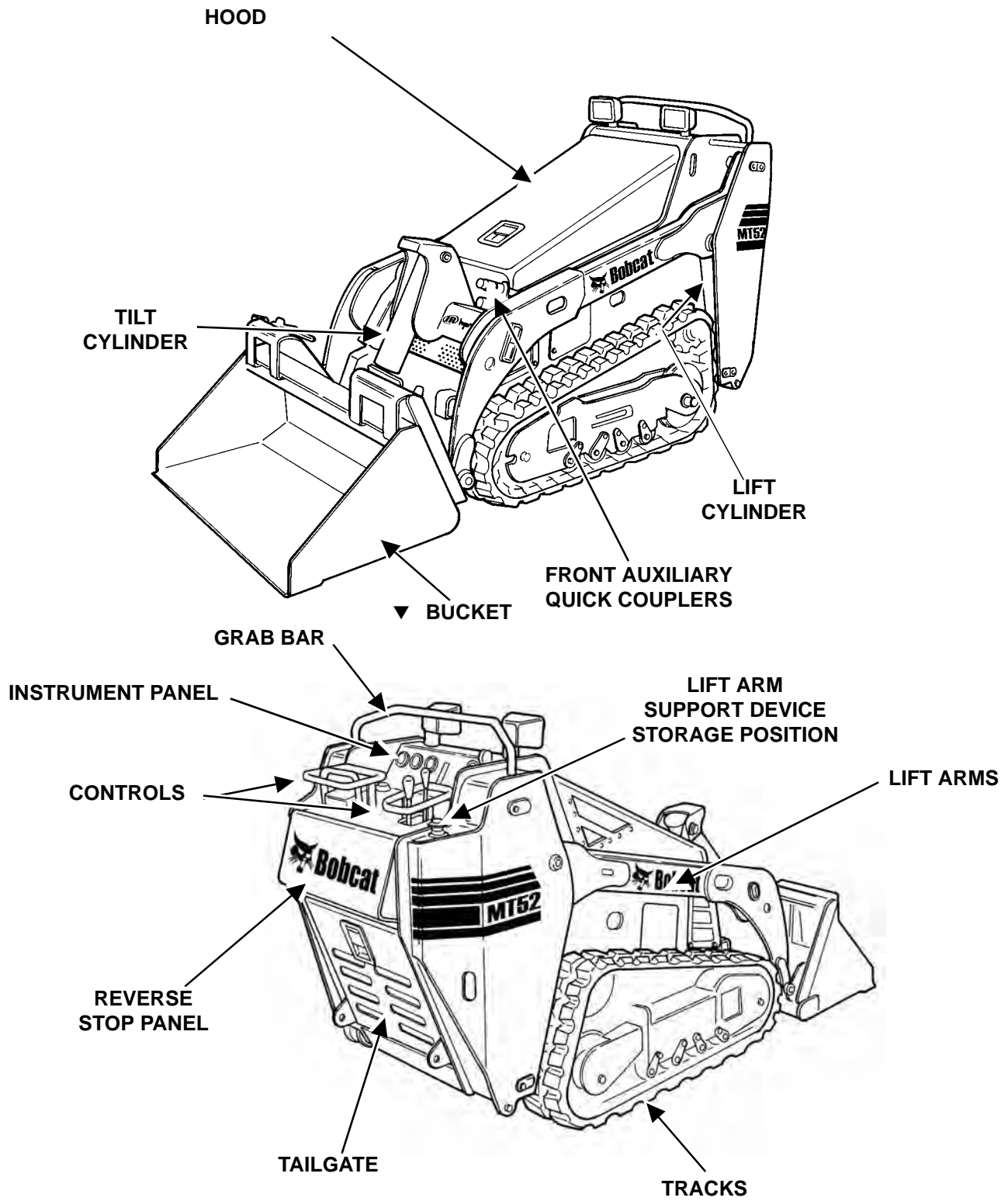

B-19984
B-19999

▼ BUCKET - A bucket and other attachments are available for the Bobcat Mini Loader.



Bobcat®

Dear

**Thanks very much for your visiting and
patience.**

Want to get more information,

Please click here, Go back to the page.

**After your payment, you will have instant access to
your download.**

The Download Link will also be sent to your e-mail.

You will get the complete manual

Have any questions

please write to me

admin@servicemanualperfect.com