

**963**



**Bobcat®**

# Service Manual

(S/N 562215001 & Above)

(S/N 516515001 & Above)



EQUIPPED WITH  
BOBCAT INTERLOCK  
CONTROL SYSTEM (BICS™)



# MAINTENANCE SAFETY



## WARNING

Instructions are necessary before operating or servicing machine. Read and understand the Operation & Maintenance Manual, Operator's Handbook and signs (decals) on machine. Follow warnings and instructions in the manuals when making repairs, adjustments or servicing. Check for correct function after adjustments, repairs or service. Untrained operators and failure to follow instructions can cause injury or death.

W-2003-0903



**Safety Alert Symbol:** This symbol with a warning statement, means: "Warning, be alert! Your safety is involved!" Carefully read the message that follows.

### CORRECT

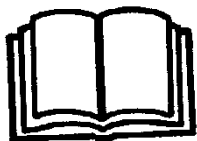

B-10731a

Never service the Bobcat Skid-Steer Loader without instructions.

### CORRECT

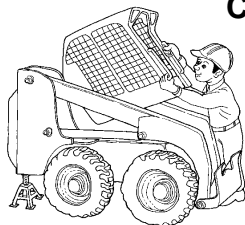

B-15590

Use the correct procedure to lift or lower operator cab.

### CORRECT

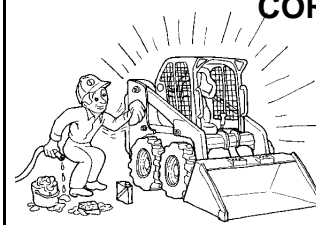

B-15591

Cleaning and maintenance are required daily.

### WRONG

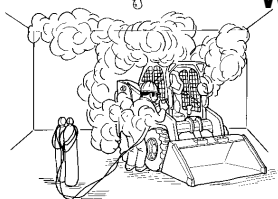

B-15592

- Have good ventilation when welding or grinding painted parts.
- Wear dust mask when grinding painted parts. Toxic dust and gas can be produced.
- Avoid exhaust fume leaks which can kill without warning. Exhaust system must be tightly sealed.

### WRONG

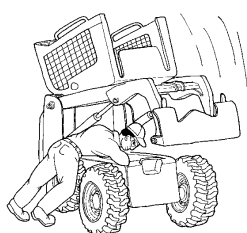

B-15593

Disconnecting or loosening any hydraulic tubeline, hose, fitting, component or a part failure can cause lift arms to drop. Do not go under lift arms when raised unless supported by an approved lift arm support device. Replace it if damaged.

### WRONG

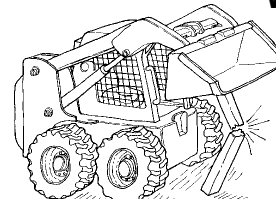

B-15599

- Never work on loader with lift arms up unless lift arms are held by an approved lift arm support device. Replace if damaged.
- Never modify equipment or add attachments not approved by Bobcat Company.

### WRONG

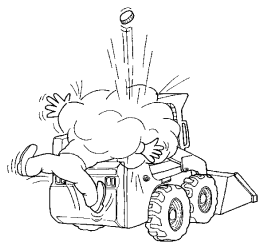

B-15600

- Stop, cool and clean engine of flammable materials before checking fluids.
- Never service or adjust loader with the engine running unless instructed to do so in the manual.
- Avoid contact with leaking hydraulic fluid or diesel fuel under pressure. It can penetrate the skin or eyes.
- Never fill fuel tank with engine running, while smoking or when near open flame.

### WRONG

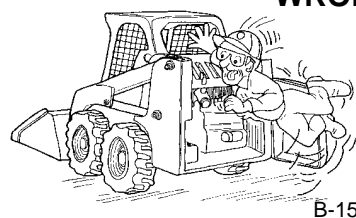

B-15601

- Keep body, jewelry and clothing away from moving parts, electrical contact, hot parts and exhaust.
- Wear eye protection to guard from battery acid, compressed springs, fluids under pressure and flying debris when engines are running or tools are used. Use eye protection approved for type of welding.
- Keep rear door closed except for service. Close and latch door before operating the loader.

### WRONG



B-6589

- Lead-acid batteries produce flammable and explosive gases.
- Keep arcs, sparks, flames and lighted tobacco away from batteries.
- Batteries contain acid which burns eyes or skin on contact. Wear protective clothing. If acid contacts body, flush well with water. For eye contact flush well and get immediate medical attention.

Maintenance procedures which are given in the Operation & Maintenance Manual can be performed by the owner/operator without any specific technical training. Maintenance procedures which are **not** in the Operation & Maintenance Manual must be performed **ONLY BY QUALIFIED BOBCAT SERVICE PERSONNEL**. Always use genuine Bobcat replacement parts. The Service Safety Training Course is available from your Bobcat dealer.

MSW08-0805



**Bobcat®**

## ALPHABETICAL INDEX

AHC SYSTEM.....	60-01	HYDROSTATIC MOTOR.....	30-01
AIR CLEANER.....	70-01	HYDROSTATIC PUMP.....	30-01
AIR CLEANER SERVICE .....	10-01	HYDROSTATIC SYSTEM INFORMATION .....	30-01
AIR CONDITIONING SERVICE.....	80-01	INSTRUMENT PANEL .....	50-01
AIR CONDITIONING SYSTEM FLOW .....	60-01	LIFT ARMS .....	50-01
BASIC TROUBLESHOOTING .....	80-01	LIFT ARM BY-PASS CONTROL VALVE .....	20-01
BATTERY.....	60-01	LIFT ARM SUPPORT DEVICE .....	10-01
BICS™ .....	10-01	LIFTING AND BLOCKING THE LOADER .....	10-01
BICS™ SYSTEM .....	60-01	LIGHTS .....	60-01
BOBCAT CONTROLLER.....	60-01	LOADER SPECIFICATIONS.....	SPEC-01
BOB-TACH.....	50-01	LUBRICATION THE LOADER .....	10-01
BRAKE.....	40-01	MAIN RELIEF VALVE.....	20-01
BUCKET POSITION VALVE .....	20-01	MUFFLER .....	70-01
CHAINCASE .....	40-01	OIL COOLER .....	30-01
CHARGE PRESSURE.....	30-01	OPERATOR CAB.....	10-01, 50-01
COMPONENTS .....	80-01	OPERATOR SEAT .....	50-01
COMPRESSOR.....	80-01	POWER BOB-TACH (OPTION) .....	10-01,50-01
CONDENSER .....	80-01	PRESSURE RELIEF VALVE .....	80-01
CONTROL PANEL.....	30-01	PRESSURE SWITCH .....	80-01
CONTROLS .....	20-01	PWM CONTROL.....	60-01
CONVERSIONS .....	SPEC-01	RADIATOR .....	60-01
COOLING FAN .....	70-01	REAR AUXILIARY DIVERTER .....	20-01
COOLING FAN FILTER .....	20-01	REAR DOOR .....	50-01
CYLINDER(S).....	20-01	REAR GRILL.....	50-01
DIAGNOSTICS SERVICE CODES.....	60-01	RECEIVER/DRIER.....	80-01
DRIVE BELT .....	30-01	RECONDITIONING THE ENGINE.....	70-01
DRIVE COMPONENTS .....	40-01	REGULAR MAINTENANCE.....	80-01
ELECTRICAL/HYDRAULIC CONTROL REF.....	60-01	REMOTE START .....	10-01
ELECTRICAL SYSTEM INFORMATION .....	60-01	SAFETY .....	80-01
ENGINE AND ENGINE MOUNTS .....	70-01	SEAT BAR.....	50-01
ENGINE COMPONENTS AND TESTING .....	70-01	SEAT BAR RESTRAINT SYSTEM.....	10-01
ENGINE COOLING SYSTEM.....	10-01	SEAT BAR SENSOR.....	60-01
ENGINE LUBRICATION SYSTEM .....	10-01	SERVICE SCHEDULE .....	10-01
ENGINE SPEED CONTROL .....	70-01	STARTER.....	60-01
ENGINE SPECIFICATIONS .....	SPEC-01	STEERING .....	30-01
EVAPORATOR .....	80-01	SYSTEM CHARGING AND RECLAMATION.....	80-01
EVAPORATOR/HEATER UNIT.....	80-01	SYSTEM TROUBLEHOOTING CHART .....	80-01
EXPANSION VALVE .....	80-01	TEMPERATURE/PRESSURE.....	80-01
FLYWHEEL AND HOUSING .....	70-01	THERMOSTAT .....	80-01
FUEL SYSTEM.....	10-01	TILT JUNCTION BLOCK.....	20-01
FUEL TANK .....	50-01	TIRE MAINTENANCE .....	10-01
GENERAL AIR CONDITIONING SERVICE		TOWING THE LOADER.....	10-01
GUIDLINES .....	80-01	TORQUE SPECIFICATIONS FOR BOLTS .....	SPEC-01
HAND-LEVER BOB-TACH .....	10-01	TRACTION LOCK .....	60-01
HEATER COIL .....	80-01	TRANSPORTING THE LOADER.....	10-01
HEATER/AC FAN.....	80-01	TROUBLESHOOTING .....	70-01
HEATER VALVE .....	80-01		
HYDRAULIC CONTROL VALVE .....	20-01		
HYDRAULIC CONNECTION SPEC .....	SPEC-01		
HYDRAULIC/HYDROSTATIC FILTER.....	20-01		
HYDRAULIC/HYDROSTATIC FLUID SPEC.....	SPEC-01		
HYDRAULIC FLUID RESERVOIR.....	20-01		
HYDRAULIC PUMP.....	10-01		
HYDRAULIC SYSTEM INFORMATION .....	20-01		
HYDRAULIC/HYDROSTATIC SYSTEM .....	10-01		



**Bobcat®**

## CONTENTS

FOREWORD.....	..II
SAFETY INSTRUCTIONS .....	V
SERIAL NUMBER LOCATIONS .....	IX
DELIVERY REPORT.....	IX
BOBCAT LOADER IDENTIFICATION .....	X
SAFETY & MAINTENANCE .....	10-01
HYDRAULIC SYSTEM .....	20-01
HYDROSTATIC SYSTEM.....	30-01
DRIVE SYSTEM .....	40-01
MAIN FRAME .....	50-01
ELECTRICAL SYSTEM & ANALYSIS.....	60-01
ENGINE SERVICE .....	70-01
HEATING, VENTILATION, AIR CONDITIONING .....	80-01
SPECIFICATIONS.....	SPEC-01

**SAFETY &  
MAINTENANCE**

**HYDRAULIC  
SYSTEM**

**HYDROSTATIC  
SYSTEM**

**DRIVE  
SYSTEM**

**MAIN FRAME**

**ELECTRICAL  
SYSTEM &  
ANALYSIS**

**ENGINE  
SERVICE**

**HVAC**

**SPECIFICATIONS**

# FOREWORD

This manual is for the Bobcat loader mechanic. It provides necessary servicing and adjustment procedures for the Bobcat loader and its component parts and systems. Refer to the Operation & Maintenance Manual for operating instructions, starting procedure, daily checks, etc.

A general inspection of the following items must be made after the loader has had service or repair:

1. Check that the ROPS/FOPS (Including sidescreens) is in good condition and is not modified.

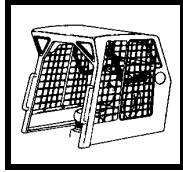

9. The parking brake must function correctly.



2. Check that ROPS mounting hardware is tightened and is Bobcat approved.

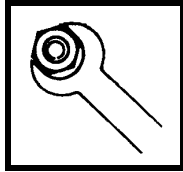

10. Enclosure door latches must open and close freely.

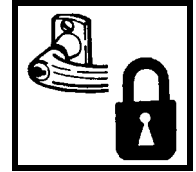

3. The seat belt must be correctly installed, functional and in good condition.

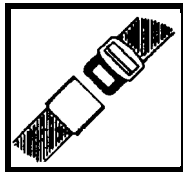

11. Bob-Tach wedges and linkages must function correctly and be in good condition.

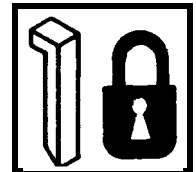

4. The seat bar and pedal interlocks must be correctly adjusted, clean and lubricated.

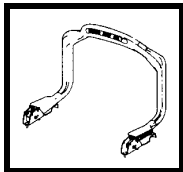

12. Safety treads must be in good condition.

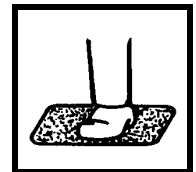

5. Check lift arm support device; replace if damaged.

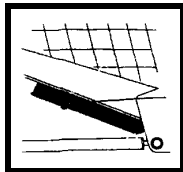

13. Check for correct function of indicator lamps (Optional on some models).

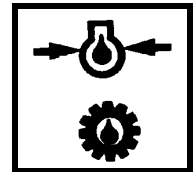

6. Machine signs must be legible and in the correct location.



14. Check hydraulic fluid level, engine oil level and fuel supply.

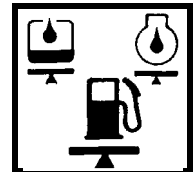

7. Steering levers and foot pedals must return to neutral.

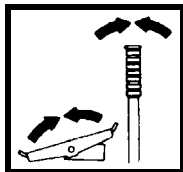

15. Inspect for fuel, oil or hydraulic fluid leaks.

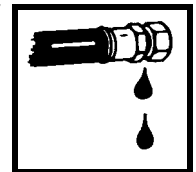

8. Check for correct function of the work lights.



16. Lubricate the loader.





17. Check the condition of the battery and cables.

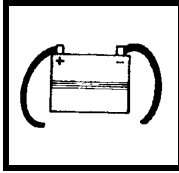

18. Inspect the air cleaner for damage or leaks. Check the condition of the element.

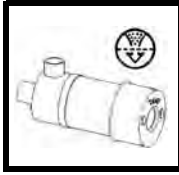

19. Check the electrical charging system.

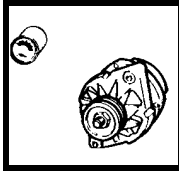

20. Check tracks for wear.

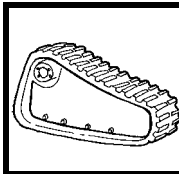

21. Inspect for loose or broken parts or connections.

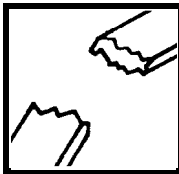

22. Operate the loader and check all functions.



23. Check for any field modification not completed.



24. Check for correct function of the Bobcat Interlock Control System (BICST™) before the machine is returned to the customer.

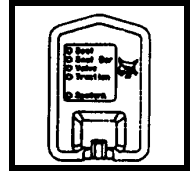

Recommend to the owner that all necessary corrections be made before the machine is returned to service.

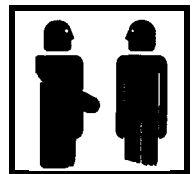

**CALIFORNIA  
PROPOSITION 65 WARNING**  
Diesel engine exhaust and some of its constituents are known to the State of California to cause cancer, birth defects and other reproductive harm.



**Bobcat®**

## SAFETY INSTRUCTIONS



### Safety Alert Symbol

This symbol with a warning statement means:  
“Warning, be alert! Your safety is involved!”  
Carefully read the message that follows.



## WARNING

Instructions are necessary before operating or servicing machine. Read and understand the Operation & Maintenance Manual, Operator's Handbook and signs (decals) on machine. Follow warnings and instructions in the manuals when making repairs, adjustments or servicing. Check for correct function after adjustments, repairs or service. Untrained operators and failure to follow instructions can cause injury or death.

W-2003-0903



## WARNING

Warnings on the machine and in the manuals are for your safety. Failure to obey warnings can cause injury or death.

W-2044-1285

## IMPORTANT

This notice identifies procedures which must be followed to avoid damage to the machine.

I-2019-0284

The following publications provide information on the safe use and maintenance of the Bobcat machine and attachments:

- The Delivery Report is used to assure that complete instructions have been given to the new owner and that the machine is in safe operating condition.
- The Operation & Maintenance Manual delivered with the machine or attachment contains operating information as well as routine maintenance and service procedures. It is a part of the machine and can be stored in a container provided on the machine. Replacement Operation & Maintenance Manuals can be ordered from your Bobcat dealer.
- Machine signs (decals) instruct on the safe operation and care of your Bobcat machine or attachment. The signs and their locations are shown in the Operation & Maintenance Manual. Replacement signs are available from your Bobcat dealer.
- An Operator's Handbook fastened to the operator cab. It's brief instructions are convenient to the operator. The handbook is available from your dealer in an English edition or one of many other languages. See your Bobcat dealer for more information on translated versions.
- The AEM Safety Manual delivered with the machine gives general safety information.
- The Service Manual and Parts Manual are available from your dealer for use by mechanics to do shop-type service and repair work.
- The Skid-Steer Loader Operator Training Course is available through your local dealer or at [www.training.bobcat.com](http://www.training.bobcat.com) or [www.bobcat.com](http://www.bobcat.com). This course is intended to provide rules and practices of correct operation of the Skid-Steer Loader. The course is available in English and Spanish versions.
- Service Safety Training Courses are available from your Bobcat dealer or at [www.training.bobcat.com](http://www.training.bobcat.com) or [www.bobcat.com](http://www.bobcat.com). They provide information for safe and correct service procedures.
- The Skid-Steer Loader Safety Video is available from your Bobcat dealer or at [www.training.bobcat.com](http://www.training.bobcat.com) or [www.bobcat.com](http://www.bobcat.com).

SI SSL-0206 SM

## SAFETY INSTRUCTIONS (CONT'D)

The dealer and owner/operator review the recommended uses of the product when delivered. If the owner/operator will be using the machine for a different application(s) he or she must ask the dealer for recommendations on the new use.

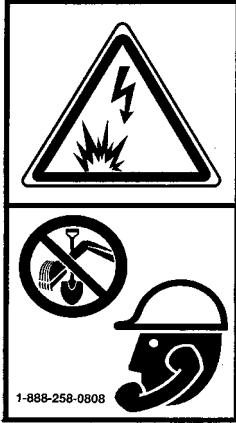

# Call Before You Dig

**1-888-258-0808**

When you call, you will be directed to a location in your state/city for information about buried lines (telephone, cable TV, water, sewer, gas, etc.)

## SAFETY INSTRUCTIONS (CONT'D)

### Fire Prevention

The machine and attachments have components that are at high temperature under normal operating conditions. The primary source of high temperatures is the engine and exhaust system. The electrical system, if damaged or incorrectly maintained, can be a source of arcs or sparks.

Flammable debris (leaves, straw, etc.) must be removed regularly. If flammable debris is allowed to accumulate, it will increase fire hazard. Clean often to avoid this accumulation. Flammable debris in the engine compartment is a potential hazard.

The spark arrestor muffler is designed to control the emission of hot particles from the engine and exhaust system, but the muffler and the exhaust gases are still hot.

- Do not use the machine where exhaust, arcs, sparks or hot components can contact flammable material, explosive dust or gases.
- The operator cab, engine compartment, and engine cooling system must be inspected every day and cleaned if necessary to prevent fire hazard and overheating.
- Check all electrical wiring and connections for damage. Keep the battery terminals clean and tight. Repair or replace any damaged part.
- Check fuel and hydraulic tubes, hoses and fittings for damage and leakage. Never use open flame or bare skin to check for leaks. Tighten or replace any parts that show leakage. Always clean fluid spills. Do not use gasoline or diesel fuel for cleaning parts. Use commercial nonflammable solvents.
- Do not use ether or starting fluids on any engine which has glow plugs. These starting aids can cause explosion and injure you or bystanders.
- Always clean the machine, disconnect the battery, and disconnect the wiring from the controllers before welding. Cover rubber hoses, battery and all other flammable parts. Keep a fire extinguisher near the machine when welding. Have good ventilation when grinding or welding painted parts. Wear a dust mask when grinding painted parts. Toxic dust or gas can be produced.
- Stop the engine and let it cool before adding fuel. **NO SMOKING!**

- Use the procedure in the Operation & Maintenance Manual for connecting the battery and for jump starting.
- Use the procedure in the Operation & Maintenance Manual for cleaning the spark arrestor muffler (if equipped).

Figure 1

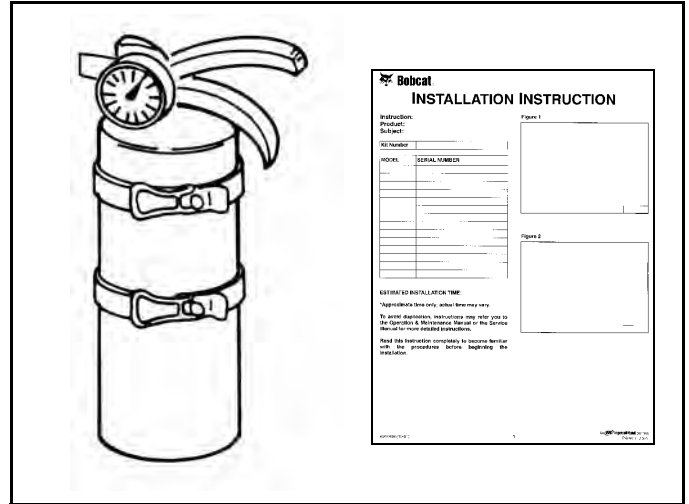

- Know where fire extinguishers and first aid kits are located and how to use them. Fire extinguishers are available from your Bobcat dealer **[Figure 1]**.



**Bobcat®**

## SERIAL NUMBER LOCATIONS

Always use the serial number of the loader when requesting service information or when ordering parts. Early or later models identification made by serial number) may use different parts, or it may be necessary to use a different procedure in doing a specific service operation.

### Loader Serial Number

Figure 2



The loader serial number plate is located on the inside of the left upright, above the grill [Figure 2].

Explanation of loader Serial Number:

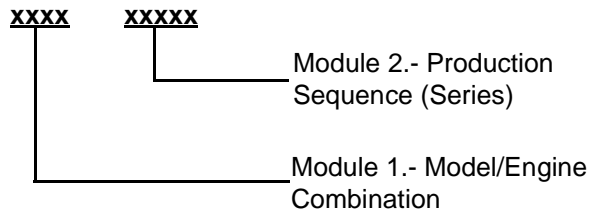

1. The four digit Model/Engine Combination Module number identifies the model number and engine combination.
2. The five digit Production Sequence Number identifies the order which the loader is produced.

### Engine Serial Number

Figure 3

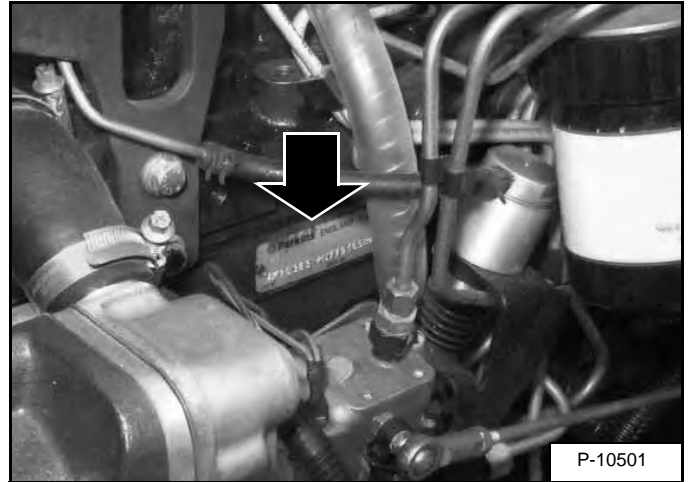

The serial number is on the engine block just above the fuel injection pump [Figure 3].

### DELIVERY REPORT

Figure 4

The Delivery Report must be filled out by the dealer and signed by the owner or operator when the Bobcat loader is delivered. An explanation of the form must be given to the owner. Make sure it is filled out completely [Figure 4].

# BOBCAT LOADER IDENTIFICATION

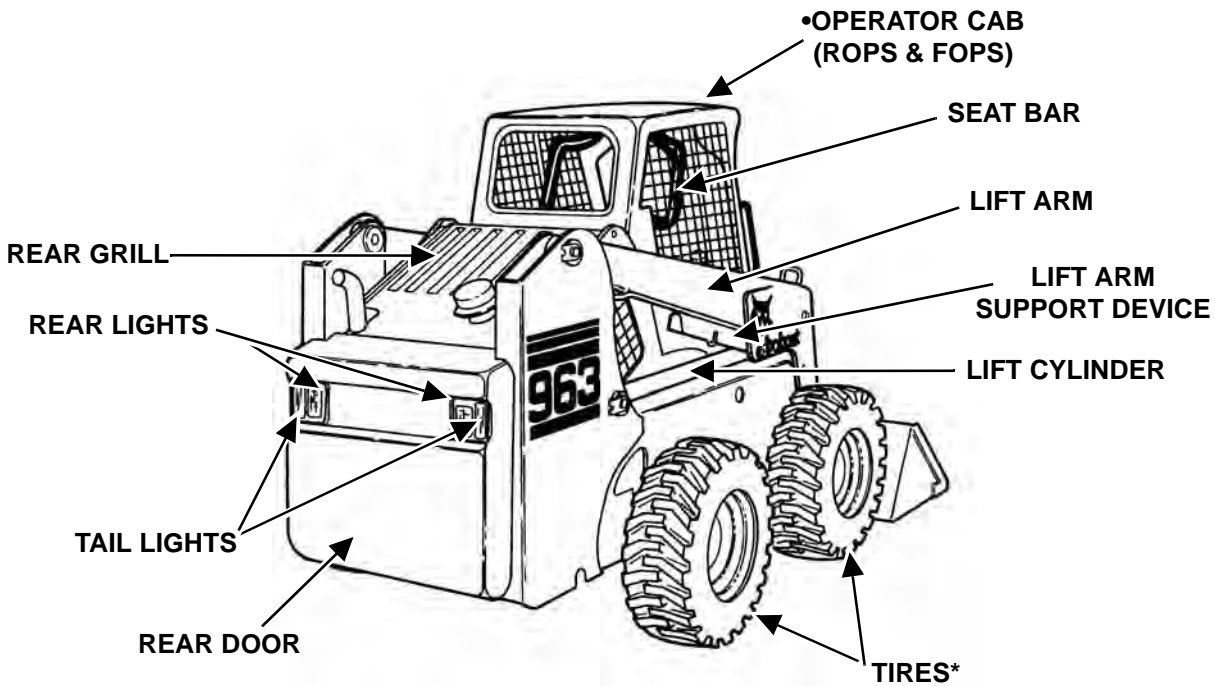
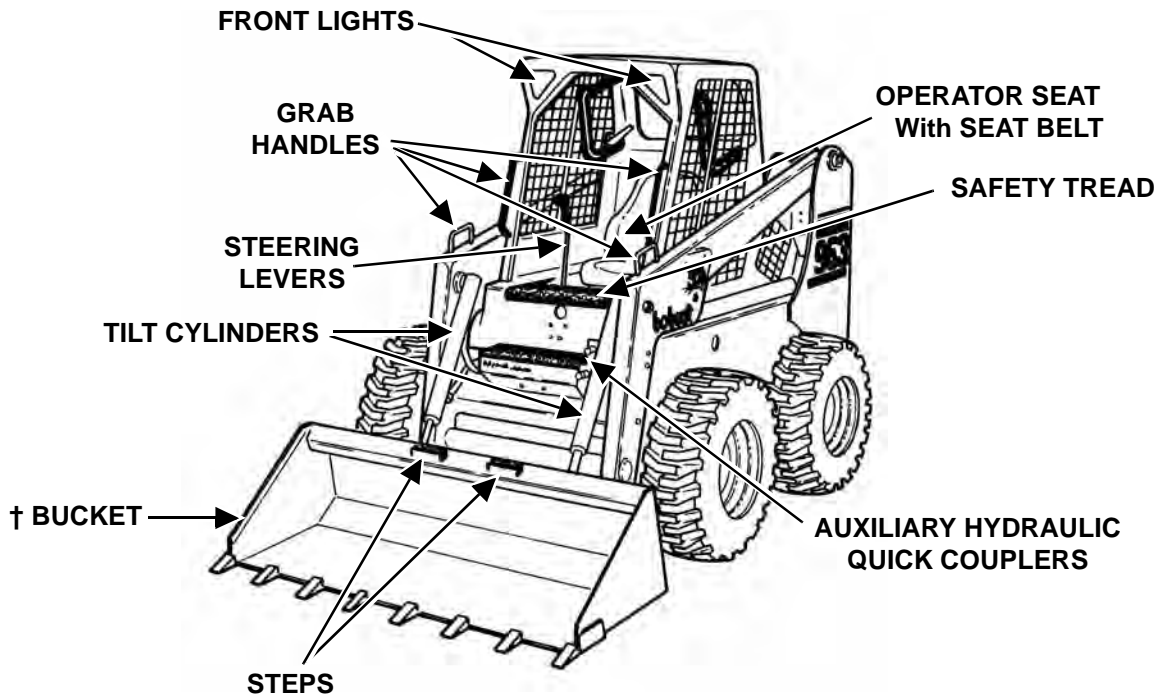

\* **TIRES** - Flotation tires (optional) are shown. The Bobcat loader is factory equipped with standard tires.

† **BUCKET** - Several different buckets and other attachments are available for the Bobcat loader.

• **ROPS, FOPS** - Roll Over Protective Structure, Falling Object Protective Structure, per SAE J1040 and ISO 3471, and Falling Object Protective Structure per SAE J1043 and ISO 3449, Level I. Level II is available. The Bobcat loader is base-equipped with a standard operator cab as shown. Extra insulated cab is available as an option (Reduced noise level).

B-15641  
B-15642



**Dear**

**Thanks very much for your visiting and  
patience.**

**Want to get more information,**

**Please click here, Go back to the page.**

**After your payment, you will have instant access to  
your download.**

**The Download Link will also be sent to your e-mail.**

**You will get the complete manual**

**Have any questions**

**please write to me**

**[admin@servicemanualperfect.com](mailto:admin@servicemanualperfect.com)**