

7  
3  
0

7  
3  
1



# Service Manual

7  
3  
2

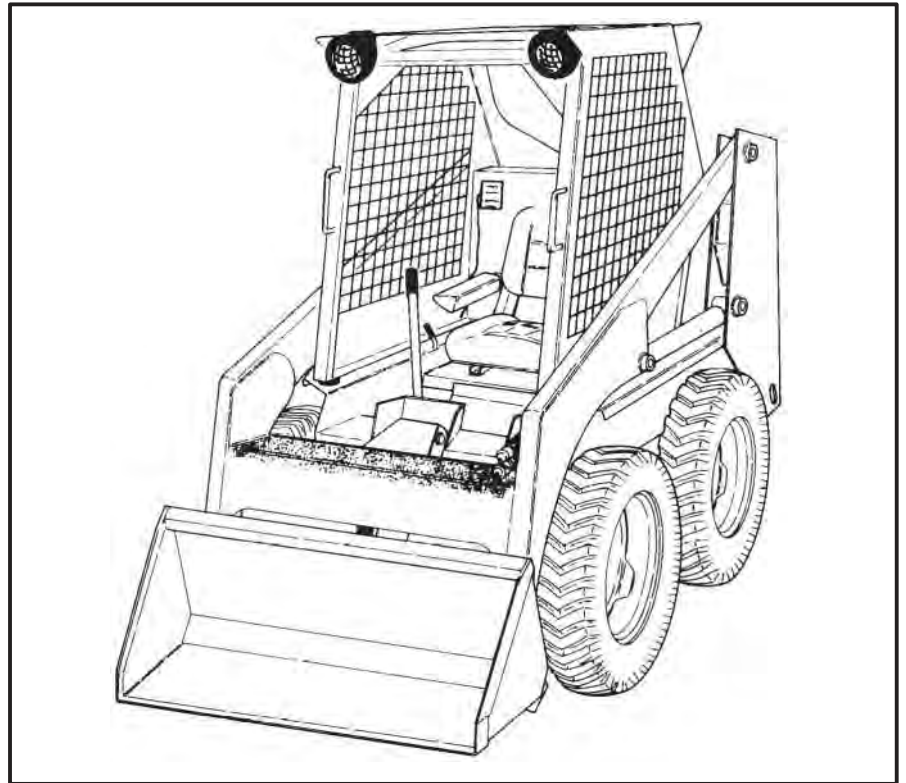

**MELROE**  
**INGERSOLL-RAND**

6556583(4-79)

Printed in U.S.A.



© Melroe Company 1979



# MAINTENANCE SAFETY



## WARNING

Instructions are necessary before operating or servicing machine. Read and understand the Operation & Maintenance Manual, Operator's Handbook and signs (decals) on machine. Follow warnings and instructions in the manuals when making repairs, adjustments or servicing. Check for correct function after adjustments, repairs or service. Untrained operators and failure to follow instructions can cause injury or death.

W-2003-0903



**Safety Alert Symbol:** This symbol with a warning statement, means: "Warning, be alert! Your safety is involved!" Carefully read the message that follows.

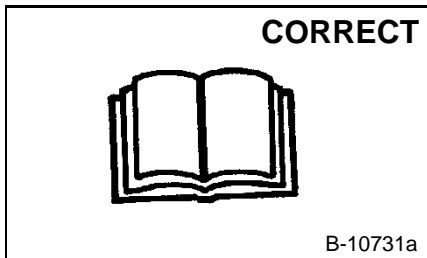

Never service the Bobcat Skid-Steer Loader without instructions.

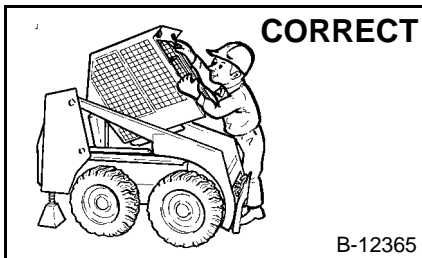

Use the correct procedure to lift or lower operator cab.

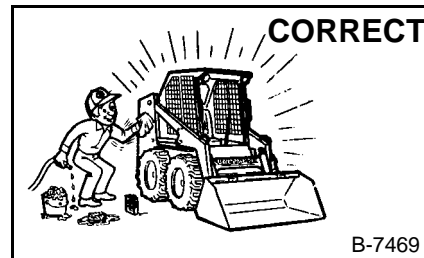

Cleaning and maintenance are required daily.

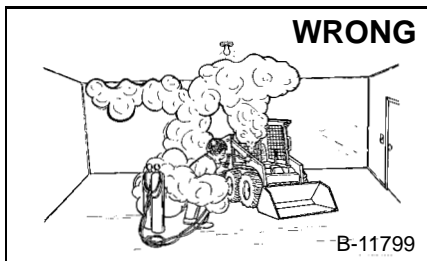

- Have good ventilation when welding or grinding painted parts.
- Wear dust mask when grinding painted parts. Toxic dust and gas can be produced.
- Avoid exhaust fume leaks which can kill without warning. Exhaust system must be tightly sealed.

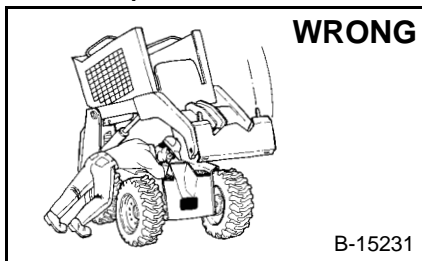

Disconnecting or loosening any hydraulic tubeline, hose, fitting, component or a part failure can cause lift arms to drop. Do not go under lift arms when raised unless supported by an approved lift arm support device. Replace it if damaged.

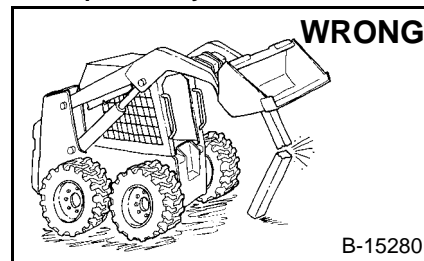

- Never work on loader with lift arms up unless lift arms are held by an approved lift arm support device. Replace if damaged.
- Never modify equipment or add attachments not approved by Bobcat Company.

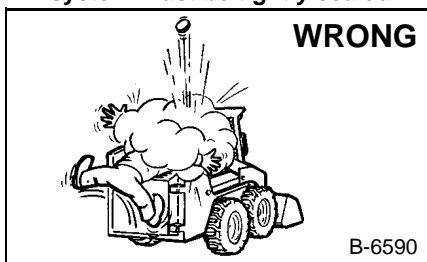

- Stop, cool and clean engine of flammable materials before checking fluids.
- Never service or adjust loader with the engine running unless instructed to do so in the manual.
- Avoid contact with leaking hydraulic fluid or diesel fuel under pressure. It can penetrate the skin or eyes.
- Never fill fuel tank with engine running, while smoking or when near open flame.

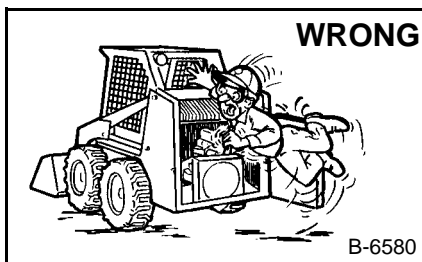

- Keep body, jewelry and clothing away from moving parts, electrical contact, hot parts and exhaust.
- Wear eye protection to guard from battery acid, compressed springs, fluids under pressure and flying debris when engines are running or tools are used. Use eye protection approved for type of welding.
- Keep rear door closed except for service. Close and latch door before operating the loader.

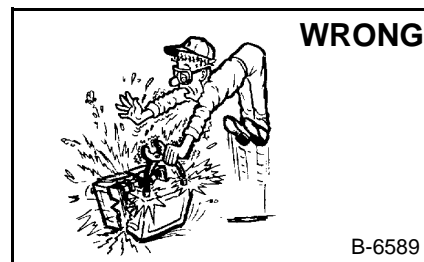

- Lead-acid batteries produce flammable and explosive gases.
- Keep arcs, sparks, flames and lighted tobacco away from batteries.
- Batteries contain acid which burns eyes or skin on contact. Wear protective clothing. If acid contacts body, flush well with water. For eye contact flush well and get immediate medical attention.

Maintenance procedures which are given in the Operation & Maintenance Manual can be performed by the owner/operator without any specific technical training. Maintenance procedures which are **not** in the Operation & Maintenance Manual must be performed **ONLY BY QUALIFIED BOBCAT SERVICE PERSONNEL**. Always use genuine Bobcat replacement parts. The Service Safety Training Course is available from your Bobcat dealer.



**Bobcat®**

# CONTENTS

PREVENTIVE MAINTENANCE .....	1-1
HYDRAULIC SYSTEM .....	2-1
HYDROSTATIC SYSTEM .....	3-1
DRIVE SYSTEM .....	4-1
MAIN FRAME .....	5-1
ELECTRICAL SYSTEM .....	6-1
ENGINE SERVICE .....	7-1
TECHNICAL DATA .....	8-1

**PREVENTIVE  
MAINTENANCE**

**HYDRAULIC  
SYSTEM**

**HYDROSTATIC  
SYSTEM**

**DRIVE  
SYSTEM**

**MAIN  
FRAME**

**ELECTRICAL  
SYSTEM**

**ENGINE  
SERVICE**

**TECHNICAL  
DATA**

**ALPHABETICAL  
INDEX**



# FOREWORD

This manual is for the Bobcat loader mechanic. It provides necessary servicing and adjustment procedures for the Bobcat loader and its component parts and systems. Refer to the Operator's Manual for operating instructions, starting procedure, daily checks, etc.

A general inspection of the following items must be made after the loader has had service or repair:

1. Check that the ROPS/FOPS (Including sidescreens) is in good condition and is not modified.

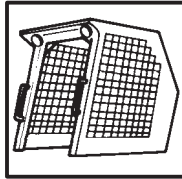

2. Check that ROPS mounting hardware is tightened and is Melroe approved.

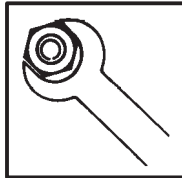

3. The seat belt must be correctly installed, functional and in good condition.

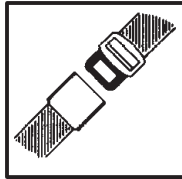

4. The seat bar and pedal interlocks must be correctly adjusted, clean and lubricated.

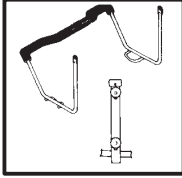

5. Machine signs must be legible and in the correct location.

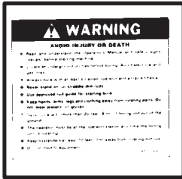

6. Steering levers and foot pedals must return to neutral.

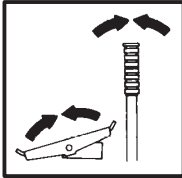

7. Check for correct function of the work lights and travel lights.



8. The parking brake must function correctly.



9. Enclosure door latches must open and close freely.



10. Bob-Tach wedges and linkages must function correctly and be in good condition.

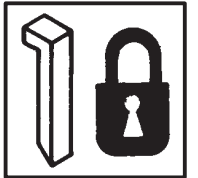

11. Safety treads must in good condition.

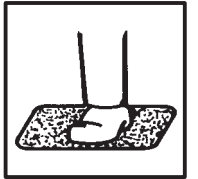

12. Check for correct function of indicator lamps (Optional on some models).

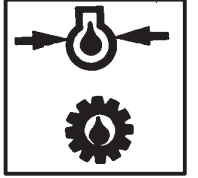

13. Check hydraulic fluid level, engine oil level and fuel supply.

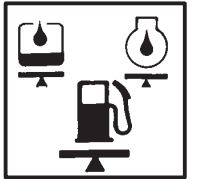

14. Inspect for fuel, oil or hydraulic fluid leaks.

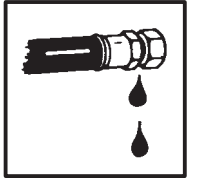

15. Lubricate the loader.



16. Check the condition of the battery and cables.

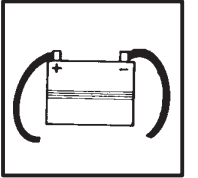

17. Inspect the air cleaner for damage or leaks. Check the condition of the element.

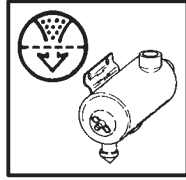

18. Check the electrical charging system.

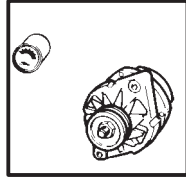

19. Check tires for wear and pressure.

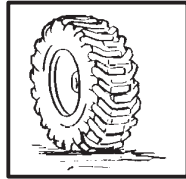

20. Inspect for loose or broken parts or connections.

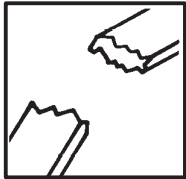

21. Operate the loader and check all functions.

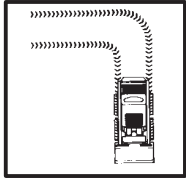

Recommend to the owner that all necessary corrections be made before the machine is returned to service.





# PREVENTIVE MAINTENANCE

## PREVENTIVE MAINTENANCE

	<b>Paragraph Number</b>	<b>Page Number</b>
BOB-TACH AND PIVOT PINS .....	1-8	1-13
ENGINE SERVICE (GENERAL) .....	1-3	1-4
HYDRAULIC FLUID AND FILTER .....	1-4	1-11
INTRODUCTION .....	1-1	1-1
LOADER LUBRICATION .....	1-7	1-13
SERVICE INTERVALS .....	1-2	1-3
TIRES .....	1-6	1-12
TRANSMISSION & DRIVE SYSTEM .....	1-5	1-12



# 1 PREVENTIVE MAINTENANCE

## 1-1 INTRODUCTION

### 1-1.1 Symbols

**IMPORTANT**

This notice identifies important procedures which must be followed to prevent damage to the loader.



**WARNING**

This safety alert symbol indicates important safety messages in this manual. Be alert to the possibility of personal injury and carefully read the message that follows this symbol.

### 1-1.2 Serial Number Identification

It is important to make correct reference to the serial number of the loader when making repairs or ordering parts. It is possible that the present machines do not use all the same parts as earlier machines; or it is possible that different procedures are used for service or repair.

### 1-1.3 Loader Serial Number

The loader serial number plate location is on the inside of the left upright, above the grill (Fig. 1-1).

Explanation of serial number:

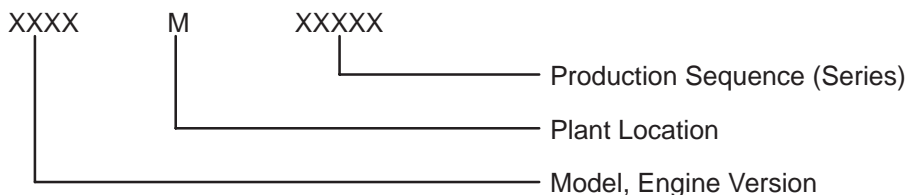

### 1-1.4 Engine Serial Number

**730 Wisconsin:** (Fig. 1-2) The engine serial number location is on the engine shroud on the left side of engine. Use all numbers when ordering parts for this engine.

**731 Deutz:** (Fig. 1-3) The engine serial number location is on the right side of cylinder block. Use all numbers when ordering parts for this engine.

**732 Ford:** (Fig. 1-4) The engine serial number location is on the right side of the valve cover. Use all numbers when ordering parts for this engine.

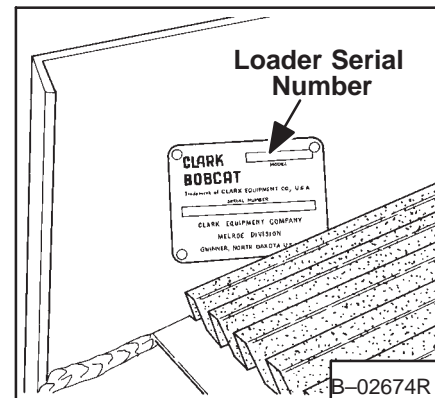

Fig. 1-1 Loader Serial Number

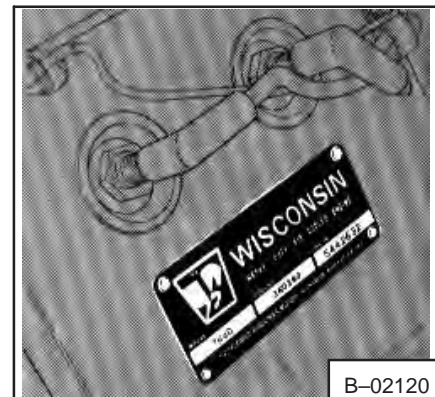

Fig. 1-2 Engine Serial Number (730)

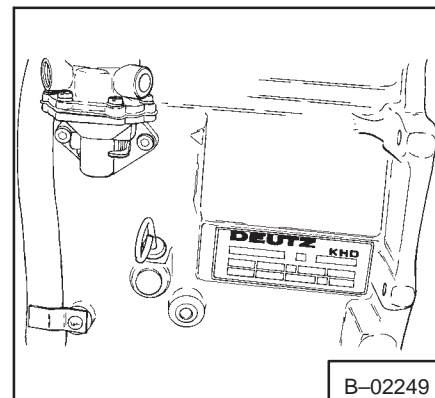

Fig. 1-3 Engine Serial Number (731)

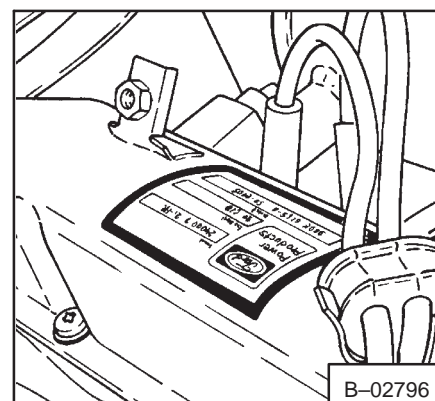

Fig. 1-4 Engine Serial Number (732)

### 1-1.5 Pre-Delivery Inspection

The purpose of the pre-delivery inspection is to make sure that the loader is in correct operation condition when it comes to the dealer and before delivery to the customer.

The pre-delivery inspection also lets the factory know when something is wrong with the loader so that the problem can be corrected and prevented in the future.

All items on the inspection form (Fig. 1-5) must be completed according to specifications in this manual.

Fig. 1-5 Pre-Delivery Inspection

One copy of the completed form is to be mailed to:

**CLARK EQUIPMENT COMPANY  
MELROE DIVISION-SERVICE DEPT.  
GWINNER, NORTH DAKOTA 58040**

The other copy is for the dealer.

### 1-1.6 30 Hour Inspection

The 30-hour inspection must be completed soon after the first 30 hours of operation.

Fig. 1-6 30-Hour Inspection

The purpose of the 30-hour inspection is:

1. For adjustment and inspection after first work period.
2. To correct wrong maintenance and operating methods.
3. For demonstration of correct service procedures to customer.

All items on the 30-hour inspection form (Fig. 1-6) must be completed by the dealer's mechanic, according to specifications in this manual.

When the 30 hour inspection has been completed, the form must be signed by (1) the mechanic that completed the inspection, (2) the dealer, and (3) the owner or operator.

One copy of the completed form is to be mailed to:

**CLARK EQUIPMENT COMPANY  
MELROE DIVISION-SERVICE DEPARTMENT  
GWINNER, NORTH DAKOTA 58040**

One copy is for the owner and one copy is for the dealer.

## 1-2 SERVICE SCHEDULE

Maintenance work must be done at regular intervals. Failure to do so will result in damage to the Bobcat loader or the engine. The service schedule is a guide for correct maintenance of the Bobcat loader. DO NOT change this service schedule unless the frequency of service is increased when the Bobcat loader is operated in very hot, cold, dusty or corrosive conditions.



## WARNING

**DO NOT work on the loader with the lift arms in a raised position without support. Use the lift arm stops or other methods.**

MODEL			SERVICE SCHEDULE	HOURS								
730	731	732		ITEM	SERVICE REQUIRED	8-10	50	100	250	300	500	1000
			Engine Air Cleaner	Clean dust cup. Check condition of system. Check condition indicator.								
			Engine Cooling System	Check coolant level. Add coolant when level is low. Remove debris from the radiator grill area.								
			Tires	Check air pressure & check for damage.								
			Wheel Nuts	Tighten nuts 115 ft.-lbs. (155 Nm) torque.								
			Engine Oil	Check and add oil as needed.								
			All Pivot Points	Add lubricant to all fittings.								
			Engine Cooling Inlet	Check rear door grill & blower inlets for restriction of air flow. Clean cooling fins & blower housing when necessary.								
			Indicators, etc.	Check for correct operation of all.								
			Operator Cab	Check condition of cab & bolts								
			Seat Belt	Check condition of strap, buckle & replace if damaged.								
			Hydraulic Fluid	Check & add recommended fluid as needed.								
			Safety Signs (Decals)	Check for damaged decals or decals that are gone. Replace as needed.								
			Engine Oil & Filter	Change the oil & the filter.								
			Control Pedals & Steering	Add grease to fittings until extra grease shows.								
			Battery	Check water level & cables.								
			Hydraulic Tubes & Hoses	Check for damage or leaks. Replace as needed.								
			V-Belts	Check tension & make adjustments.								
			Crankcase Breather	Clean breather cap every oil change.								
			Bob-Tach	Check locking levers & wedges for condition & operation.								
			Parking Brake	Check operation & adjust as needed.								
			Chaincase Fluid	Check fluid level & add as needed.								
			Hydraulic Filter	Make replacement of filter element.								
			Engine Cylinder Head Bolts	Tighten to correct torque after first 100 hours & adjust the valves as needed.								
			Engine Air Cleaner	Check system for leaks. Replace element when condition indicator shows red.								
			Crankcase Breather	Remove breather & clean.								
			Governor	Check oil level in the reservoir.								
			Main Frame Upright	Check the torque of the bolts that hold the transmission assembly to the upright.								
			Steering Lever Pivots	Grease pivot points.								
			Spark Arrestor Muffler	Remove the plug & clean the spark chamber.								
			Engine Fuel Filter	Replace the filter element.								
			Starting Motor	Remove, clean & service as needed.								
			Engine Fuel Filter (Inline)	Replace the element.								
			Main Fuel Filter	Make replacement of the element. Vent air from the fuel system after changing element.								
			40 Micron Filter	Replace the filter in the port block.								
			Universal Joint	Grease u-joint								
			Engine Compression	The minimum compression reading must be at least 75% of maximum compression reading.								
			Chaincase	Make replacement of fluid.								
			Hydraulic System	Make replacement of fluid & filter. Replace cap.								

## 1-3 ENGINE SERVICE (General)

### 1-3.1 Engine Oil and Filter (Fig. 1-7 thru Fig. 1-10)

#### Oil Specification:

730 and 732: Use a good quality oil which has API Service Classification SE.

731: Use a good quality oil which has API Service Classification CC or CD.

Use oil of correct SAE viscosity for temperature conditions at the time of starting; not for the highest temperature expected during the working day.

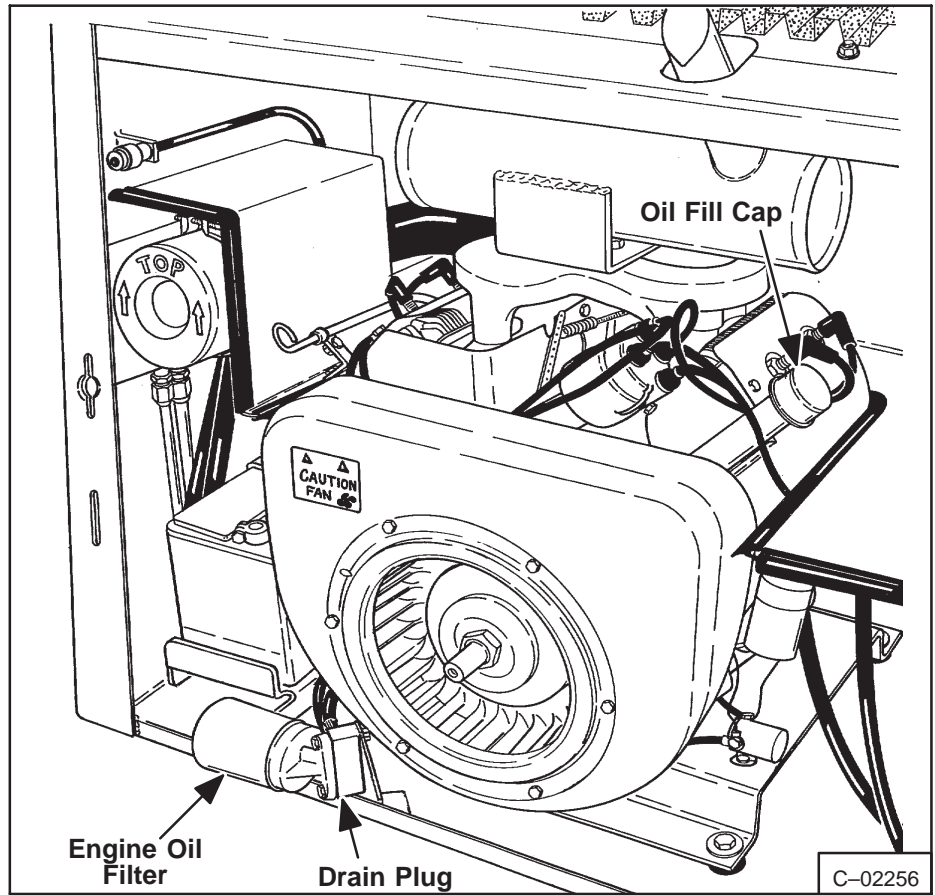

Fig. 1-7 Engine Servicing (730)

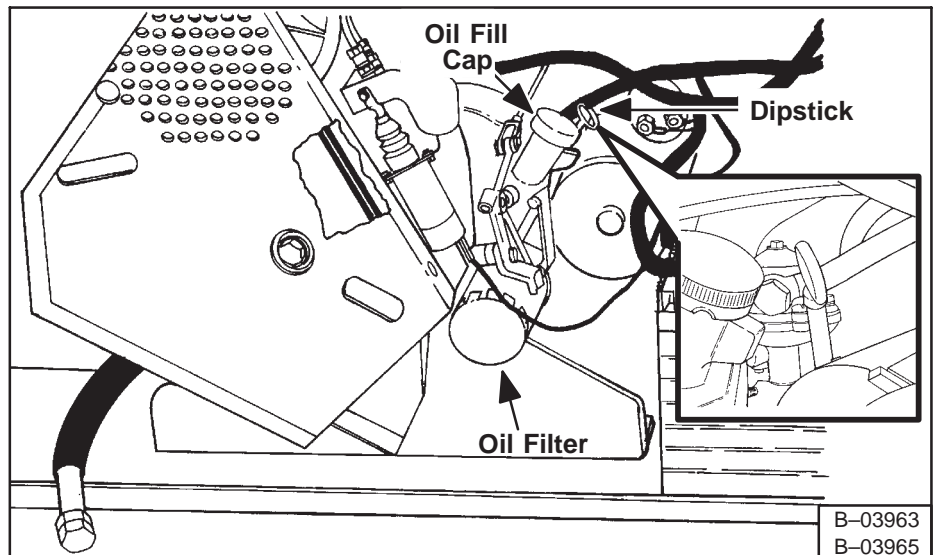
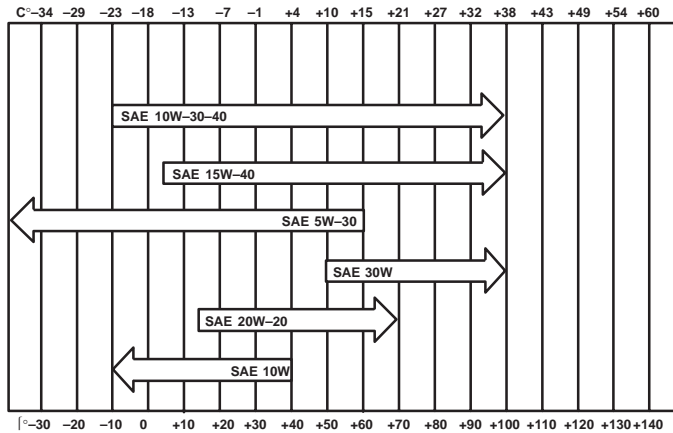

Fig. 1-8 Engine Servicing (731)

**RECOMMENDED SAE VISCOSITY NUMBER  
(LUBRICATION OILS FOR ENGINE CRANKCASE)**



**TEMPERATURE RANGE ANTICIPATED BEFORE NEXT OIL CHANGE  
(GASOLINE: USE API CLASSIFICATION SE)  
(DIESEL: USE API CLASSIFICATION CD)**

**Checking Oil:**

Engine must be stopped to check oil level. Check oil level every 4 hours for the first 50 hours of operation. After the first 50 hours of operation, check oil level every day (8–10 hours). Oil level must be kept between the “MIN” and “MAX” marks on the dipstick.

**Adding Oil:**

Remove oil fill cap and add enough oil of the correct specification and viscosity to make oil level near the “MAX” on the dipstick.

**Replacement Oil and Filter:**

1. Stop the engine.
2. Remove the drain plug when engine is hot.
3. Let oil flow for several minutes.
4. Remove filter.
5. Install drain plug.
6. Clean area around filter base.
7. Put clean oil on gasket of new filter and install new filter. Tighten filter by hand only.
8. Fill with 4 quarts (3,79 l) of oil of the correct specification and viscosity.

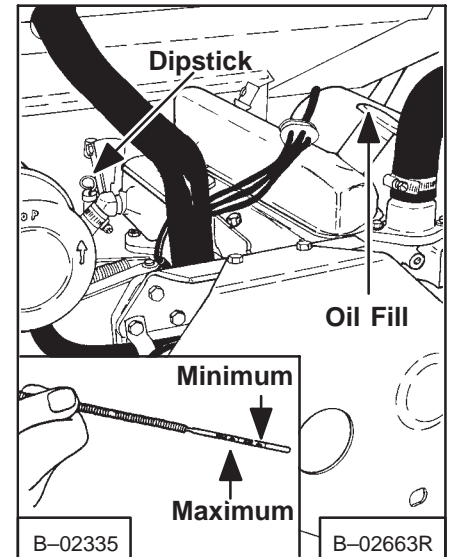

**Fig. 1-9** Checking Crankcase Oil (732)

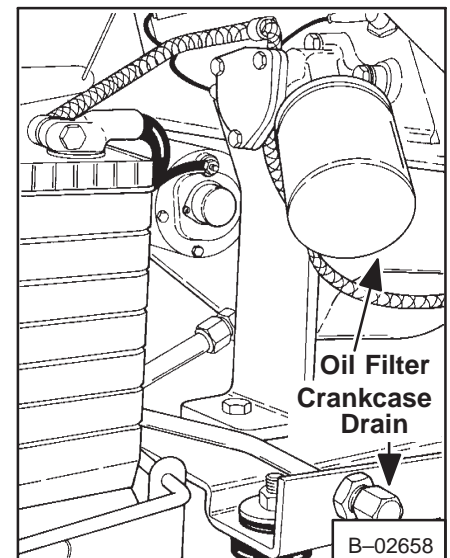

**Fig. 1-10** Engine Oil Filter Location (732)

### 1-3.2 Crankcase Breather

730 Wisconsin: The crankcase breather is a closed system. The breather system must be cleaned every 500 hours.

732 Ford: (Fig. 1-12) The crankcase breather is also the oil fill cap. Clean the breather cap with solvent every time you replace engine oil.

731 Deutz: (Fig. 1-11) The crankcase breather is located on the right side of cylinder block. Clean the breather assembly every 500 hours.

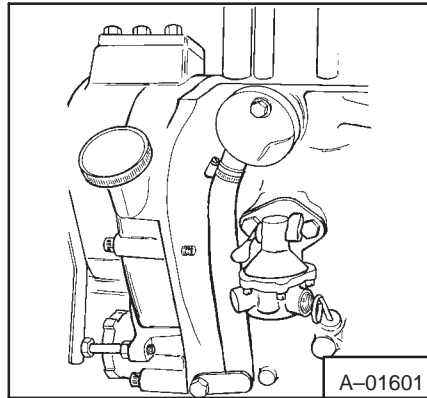

Fig. 1-11 Crankcase Breather (731)

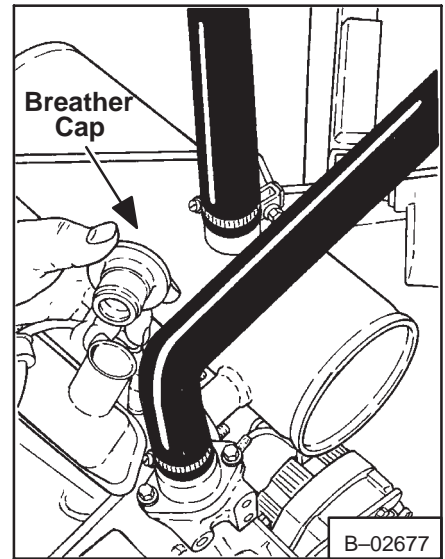

Fig. 1-12 Crankcase Breather (732)

### 1-3.3 Air Cleaner System

The air cleaner system must be kept clean and free from defects for good engine performance and long service life.

Service air cleaner as follows:

1. Remove and clean dust cup every day (Fig. 1-13).
2. Do not remove element unless replacement is necessary. (When condition indicator shows red.)

**NOTE: Be sure (1) gasket surfaces are clean before installing new element and (2) be sure gasket is in correct place.**

3. Inspect complete air cleaner system and make replacement of any parts with defects. Be sure hose connections are tight.
4. Check running operation of air cleaner system as follows:
  - a. Start engine and run at idle.
  - b. Close air inlet on air cleaner. The engine speed must become slower then stop.
  - c. If the engine does not stop, the system has a leak. Inspect, and make repairs as necessary.

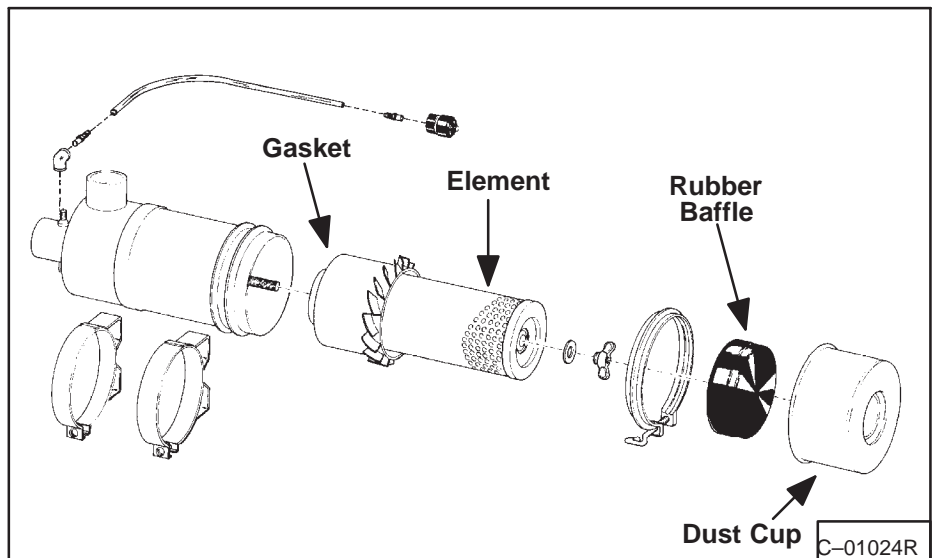

Fig. 1-13 Air Cleaner Assembly

### 1-3.4 Fuel System (730, 732)

Use only "regular" gasoline with an octane rating of 90-94. DO NOT USE UNLEADED GASOLINE.

1. Engine must be stopped, ignition off and engine cool before putting fuel in tank.
2. Remove fuel cap (Fig. 1-14) and fill tank with clean fuel using an approved safety container.
3. Put fuel in the tank ONLY when the machine is in a large open area (outside or a large building).

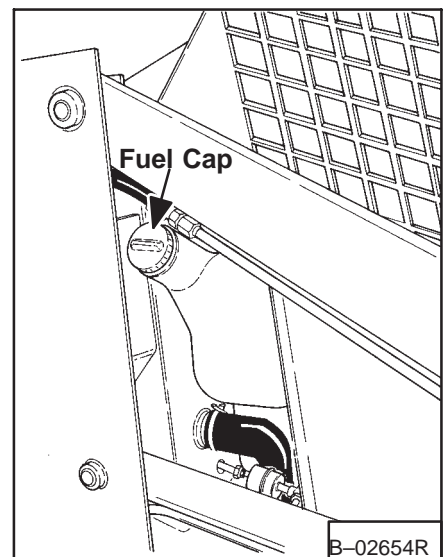

Fig. 1-14 Fuel Filling Location

	<b>WARNING</b>
<b>DO NOT put fuel in tank while near open flames or sparks. DO NOT SMOKE while putting fuel in tank.</b>	



4. Use only clean fuel.
5. Install fuel cap after filling. Be sure cap is tight.

### Fuel Filter (Inline)

A fuel filter is located on the right side of the machine near the fuel tank outlet (Fig. 1-10).

The fuel filter must be checked every 300 hours.

To check or make replacement of fuel filter:

1. Turn fuel valve off (Fig. 1-15).
2. Loosen hose clamp and remove hose from inlet end of fuel filter.
3. Connect a short piece of hose to the outlet end of fuel filter and turn fuel valve on.
4. If fuel goes through the filter, it does not need replacement. If fuel does not go through filter, make replacement.
5. When installing new fuel filter, loosen both hose clamps to remove filter.
6. Install fuel filter with arrow toward carburetor (Fig. 1-15) and be sure fittings are tight.

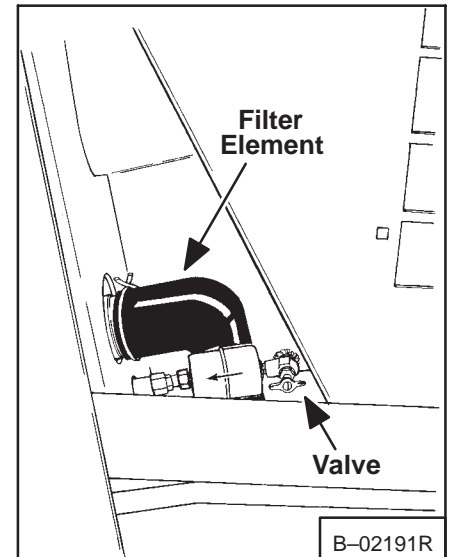

**Fig. 1-15** Fuel Filter and Valve (730, 731)

### 1-3.4a Fuel System (731)

See Section 7 for 731 fuel system maintenance.

### Fuel Pump

730: The fuel pump is located on top of the cylinder block and under the intake manifold. Repair parts are not available for the fuel pump. If the fuel pump does not operate correctly, replacement must be made.

732: The fuel pump is located on the left side of the engine above the starter. Repair parts are not available for the fuel pump. If the fuel pump does not operate correctly, replacement must be made.

### Carburetor

730: The carburetor is located in the center of the engine on top of the intake manifold.

732: The carburetor is located on the left side of the engine, above and behind the fuel pump. Repair kits are available for the carburetor.

730: Carburetor Adjustment (Fig. 1-16).

Adjust the idle screw for the best low speed operation.

The engine must idle at 1125 to 1150 RPM.

Repair kits are available for this carburetor.

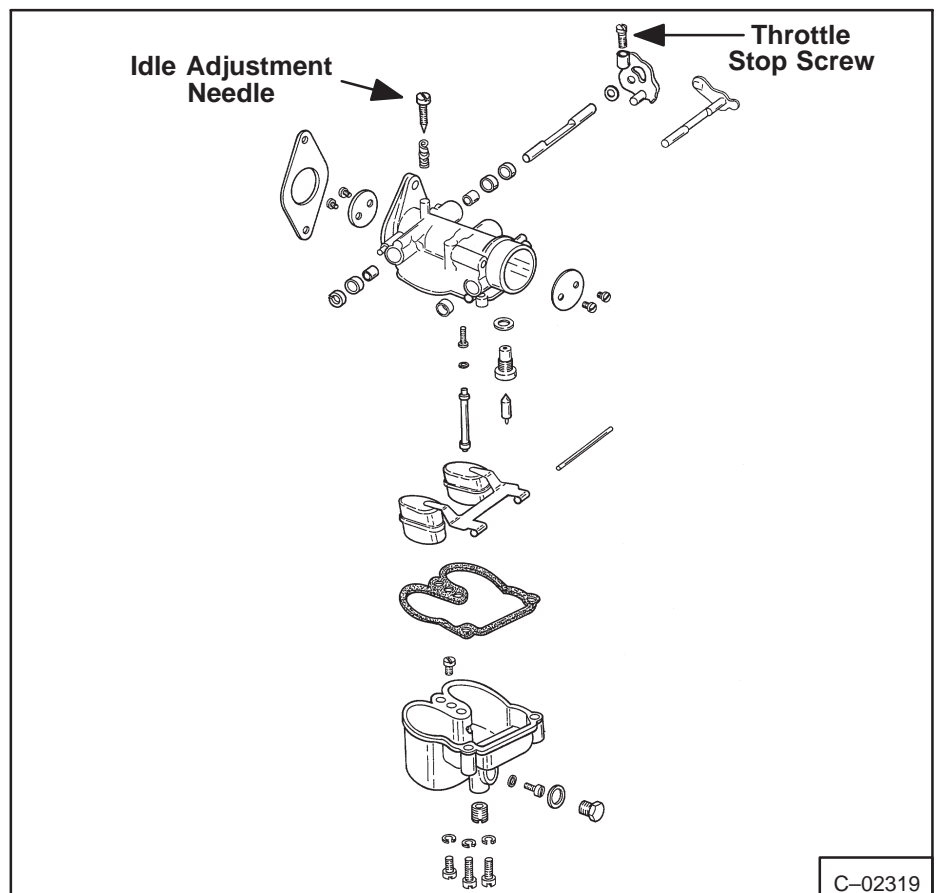

**Fig. 1-16** Carburetor Adjustment (730)

**Dear**

**Thanks very much for your visiting and  
patience.**

**Want to get more information,**

**Please click here, Go back to the page.**

**After your payment, you will have instant access to  
your download.**

**The Download Link will also be sent to your e-mail.**

**You will get the complete manual**

**Have any questions**

**please write to me**

**[admin@servicemanualperfect.com](mailto:admin@servicemanualperfect.com)**