

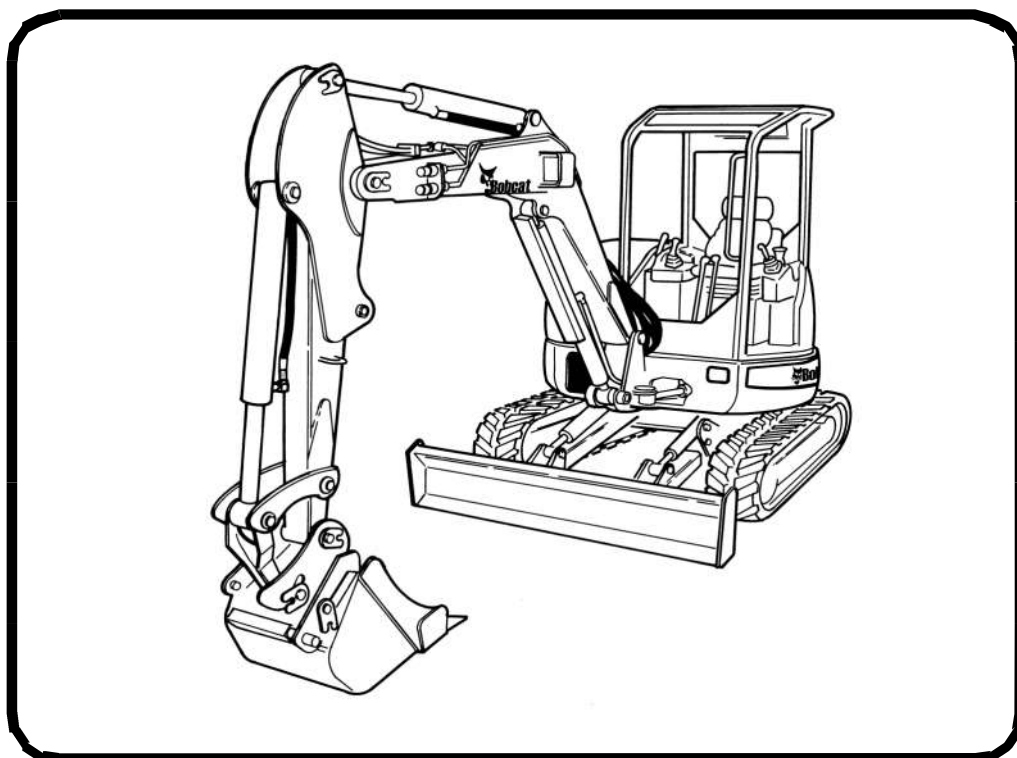

Service Manual

430 Compact Excavator

S/N AA8711001 & Above
S/N AA8811001 & Above
S/N AACF11001 & Above
S/N AACG11001 & Above



MAINTENANCE SAFETY



WARNING

Instructions are necessary before operating or servicing machine. Read and understand the Operation & Maintenance Manual, Operator's Handbook and signs (decals) on machine. Follow warnings and instructions in the manuals when making repairs, adjustments or servicing. Check for correct function after adjustments, repairs or service. Untrained operators and failure to follow instructions can cause injury or death.

W-2003-0807



Safety Alert Symbol: This symbol with a warning statement, means: "Warning, be alert! Your safety is involved!" Carefully read the message that follows.

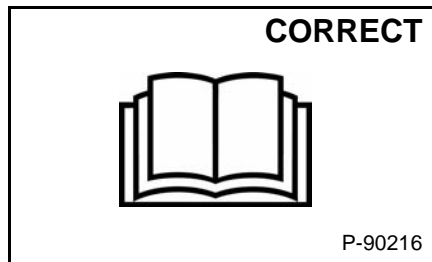

P-90216

- ⚠ Never service the Bobcat Hydraulic Excavator without instructions.

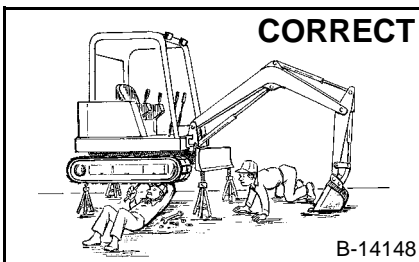

B-14148

- ⚠ Use the correct procedure to lift and support the excavator.
- ⚠ Always lift the blade fully before installing jackstands.

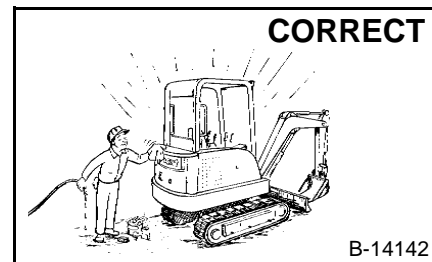

B-14142

- ⚠ Cleaning and maintenance are required daily.

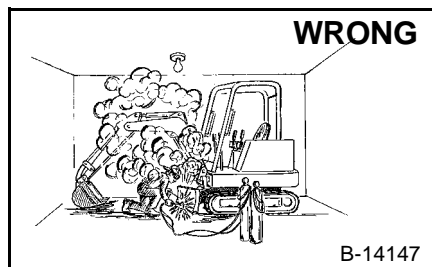

B-14147

- ⚠ Have good ventilation when welding or grinding painted parts.
- ⚠ Wear dust mask when grinding painted parts. Toxic dust and gas can be produced.

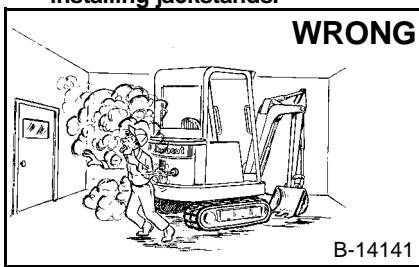

B-14141

- ⚠ Vent exhaust to outside when engine must be run for service.
- ⚠ Exhaust system must be tightly sealed. Exhaust Fumes can kill without warning.

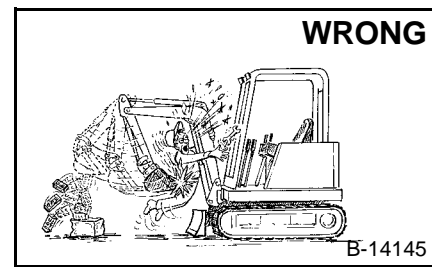

B-14145

- ⚠ Always lower the bucket and blade to the ground before doing any maintenance.
- ⚠ Never modify equipment or add attachments not approved by Bobcat Company.

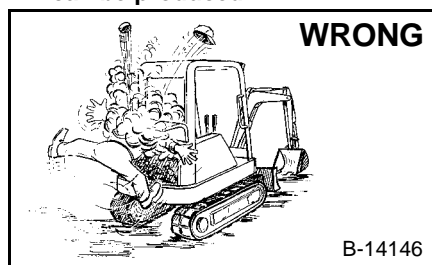

B-14146

- ⚠ Stop, cool and clean engine of flammable materials before checking fluids.
- ⚠ Never service or adjust machine with the engine running unless instructed to do so in the manual.
- ⚠ Avoid contact with leaking hydraulic fluid or diesel fuel under pressure. It can penetrate the skin or eyes.
- ⚠ Never fill fuel tank with engine running, while smoking or when near open flame.

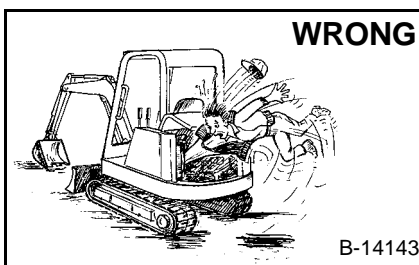

B-14143

- ⚠ Keep body, jewelry and clothing away from moving parts, electrical contact, hot parts and exhaust.
- ⚠ Wear eye protection to guard from battery acid, compressed springs, fluids under pressure and flying debris when engines are running or tools are used. Use eye protection approved for type of welding.
- ⚠ Keep rear door closed except for service. Close and latch door before operating the excavator.



B-6589

- ⚠ Lead-acid batteries produce flammable and explosive gases.
- ⚠ Keep arcs, sparks, flames and lighted tobacco away from batteries.
- ⚠ Batteries contain acid which burns eyes or skin on contact. Wear protective clothing. If acid contacts body, flush well with water. For eye contact flush well and get immediate medical attention.

Maintenance procedures which are given in the Operation & Maintenance Manual can be performed by the owner/operator without any specific technical training. Maintenance procedures which are **not** in the Operation & Maintenance Manual must be performed **ONLY BY QUALIFIED BOBCAT SERVICE PERSONNEL**. Always use genuine Bobcat replacement parts. The Service Safety Training Course is available from your Bobcat dealer.



Bobcat®

ALPHABETICAL INDEX

AIR CLEANER	10-01, 70-01	EVAPORATOR	80-01
AIR CONDITIONING SERVICE	80-01	EVAPORATOR/HEATER UNIT	80-01
AIR CONDITIONING SYSTEM FLOW	80-01	EXPANSION VALVE	80-01
ALTERNATOR	60-01	EXTENDIBLE ARM CYLINDER	20-01
ANGLE BLADE	40-01	FAN/CHARGE PUMP	30-01
ANGLE BLADE ASSEMBLY	40-01	FLOORMAT AND FLOOR PLATES	50-01
ANGLE BLADE CUTTING EDGE	40-01	FUEL, COOLANT AND LUBRICANTS	SPEC-01
ANGLE BLADE CYLINDER	20-01	FUEL LEVEL SENDER	60-01
ANGLE BLADE VALVE	20-01	FUEL SYSTEM	10-01
ARM	50-01	FUEL TANK	50-01
ARM CYLINDER	20-01		
		GENERAL AIR CONDITIONING SERVICE GUIDELINES	
BASIC TROUBLESHOOTING	80-01	80-01
BATTERY	60-01		
BLADE	40-01	HEATER AIR FILTER (WITH CAB OPTION ONLY)	
BLADE CONTROL	50-01	10-01
BLADE CYLINDER	20-01	HEATER COIL	80-01
BLOWER FAN	80-01	HEATER VALVE	80-01
BOOM	50-01	HORN	50-01
BOOM CYLINDER	20-01	HYDRAULIC CONTROL VALVE	20-01
BOOM SWING CYLINDER	20-01	HYDRAULIC CONNECTION SPECS	SPEC-01
BOOM SWING LOCK VALVE	20-01	HYDRAULIC FLUID SPECIFICATIONS	SPEC-01
BUCKET	50-01	HYDRAULIC FILTER MOUNT	20-01
BUCKET CYLINDER	20-01	HYDRAULIC PUMP	20-01
BUILD UP VALVE	20-01	HYDRAULIC PUMP START-UP	20-01
		HYDRAULIC RESERVOIR	20-01
CAB	50-01	HYDRAULIC SYSTEM	10-01
CASE DRAIN FILTER	20-01	HYDRAULIC SYSTEM INFORMATION	20-01
CLAMP	50-01	HYDRAULIC X-CHANGE VALVE	50-01
CLAMP CYLINDER	20-01	HYDROSTATIC PUMP	30-01
COMPONENTS	80-01	HYDROSTATIC SYSTEM INFORMATION	30-01
COMPRESSOR	80-01		
CONDENSOR	80-01	LEFT CONTROL LEVER (JOYSTICK)	20-01
CONVERSIONS	SPEC-01	LEFT CONSOLE	50-01
CONTROL LINKAGE ASSEMBLY	50-01	LIFTING AND BLOCKING THE EXCAVATOR	10-01
CONTROL PATTERN SELECTOR VALVE	20-01	LIFTING THE EXCAVATOR	10-01
COOLING FAN	20-01	LIGHTS	60-01
COOLING SYSTEM	10-01	LOWER TRACK ROLLER	40-01
CROSSPORT RELIEF VALVE	20-01	LUBRICATION OF THE HYDRAULIC EXCAVATOR	
		10-01
DELUXE INSTRUMENT PANEL SETUP	60-01	MAIN RELIEF VALVES	20-01
DIAGNOSTICS SERVICE CODE	60-01	MANIFOLD ASSEMBLY/ACCUMULATOR	20-01
DIRECT TO TANK VALVE	20-01	MUFFLER	70-01
DRIVE BELT	30-01		
DRIVE BELT SHIELD	30-01	OIL COOLER	20-01
		OPERATOR CAB (ROPS/TOPS)	10-01
ELECTRICAL SYSTEM INFORMATION	60-01		
ENGINE	70-01	PORT RELIEF VALVES	20-01
ENGINE ACCESSORY DRIVE BELT	10-01	PRESSURE REDUCING VALVE	20-01
ENGINE COMPONENTS AND TESTING	70-01	PRESSURE RELIEF VALVE	80-01
ENGINE FLYWHEEL	70-01	PRESSURE SWITCH	80-01
ENGINE LUBRICATION SYSTEM	10-01		
ENGINE SPECIFICATIONS	SPEC-01		
ENGINE SPEED CONTROL	50-01		

ALPHABETICAL INDEX (CONT'D)

RADIATOR	70-01
RECEIVER/DRIER	80-01
RECONDITIONING THE ENGINE	70-01
REGULAR MAINTENANCE	80-01
RIGHT CONTROL LEVER (JOYSTICK)	20-01
RIGHT CONSOLE	50-01
RIGHT PEDAL AND LINKAGE.....	50-01
RIGHT SIDE COVER	10-01, 50-01
ROPS CANOPY.....	50-01
SAFETY	80-01
SEAT AND SEAT MOUNT.....	50-01
SERVICE SCHEDULE	10-01
SPARK ARRESTOR MUFFLER.....	10-01
SPECIFICATIONS	SPEC-01
STARTER	60-01
SWING CIRCLE GEAR	40-01
SWING FRAME	50-01
SWING MOTOR	20-01
SWING MOTOR DRIVE CARRIER	20-01
SWIVEL JOINT.....	20-01
SYSTEM CHARGING AND RECLAMATION	80-01
SYSTEM TROUBLESHOOTING CHART	80-01
TAILGATE.....	10-01, 50-01
TEMPERATURE/PRESSURE	80-01
THERMOSTAT.....	80-01
TORQUE SPECIFICATIONS	SPEC-01
TRACK DAMAGE IDENTIFICATION.....	40-01
TRACK FRAME	40-01
TRACK IDLER	40-01
TRACKS	40-01
TRANSPORTING THE EXCAVATOR.....	10-01
TRAVEL CONTROL VALVE	20-01
TRAVEL CONTROLS	50-01
TRAVEL MOTOR.....	10-01, 20-01
TRAVEL PILOT PRESSURE.....	30-01
TROUBLESHOOTING.....	70-01
TWO SPEED SWITCH	60-01
UPPERSTRUCTURE	50-01
UPPERSTRUCTURE SLEW LOCK	10-01, 50-01
UPPER TRACK ROLLER.....	40-01
X-CHANGE	50-01
X-CHANGE (HYDRAULIC).....	50-01

CONTENTS

FOREWORD.....	II
SAFETY INSTRUCTIONS	IV
FIRE PREVENTION	VII
SERIAL NUMBER LOCATIONS	VIII
DELIVERY REPORT.....	IX
BOBCAT EXCAVATOR IDENTIFICATION	X
SAFETY & MAINTENANCE	10-01
HYDRAULIC SYSTEM	20-01
HYDROSTATIC SYSTEM.....	30-01
UNDERCARRIAGE.....	40-01
UPPERSTRUCTURE & SWING SECTION	50-01
ELECTRICAL SYSTEM & ANALYSIS.....	60-01
ENGINE SERVICE	70-01
HEATING, VENTILATION, AIR CONDITIONING	80-01
SPECIFICATIONS.....	SPEC-01

**SAFETY &
MAINTENANCE**

**HYDRAULIC
SYSTEM**

**HYDROSTATIC
SYSTEM**

**UNDER-
CARRIAGE**

**UPPER-
STRUCTURE &
SWING SECTION**

**ELECTRICAL
SYSTEM &
ANALYSIS**

**ENGINE
SERVICE**

HVAC

SPECIFICATIONS

FOREWORD

This manual is for the Bobcat excavator mechanic. It provides necessary servicing and adjustment procedures for the Bobcat excavator and its component parts and systems. Refer to the Operation & Maintenance Manual for operating instructions, starting procedure, daily checks, etc.

A general inspection of the following items must be made after the excavator has had service or repair:

1. Check that the ROPS/TOPS/FOPS is in good condition and is not modified.



9. Safety treads must be in good condition.

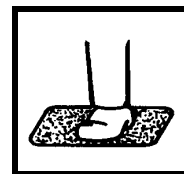

2. Check that ROPS/TOPS mounting hardware is tightened and is Bobcat approved.

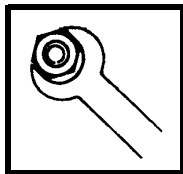

10. Check for correct function of indicator lamps.

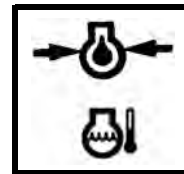

3. The seat belt must be correctly installed, functional and in good condition.

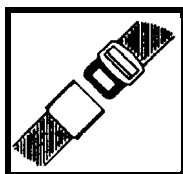

11. Check hydraulic fluid level, engine oil level and fuel supply.

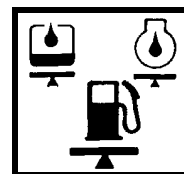

4. Machine signs (decals) must be legible and in the correct location.



12. Inspect for fuel, oil or hydraulic fluid leaks.

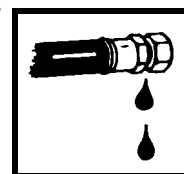

5. Travel levers, control levers and foot pedals must return to neutral. Check that the pedal locks are in working order.

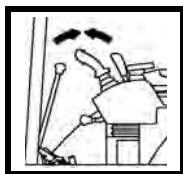

13. Lubricate the excavator.

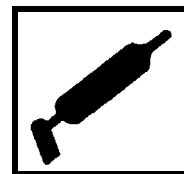

6. Check for correct function of the work lights.



14. Check the condition of the battery and cables.

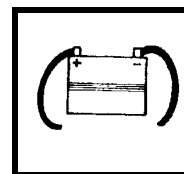

7. Enclosure door latches must open and close freely.

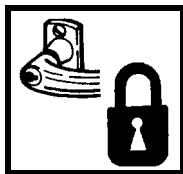

15. Inspect the air cleaner for damage or leaks. Check the condition of the element.

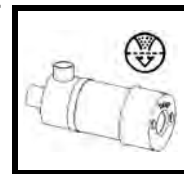

8. Attachment locking pins must function correctly and be in good condition.

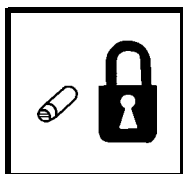

16. Check the electrical charging system.

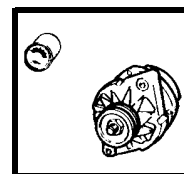

FW EXC-0308 SM

20. Check tracks for wear and tension. Use only approved tracks.

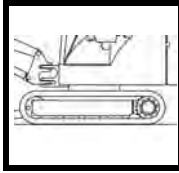

21. Inspect for loose or broken parts or connections.

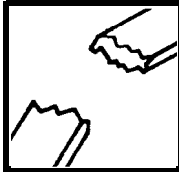

22. Check for any field modification not completed.



23. Operate the machine and check all functions.



24. Check the control console interlocks for correct function.

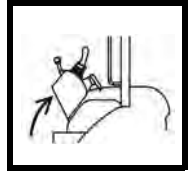

25. Inspect the X-Change for wear or damage. Repair or replace damaged parts.

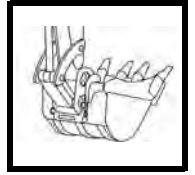

26. Check function or condition of all equipped options and accessories (examples: special applications kit, motion alarm, etc.).



27. Recommend to the owner that all necessary corrections be made before the machine is returned to service.

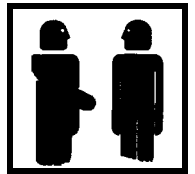

**CALIFORNIA
PROPOSITION 65 WARNING**

Diesel engine exhaust and some of its constituents are known to the state of California to cause cancer, birth defects and other reproductive harm.

SAFETY INSTRUCTIONS



Safety Alert Symbol

This symbol with a warning statement means: “Warning, be alert! Your safety is involved!” Carefully read the message that follows.



WARNING

Instructions are necessary before operating or servicing machine. Read and understand the Operation & Maintenance Manual, Operator’s Handbook and signs (decals) on machine. Follow warnings and instructions in the manuals when making repairs, adjustments or servicing. Check for correct function after adjustments, repairs or service. Untrained operators and failure to follow instructions can cause injury or death.

W-2003-0903

IMPORTANT

This notice identifies procedures which must be followed to avoid damage to the machine.

I-2019-0284



DANGER

The signal word DANGER on the machine and in the manuals indicates a hazardous situation which, if not avoided, will result in death or serious injury.

D-1002-1107



WARNING

The signal word WARNING on the machine and in the manuals indicates a potentially hazardous situation which, if not avoided, could result in death or serious injury.

W-2044-1107

The following publications provide information on the safe use and maintenance of the Bobcat machine and attachments:

- The Delivery Report is used to assure that complete instructions have been given to the new owner and that the machine is in safe operating condition.
- The Operation & Maintenance Manual delivered with the machine or attachment contains operating information as well as routine maintenance and service procedures. It is a part of the machine and can be stored in a container provided on the machine. Replacement Operation & Maintenance Manuals can be ordered from your Bobcat dealer.
- Machine signs (decals) instruct on the safe operation and care of your Bobcat machine or attachment. The signs and their locations are shown in the Operation & Maintenance Manual. Replacement signs are available from your Bobcat dealer.
- An Operator’s Handbook fastened to the operator cab. It’s brief instructions are convenient to the operator. The handbook is available from your dealer in an English edition or one of many other languages. See your Bobcat dealer for more information on translated versions.
- The AEM Safety Manual delivered with the machine gives general safety information.
- The Service Manual and Parts Manual are available from your dealer for use by mechanics to do shop-type service and repair work.
- The Compact Excavator Operator Training Course is available through your local dealer or at www.training.bobcat.com or www.bobcat.com. This course is intended to provide rules and practices of correct operation of the Bobcat excavator. The course is available in English and Spanish versions.
- Service Safety Training Courses are available from your Bobcat dealer or at www.training.bobcat.com or www.bobcat.com. They provide information for safe and correct service procedures.
- The Bobcat compact excavator Safety Video is available from your Bobcat dealer or at www.training.bobcat.com or www.bobcat.com.

SI EXC-0308 SM

SAFETY INSTRUCTIONS (CONT'D)

The dealer and owner / operator review the recommended uses of the product when delivered. If the owner / operator will be using the machine for a different application(s) he or she must ask the dealer for recommendations on the new use.



Cutting or drilling concrete containing sand or rock containing quartz may result in exposure to silica dust. Do not exceed Permissible Exposure Limits (PEL) to silica dust as determined by OSHA or other job site Rules and Regulations. Use a respirator, water spray or other means to control dust. Silica dust can cause lung disease and is known to the state of California to cause cancer.

Call Before You Dig
Dial 811 (USA Only)
1-888-258-0808 (USA & Canada)

When you call, you will be directed to a location in your state / province, or city for information about buried lines (telephone, cable TV, water, sewer, gas, etc.).

FIRE PREVENTION



Maintenance

The machine and some attachments have components that are at high temperatures under normal operating conditions. The primary source of high temperatures is the engine and exhaust system. The electrical system, if damaged or incorrectly maintained, can be a source of arcs or sparks.

Flammable debris (leaves, straw, etc.) must be removed regularly. If flammable debris is allowed to accumulate, it can cause a fire hazard. Clean often to avoid this accumulation. Flammable debris in the engine compartment is a potential fire hazard.

The operator's area, engine compartment and engine cooling system must be inspected every day and cleaned if necessary to prevent fire hazards and overheating.

All fuels, most lubricants and some coolants mixtures are flammable. Flammable fluids that are leaking or spilled onto hot surfaces or onto electrical components can cause a fire.

Operation

Do not use the machine where exhaust, arcs, sparks or hot components can contact flammable material, explosive dust or gases.

Electrical



Check all electrical wiring and connections for damage. Keep the battery terminals clean and tight. Repair or replace any damaged part or wires that are loose or frayed.

Battery gas can explode and cause serious injury. Use the procedure in the Operation & Maintenance Manual for connecting the battery and for jump starting. Do not jump start or charge a frozen or damaged battery. Keep any open flames or sparks away from batteries. Do not smoke in battery charging area.

Hydraulic System

Check hydraulic tubes, hoses and fittings for damage and leakage. Never use open flame or bare skin to check for leaks. Hydraulic tubes and hoses must be properly routed and have adequate support and secure clamps. Tighten or replace any parts that show leakage.

Always clean fluid spills. Do not use gasoline or diesel fuel for cleaning parts. Use commercial nonflammable solvents.

Fueling



Stop the engine and let it cool before adding fuel. No smoking! Do not refuel a machine near open flames or sparks. Fill the fuel tank outdoors.

Starting

Do not use ether or starting fluids on any engine that has glow plugs. These starting aids can cause explosion and injure you or bystanders.

Use the procedure in the Operation & Maintenance Manual for connecting the battery and for jump starting.

Spark Arrestor Exhaust System

The spark arrestor exhaust system is designed to control the emission of hot particles from the engine and exhaust system, but the muffler and the exhaust gases are still hot.

Check the spark arrestor exhaust system regularly to make sure it is maintained and working properly. Use the procedure in the Operation & Maintenance Manual for cleaning the spark arrestor muffler (if equipped).

FIRE PREVENTION (CONT'D)

Welding And Grinding

Always clean the machine and attachment, disconnect the battery, and disconnect the wiring from the Bobcat controllers before welding. Cover rubber hoses, battery and all other flammable parts. Keep a fire extinguisher near the machine when welding.

Have good ventilation when grinding or welding painted parts. Wear dust mask when grinding painted parts. Toxic dust or gas can be produced.

Dust generated from repairing nonmetallic parts such as hoods, fenders or covers can be flammable or explosive. Repair such components in a well ventilated area away from open flames or sparks.

Fire Extinguishers

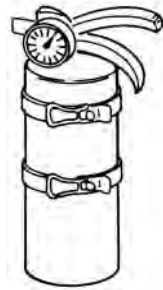

Know where fire extinguishers and first aid kits are located and how to use them. Inspect the fire extinguisher and service the fire extinguisher regularly. Obey the recommendations on the instructions plate.

SERIAL NUMBER LOCATIONS

Always use the serial number of the excavator when requesting service information or when ordering parts. Early or later models (identification made by serial number) may use different parts, or it may be necessary to use a different procedure in doing a specific service operation.

Figure 1

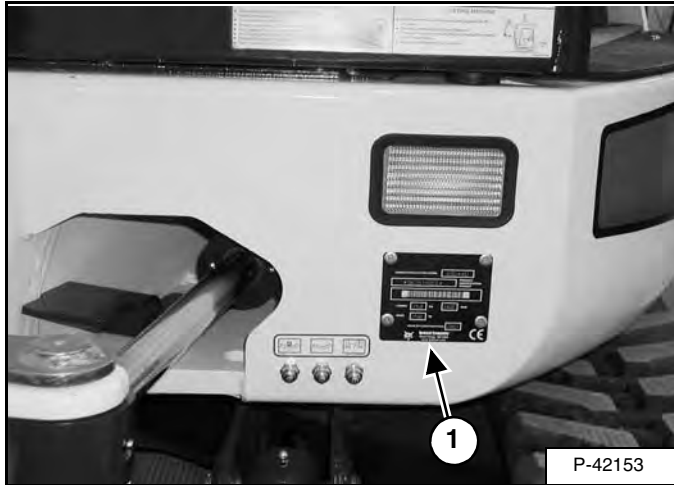

Excavator Serial Number

The excavator serial number plate (Item 1) [Figure 1] is located on the frame of the machine in the location shown.

Explanation of Excavator Serial Number:

XXXX XXXXX

Module 2. - Production Sequence (Series)

Module 1. - Model / Engine Combination

1. The 4 digit Model/Engine Combination Module number identifies the model number and engine combination.

2. The 5 digit Production Sequence Number identifies the order which the excavator is produced.

Engine Serial Number

Figure 2

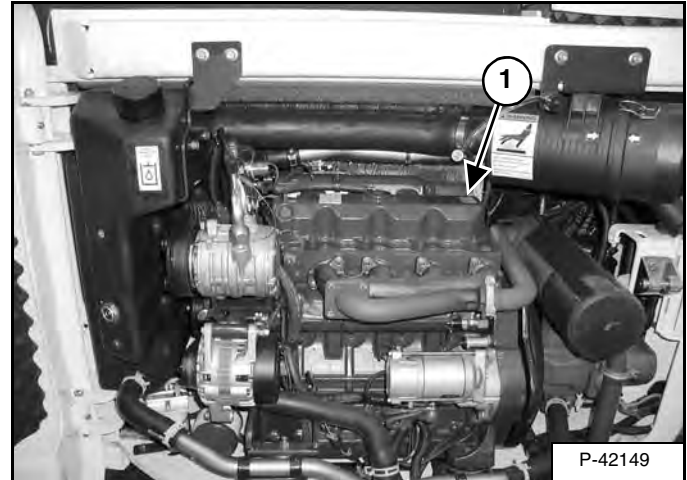
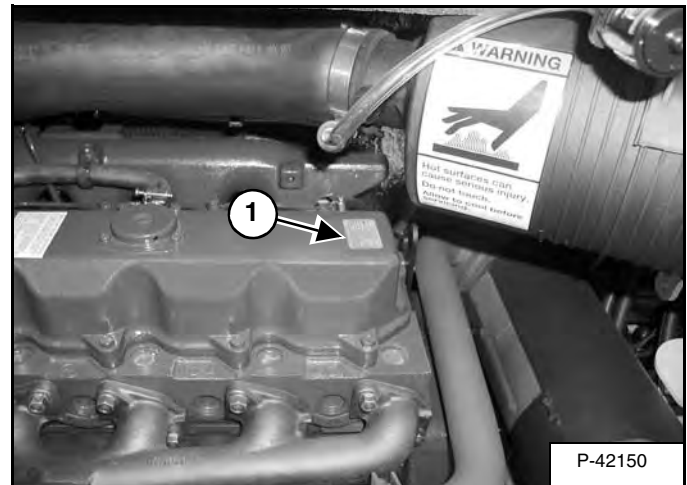

Figure 3



The engine serial number (Item 1) [Figure 2] & [Figure 3] is located on the engine in the location shown.

DELIVERY REPORT

Figure 4

The diagram shows a form titled "DELIVERY REPORT" with a "WARNING" section and a reference code "B-16315".

The delivery report must be filled out by the dealer and signed by the owner or operator when the Bobcat Excavator is delivered. An explanation of the form must be given to the owner. Make sure it is filled out completely [Figure 4].

BOBCAT EXCAVATOR IDENTIFICATION

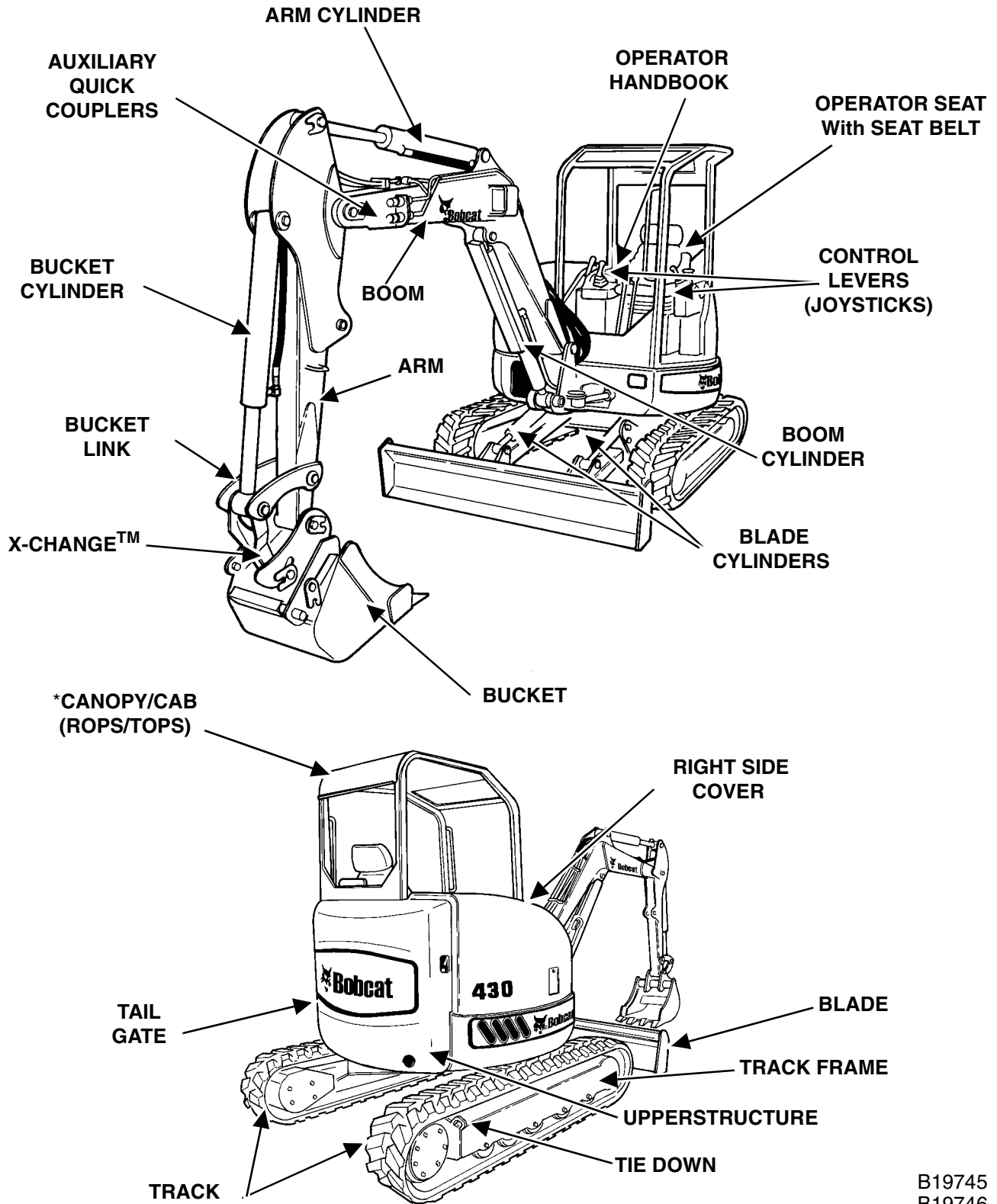

B19745
B19746

* FOGS (Falling Object Guards) is available from your Bobcat Excavator dealer.

SAFETY & MAINTENANCE

AIR CLEANER 10-60-1
 Daily Check 10-60-1
 Replacing The Elements 10-60-1

ENGINE COOLING SYSTEM 10-70-1
 Checking Coolant Level 10-70-1
 Cleaning The Cooling System 10-70-1
 Removing And Replacing Coolant 10-70-2

ALTERNATOR BELT 10-140-1
 Belt Adjustment 10-140-1
 Belt Tension 10-140-1

ENGINE LUBRICATION SYSTEM 10-90-1
 Checking And Adding Engine Oil 10-90-1
 Removing And Replacing Oil And Filter 10-90-1
 Engine Oil Chart 10-90-1

EXCAVATOR STORAGE AND RETURN TO SERVICE 10-170-1
 Return to Service 10-170-1
 Storage 10-170-1

FUEL SYSTEM 10-80-1
 Biodiesel Blend Fuel 10-80-1
 Draining The Fuel Tank 10-80-4
 Filling The Fuel Tank 10-80-2
 Fuel Specifications 10-80-1
 Inline Fuel Filter 10-80-4
 Removing Air From The Fuel System 10-80-4
 Removing Water 10-80-3
 Replacing Element 10-80-3

HEATER AIR FILTER (WITH CAB OPTION ONLY) 10-61-1
 Removal And Installation 10-61-1

HYDRAULIC SYSTEM 10-100-1
 Checking And Adding Fluid 10-100-1
 Diagnostic Couplers 10-100-5
 Hydraulic Fluid Chart 10-100-2
 Removing And Replacing The Fan Filter 10-100-5
 Removing And Replacing The Case Drain Filter 10-100-4
 Removing And Replacing The Hydraulic Filter 10-100-4
 Removing And Replacing The Hydraulic Fluid 10-100-3

Continued On Next Page

SAFETY & MAINTENANCE (CONT'D)

LIFTING AND BLOCKING THE EXCAVATOR	10-10-1
Procedure	10-10-1
LUBRICATING THE EXCAVATOR	10-110-1
Lubrication Locations	10-110-1
LIFTING THE EXCAVATOR	10-12-1
Procedure	10-12-1
MOTION ALARM SYSTEM (IF EQUIPPED)	10-190-1
Adjusting Switch Position	10-190-1
Description	10-190-1
Inspecting	10-190-1
OPERATOR CAB (ROPS/TOPS)	10-20-1
Cab Door	10-20-1
Description	10-20-1
Front Window	10-20-2
Front Wiper	10-20-4
Right Side Window	10-20-5
Heating, Ventilation, and Air Conditioning Duct	10-20-6
Window Washer Reservoir	10-20-4
PIVOT PINS	10-160-1
Inspection And Maintenance	10-160-1
RIGHT SIDE COVER	10-41-1
Opening And Closing The Right Side Cover	10-41-1
SEAT BELT	10-150-1
Inspection And Maintenance	10-150-1
SERVICE SCHEDULE	10-50-1
Chart	10-50-1
SPARK ARRESTOR MUFFLER	10-130-1
Cleaning Procedure	10-130-1

Continued On Next Page

Dear

**Thanks very much for your visiting and
patience.**

Want to get more information,

Please click here, Go back to the page.

**After your payment, you will have instant access to
your download.**

The Download Link will also be sent to your e-mail.

You will get the complete manual

Have any questions

please write to me

admin@servicemanualperfect.com