



# Service Manual

## 337, 341 Compact Excavator

---

**337 - S/N AAC811001 & Above**  
**337 - S/N A9W711001 & Above**  
**341 - S/N A9W911001 & Above**

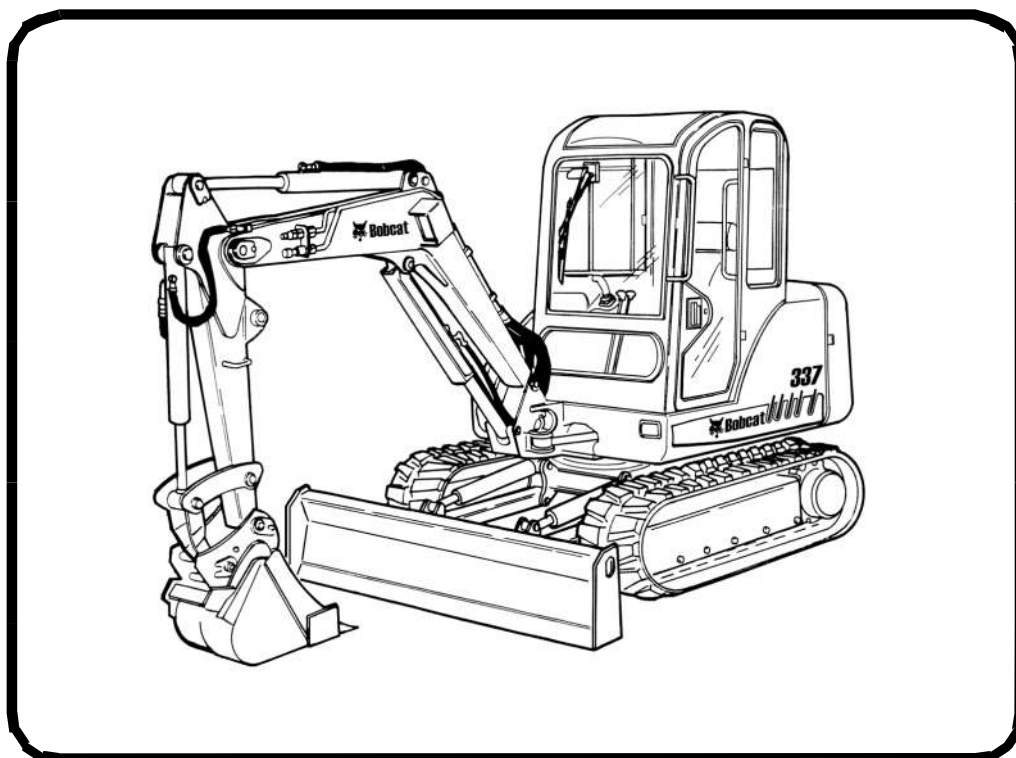



# MAINTENANCE SAFETY



## WARNING

Instructions are necessary before operating or servicing machine. Read and understand the Operation & Maintenance Manual, Operator's Handbook and signs (decals) on machine. Follow warnings and instructions in the manuals when making repairs, adjustments or servicing. Check for correct function after adjustments, repairs or service. Untrained operators and failure to follow instructions can cause injury or death.

W-2003-0807



**Safety Alert Symbol:** This symbol with a warning statement, means: "Warning, be alert! Your safety is involved!" Carefully read the message that follows.

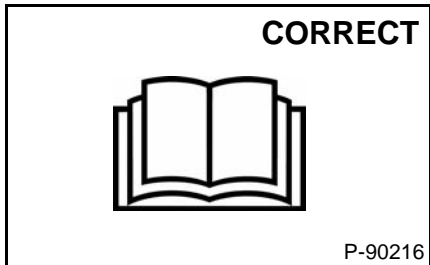

P-90216

- ⚠ Never service the Bobcat Excavator without instructions.

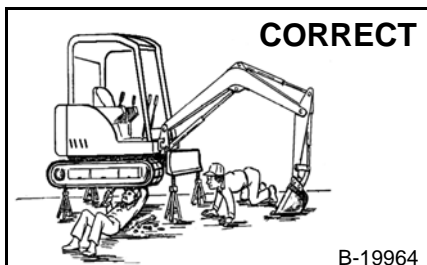

B-19964

- ⚠ Use the correct procedure to lift and support the excavator.

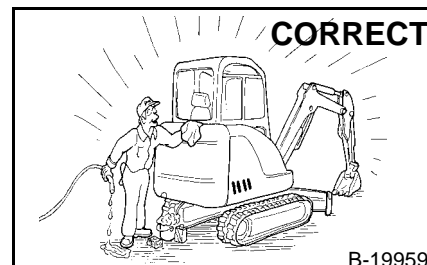

B-19959

- ⚠ Cleaning and maintenance are required daily.

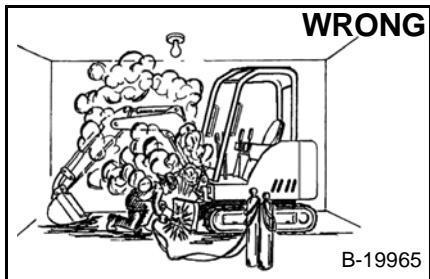

B-19965

- ⚠ Have good ventilation when welding or grinding painted parts.
- ⚠ Wear dust mask when grinding painted parts. Toxic dust and gas can be produced.

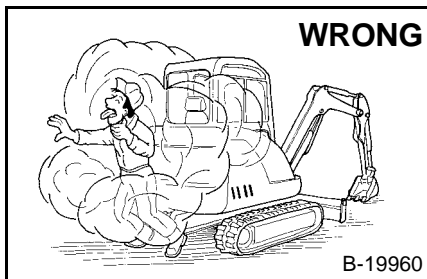

B-19960

- ⚠ Vent exhaust to outside when engine must be run for service.
- ⚠ Exhaust system must be tightly sealed. Exhaust fumes can kill without warning.

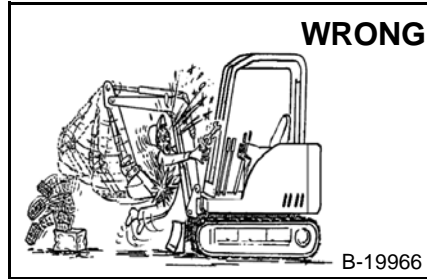

B-19966

- ⚠ Always lower the bucket and blade to the ground before doing any maintenance.
- ⚠ Never modify equipment or add attachments not approved by Bobcat Company.

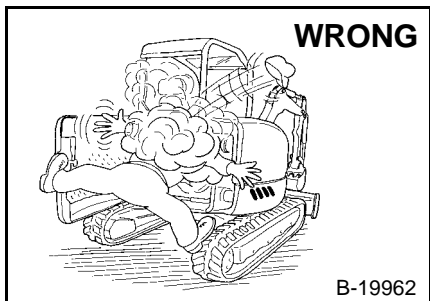

B-19962

- ⚠ Stop, cool and clean engine of flammable materials before checking fluids.
- ⚠ Never service or adjust machine with the engine running unless instructed to do so in the manual.
- ⚠ Avoid contact with leaking hydraulic fluid or diesel fuel under pressure. It can penetrate the skin or eyes.
- ⚠ Never fill fuel tank with engine running, while smoking, or when near open flame.

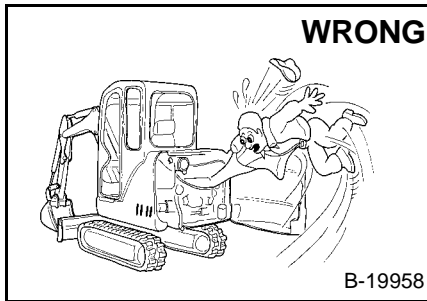

B-19958

- ⚠ Keep body, jewelry and clothing away from moving parts, electrical contact, hot parts and exhaust.
- ⚠ Wear eye protection to guard from battery acid, compressed springs, fluids under pressure and flying debris when engines are running or tools are used. Use eye protections approved for type of welding.
- ⚠ Keep tailgate closed except for service. Close and latch tailgate before operating the excavator.

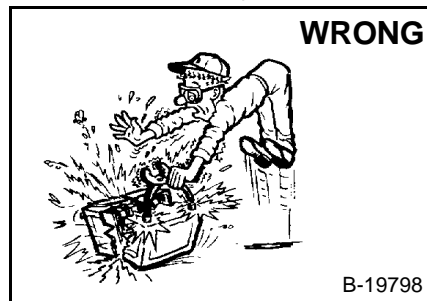

B-19798

- ⚠ Lead-acid batteries produce flammable and explosive gases.
- ⚠ Keep arcs, sparks, flames and lighted tobacco away from batteries.
- ⚠ Batteries contain acid which burns eyes or skin on contact.
- ⚠ Wear protective clothing. If acid contacts body, flush well with water. For eye contact flush well and get immediate medical attention.

Maintenance procedures which are given in the Operation & Maintenance Manual can be performed by the owner/operator without any specific technical training. Maintenance procedures which are **not** in the Operation & Maintenance Manual must be performed **ONLY BY QUALIFIED BOBCAT SERVICE PERSONNEL**. Always use genuine Bobcat replacement parts. The Service Safety Training Course is available from your Bobcat dealer.

MSW28-0409



**Bobcat®**

## ALPHABETICAL INDEX

AIR CLEANER .....	10-01, 60-01	ENGINE SPECIFICATIONS .....	SPEC-01
AIR CONDITIONING SERVICE .....	70-01	ENGINE SPEED CONTROL .....	40-01
AIR CONDITIONING SYSTEM FLOW .....	70-01	EVAPORATOR .....	70-01
ALTERNATOR .....	50-01	EVAPORATOR/HEATER UNIT .....	70-01
ANGLE BLADE .....	40-01	EXPANSION VALVE .....	70-01
ANGLE BLADE ASSEMBLY .....	40-01		
ANGLE BLADE CUTTING EDGE .....	40-01	FLOORMAT AND FLOOR PLATE .....	40-01
ANGLE BLADE CYLINDER .....	20-01	FUEL, COOLANT AND LUBRICANTS .....	SPEC-01
ANGLE BLADE VALVE .....	20-01	FUEL LEVEL SENDER .....	50-01
ARM .....	40-01	FUEL SYSTEM .....	10-01
ARM CYLINDER .....	20-01	FUEL TANK .....	40-01
BASIC TROUBLESHOOTING .....	70-01	GENERAL AIR CONDITIONING SERVICE	
BATTERY .....	50-01	GUIDELINES .....	70-01
BLADE .....	30-01		
BLADE CONTROL .....	40-01	HEATER/AC FAN .....	70-01
BLADE CYLINDER .....	20-01	HEATER AIR FILTER .....	10-01
BOOM .....	40-01	HEATER COIL .....	70-01
BOOM CYLINDER .....	20-01	HEATER VALVE .....	70-01
BOOM SWING CYLINDER .....	20-01	HORN .....	40-01
BOOM SWING LOCK VALVE .....	20-01	HYDRAULIC CONNECTION SPECIFICATIONS..	SPEC-01
BUCKET .....	40-01	HYDRAULIC CONTROL VALVE .....	20-01
BUCKET CYLINDER .....	20-01	HYDRAULIC FILTER MOUNT .....	20-01
BUILD UP VALVE .....	20-01	HYDRAULIC FLUID SPECIFICATIONS .....	SPEC-01
		HYDRAULIC PUMP .....	20-01
CAB .....	40-01	HYDRAULIC RESERVOIR .....	20-01
CASE DRAIN FILTER MOUNT .....	20-01	HYDRAULIC SYSTEM .....	10-01
CLAMP .....	40-01	HYDRAULIC SYSTEM INFORMATION .....	20-01
CLAMP CYLINDER .....	20-01	HYDRAULIC X-CHANGE VALVE .....	20-01
COMPONENTS .....	70-01		
COMPRESSOR .....	70-01	LEFT CONSOLE .....	40-01
CONDENSOR .....	70-01	LEFT CONTROL LEVER (JOYSTICK) .....	20-01
CONTROL LINKAGE ASSEMBLY .....	40-01	LIFTING AND BLOCKING THE EXCAVATOR .....	10-01
CONTROL PATTERN SELECTOR VALVE .....	20-01	LIFTING THE EXCAVATOR .....	10-01
CONVERSIONS .....	SPEC-01	LIGHTS .....	50-01
COOLING SYSTEM .....	10-01	LUBRICATION OF THE EXCAVATOR .....	10-01
CROSSPORT RELIEF VALVE .....	20-01		
		MAIN RELIEF VALVE .....	20-01
DELUXE INSTRUMENT PANEL SETUP .....	50-01	MANIFOLD ASSEMBLY/ACCUMULATOR .....	20-01
DIAGNOSTICS SERVICE CODE .....	50-01	MUFFLER .....	60-01
DIRECT TO TANK VALVE .....	20-01		
DUAL SEQUENCE VALVE .....	20-01	OIL COOLER .....	20-01
		OPERATOR CAB .....	10-01
ELECTRICAL SYSTEM INFORMATION .....	50-01		
ENGINE .....	60-01	PORT RELIEF VALVES .....	20-01
ENGINE ACCESSORY DRIVE BELT .....	10-01	PRESSURE REDUCING VALVE .....	20-01
ENGINE COMPONENTS AND TESTING .....	60-01	PRESSURE RELIEF VALVE .....	70-01
ENGINE FLYWHEEL .....	60-01	PRESSURE SWITCH .....	70-01
ENGINE LUBRICATION SYSTEM .....	10-01		

Continued On Next Page

## ALPHABETICAL INDEX (CONT'D)

RADIATOR.....	60-01	TAILGATE.....	10-01, 40-01
RECEIVER/DRYER.....	70-01	TEMPERATURE/PRESSURE.....	70-01
RECONDITIONING THE ENGINE .....	60-01	THERMOSTAT .....	70-01
REGULAR MAINTENANCE .....	70-01	TORQUE SPECIFICATIONS .....	SPEC-01
REMOVING AIR FROM HYDRAULIC SYSTEM .....	20-01	TRACK DAMAGE IDENTIFICATION .....	30-01
RIGHT CONSOLE .....	40-01	TRACK FRAME .....	30-01
RIGHT CONTROL LEVER (JOYSTICK) .....	20-01	TRACK IDLER.....	30-01
RIGHT PEDAL AND LINKAGE.....	40-01	TRACK ROLLER.....	30-01
RIGHT SIDE COVER .....	10-01	TRACKS.....	30-01
ROPS CANOPY.....	40-01	TRANSPORTING THE EXCAVATOR .....	10-01
 		TRAVEL CONTROLS.....	40-01
SAFETY.....	70-01	TRAVEL CONTROL VALVE .....	20-01
SEAT AND SEAT MOUNT .....	40-01	TRAVEL MOTOR .....	10-01, 20-01
SEAT BELT .....	10-01	TROUBLESHOOTING .....	60-01
SERVICE SCHEDULE .....	10-01	TWO SPEED SWITCH.....	50-01
SPARK ARRESTOR MUFFLER .....	10-01	 	
SPECIFICATIONS .....	SPEC-01	UPPERSTRUCTURE.....	40-01
STARTER .....	50-01	 	
SWING CIRCLE GEAR .....	30-01	X-CHANGE .....	40-01
SWING FRAME.....	40-01	X-CHANGE (HYDRAULIC) .....	40-01
SWING MOTOR .....	20-01		
SWING MOTOR DRIVE CARRIER .....	20-01		
SWIVEL JOINT .....	20-01		
SYSTEM CHARGING AND RECLAMATION .....	70-01		
SYSTEM TROUBLESHOOTING CHART .....	70-01		

## CONTENTS

FOREWORD.....	III
SAFETY INSTRUCTIONS .....	V
FIRE PREVENTION .....	VII
SERIAL NUMBER LOCATIONS .....	IX
DELIVERY REPORT.....	X
BOBCAT EXCAVATOR IDENTIFICATION .....	XI
SAFETY AND MAINTENANCE.....	10-01
HYDRAULIC SYSTEM .....	20-01
UNDERCARRIAGE.....	30-01
UPPERSTRUCTURE & SWING SECTION .....	40-01
ELECTRICAL SYSTEM AND ANALYSIS .....	50-01
ENGINE SERVICE .....	60-01
HEATING, VENTILATION, AIR CONDITIONING .....	70-01
SPECIFICATIONS.....	SPEC-01

**SAFETY AND  
MAINTENANCE**

**HYDRAULIC  
SYSTEM**

**UNDERCARRIAGE**

**UPPERSTRUCTURE  
& SWING  
SECTION**

**ELECTRICAL  
SYSTEM AND  
ANALYSIS**

**ENGINE  
SERVICE**

**HVAC**

**SPECIFICATIONS**









**Bobcat®**

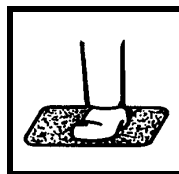
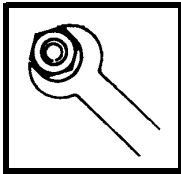
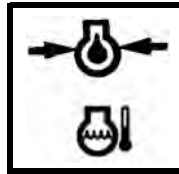
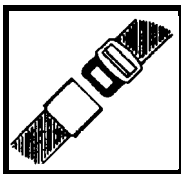
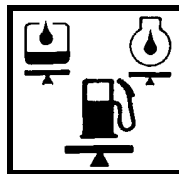

# FOREWORD

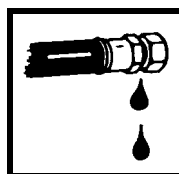
This manual is for the Bobcat excavator mechanic. It provides necessary servicing and adjustment procedures for the Bobcat excavator and its component parts and systems. Refer to the Operation & Maintenance Manual for operating instructions, starting procedure, daily checks, etc.

A general inspection of the following items must be made after the excavator has had service or repair:

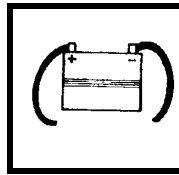
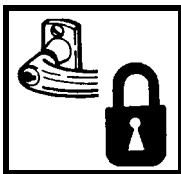
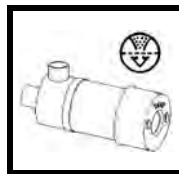
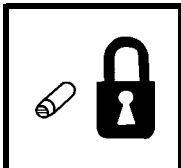
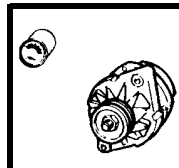
- |   |   |  |   |
|---|---|--|---|
| 1. Check that the ROPS/TOPS/FOPS is in good condition and is not modified.  |    | 9. Safety treads must be in good condition.  |    |
| 2. Check that ROPS/TOPS mounting hardware is tightened and is Bobcat approved.  |    | 10. Check for correct function of indicator lamps.                                   |    |
| 3. The seat belt must be correctly installed, functional and in good condition.   |    | 11. Check hydraulic fluid level, engine oil level and fuel supply.                   |    |
| 4. Machine signs (decals) must be legible and in the correct location.  |   | 12. Inspect for fuel, oil or hydraulic fluid leaks.                                  |   |
| 5. Travel levers, control levers and foot pedals must return to neutral. Check that the pedal locks are in working order. |  | 13. Lubricate the excavator.   |  |
| 6. Check for correct function of the work lights.   |  | 14. Check the condition of the battery and cables.                                   |  |
| 7. Enclosure door latches must open and close freely.   |  | 15. Inspect the air cleaner for damage or leaks. Check the condition of the element. |  |
| 8. Attachment locking pins must function correctly and be in good condition.  |  | 16. Check the electrical charging system.  |  |

FW EXC-0509 SM

17. Check tracks for wear and tension. Use only approved tracks.

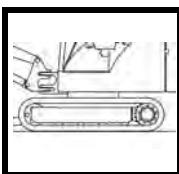

18. Inspect for loose or broken parts or connections.



19. Check for any field modification not completed.



20. Operate the machine and check all functions.



21. Check the control console interlocks for correct function.

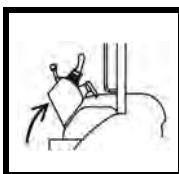

22. Inspect the X-Change™ for wear or damage. Repair or replace damaged parts.

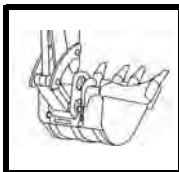

23. Check function or condition of all equipped options and accessories (examples: special applications kit, motion alarm, etc.).



24. Recommend to the owner that all necessary corrections be made before the machine is returned to service.

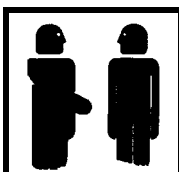

**CALIFORNIA  
PROPOSITION 65 WARNING**  
Diesel engine exhaust and some of its constituents are known to the state of California to cause cancer, birth defects and other reproductive harm.

## SAFETY INSTRUCTIONS



### Safety Alert Symbol

This symbol with a warning statement means: "Warning, be alert! Your safety is involved!" Carefully read the message that follows.



## WARNING

Instructions are necessary before operating or servicing machine. Read and understand the Operation & Maintenance Manual, Operator's Handbook and signs (decals) on machine. Follow warnings and instructions in the manuals when making repairs, adjustments or servicing. Check for correct function after adjustments, repairs or service. Untrained operators and failure to follow instructions can cause injury or death.

W-2003-0903

## IMPORTANT

This notice identifies procedures which must be followed to avoid damage to the machine.

I-2019-0284



## DANGER

The signal word DANGER on the machine and in the manuals indicates a hazardous situation which, if not avoided, will result in death or serious injury.

D-1002-1107



## WARNING

The signal word WARNING on the machine and in the manuals indicates a potentially hazardous situation which, if not avoided, could result in death or serious injury.

W-2044-1107

The following publications provide information on the safe use and maintenance of the Bobcat machine and attachments:

- The Delivery Report is used to assure that complete instructions have been given to the new owner and that the machine is in safe operating condition.
- The Operation & Maintenance Manual delivered with the machine or attachment contains operating information as well as routine maintenance and service procedures. It is a part of the machine and can be stored in a container provided on the machine. Replacement Operation & Maintenance Manuals can be ordered from your Bobcat dealer.
- Machine signs (decals) instruct on the safe operation and care of your Bobcat machine or attachment. The signs and their locations are shown in the Operation & Maintenance Manual. Replacement signs are available from your Bobcat dealer.
- An Operator's Handbook fastened to the operator cab. It's brief instructions are convenient to the operator. The handbook is available from your dealer in an English edition or one of many other languages. See your Bobcat dealer for more information on translated versions.
- The AEM Safety Manual delivered with the machine gives general safety information.
- The Service Manual and Parts Manual are available from your dealer for use by mechanics to do shop-type service and repair work.
- The Compact Excavator Operator Training Course is available through your local dealer or at [www.training.bobcat.com](http://www.training.bobcat.com) or [www.bobcat.com](http://www.bobcat.com). This course is intended to provide rules and practices of correct operation of the Bobcat excavator. The course is available in English and Spanish versions.
- Service Safety Training Courses are available from your Bobcat dealer or at [www.training.bobcat.com](http://www.training.bobcat.com) or [www.bobcat.com](http://www.bobcat.com). They provide information for safe and correct service procedures.
- The Bobcat compact excavator Safety Video is available from your Bobcat dealer or at [www.training.bobcat.com](http://www.training.bobcat.com) or [www.bobcat.com](http://www.bobcat.com).

SI EXC-0308 SM

## SAFETY INSTRUCTIONS (CONT'D)

The dealer and owner / operator review the recommended uses of the product when delivered. If the owner / operator will be using the machine for a different application(s) he or she must ask the dealer for recommendations on the new use.



Cutting or drilling concrete containing sand or rock containing quartz may result in exposure to silica dust. Do not exceed Permissible Exposure Limits (PEL) to silica dust as determined by OSHA or other job site Rules and Regulations. Use a respirator, water spray or other means to control dust. Silica dust can cause lung disease and is known to the state of California to cause cancer.

**Call Before You Dig**  
**Dial 811 (USA Only)**  
**1-888-258-0808 (USA & Canada)**

When you call, you will be directed to a location in your state / province, or city for information about buried lines (telephone, cable TV, water, sewer, gas, etc.).

## FIRE PREVENTION



### Maintenance

The machine and some attachments have components that are at high temperatures under normal operating conditions. The primary source of high temperatures is the engine and exhaust system. The electrical system, if damaged or incorrectly maintained, can be a source of arcs or sparks.

Flammable debris (leaves, straw, etc.) must be removed regularly. If flammable debris is allowed to accumulate, it can cause a fire hazard. Clean often to avoid this accumulation. Flammable debris in the engine compartment is a potential fire hazard.

The operator's area, engine compartment and engine cooling system must be inspected every day and cleaned if necessary to prevent fire hazards and overheating.

All fuels, most lubricants and some coolants mixtures are flammable. Flammable fluids that are leaking or spilled onto hot surfaces or onto electrical components can cause a fire.

### Operation

Do not use the machine where exhaust, arcs, sparks or hot components can contact flammable material, explosive dust or gases.

### Electrical



Check all electrical wiring and connections for damage. Keep the battery terminals clean and tight. Repair or replace any damaged part or wires that are loose or frayed.

Battery gas can explode and cause serious injury. Use the procedure in the Operation & Maintenance Manual for connecting the battery and for jump starting. Do not jump start or charge a frozen or damaged battery. Keep any open flames or sparks away from batteries. Do not smoke in battery charging area.

## Hydraulic System

Check hydraulic tubes, hoses and fittings for damage and leakage. Never use open flame or bare skin to check for leaks. Hydraulic tubes and hoses must be properly routed and have adequate support and secure clamps. Tighten or replace any parts that show leakage.

Always clean fluid spills. Do not use gasoline or diesel fuel for cleaning parts. Use commercial nonflammable solvents.

### Fueling



Stop the engine and let it cool before adding fuel. No smoking! Do not refuel a machine near open flames or sparks. Fill the fuel tank outdoors.

### Starting

Do not use ether or starting fluids on any engine that has glow plugs. These starting aids can cause explosion and injure you or bystanders.

Use the procedure in the Operation & Maintenance Manual for connecting the battery and for jump starting.

## Spark Arrestor Exhaust System

The spark arrestor exhaust system is designed to control the emission of hot particles from the engine and exhaust system, but the muffler and the exhaust gases are still hot.

Check the spark arrestor exhaust system regularly to make sure it is maintained and working properly. Use the procedure in the Operation & Maintenance Manual for cleaning the spark arrestor muffler (if equipped).

## **FIRE PREVENTION (CONT'D)**

### **Welding And Grinding**

Always clean the machine and attachment, disconnect the battery, and disconnect the wiring from the Bobcat controllers before welding. Cover rubber hoses, battery and all other flammable parts. Keep a fire extinguisher near the machine when welding.

Have good ventilation when grinding or welding painted parts. Wear dust mask when grinding painted parts. Toxic dust or gas can be produced.

Dust generated from repairing nonmetallic parts such as hoods, fenders or covers can be flammable or explosive. Repair such components in a well ventilated area away from open flames or sparks.

### **Fire Extinguishers**

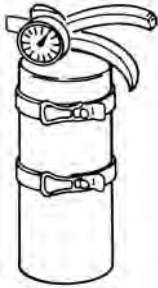

Know where fire extinguishers and first aid kits are located and how to use them. Inspect the fire extinguisher and service the fire extinguisher regularly. Obey the recommendations on the instructions plate.

## SERIAL NUMBER LOCATIONS

Always use the serial number of the excavator when requesting service information or when ordering parts. Early or later models (identification made by serial number) may use different parts, or it may be necessary to use a different procedure in doing a specific service operation.

### Excavator Serial Number

Figure 1

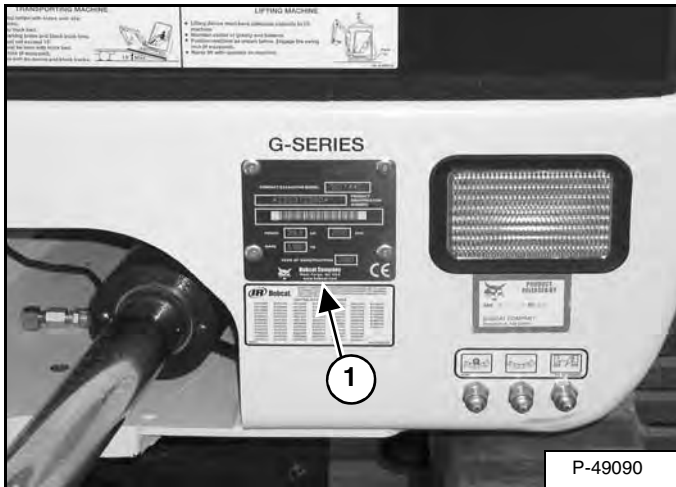

The excavator serial number plate (Item 1) [Figure 1] is located on the frame of the machine in the location shown.

Explanation of Excavator Serial Number:

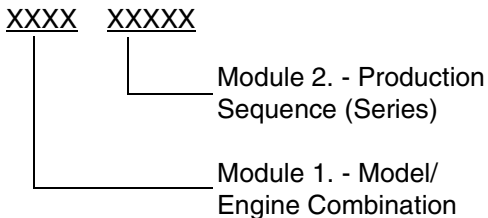

1. The 4 digit Model/Engine Combination Module number identifies the model number and engine combination.
2. The 5 digit Production Sequence Number identifies the order which the excavator is produced.

### Engine Serial Number

Figure 2

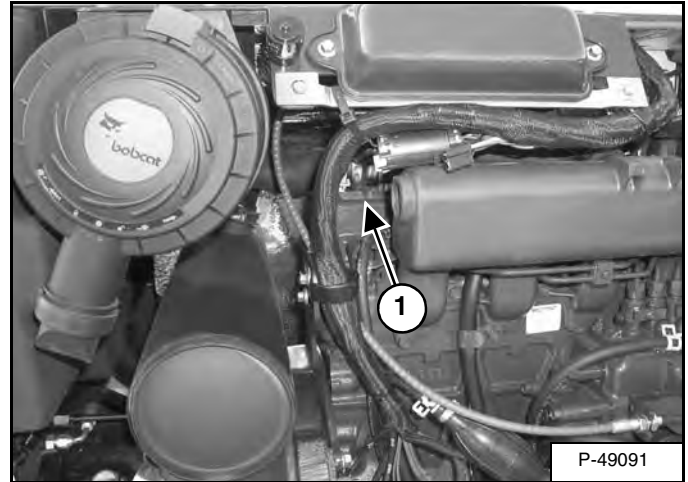
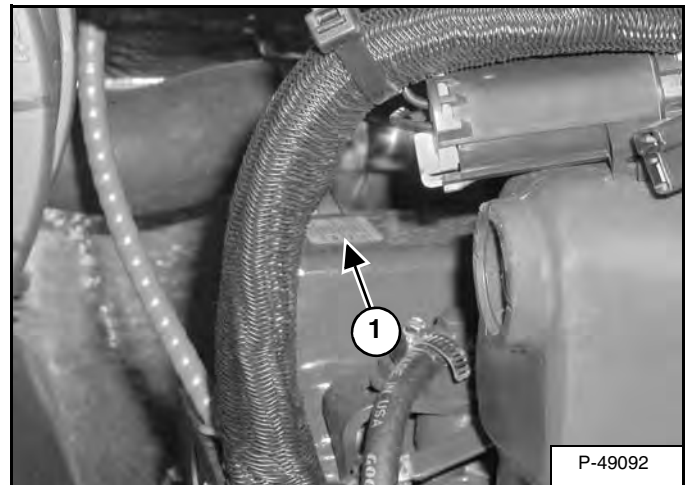

Figure 3



The engine serial number (Item 1) [Figure 2] & [Figure 3] is located on the engine in the location shown.

## DELIVERY REPORT

Figure 4

The diagram shows a form layout for a delivery report. It includes a title 'DELIVERY REPORT', a 'WARNING' section, and a reference code 'B-16315'.

The delivery report must be filled out by the dealer and signed by the owner or operator when the Bobcat Excavator is delivered. An explanation of the form must be given to the owner. Make sure it is filled out completely **[Figure 4]**.



**BOBCAT EXCAVATOR IDENTIFICATION**

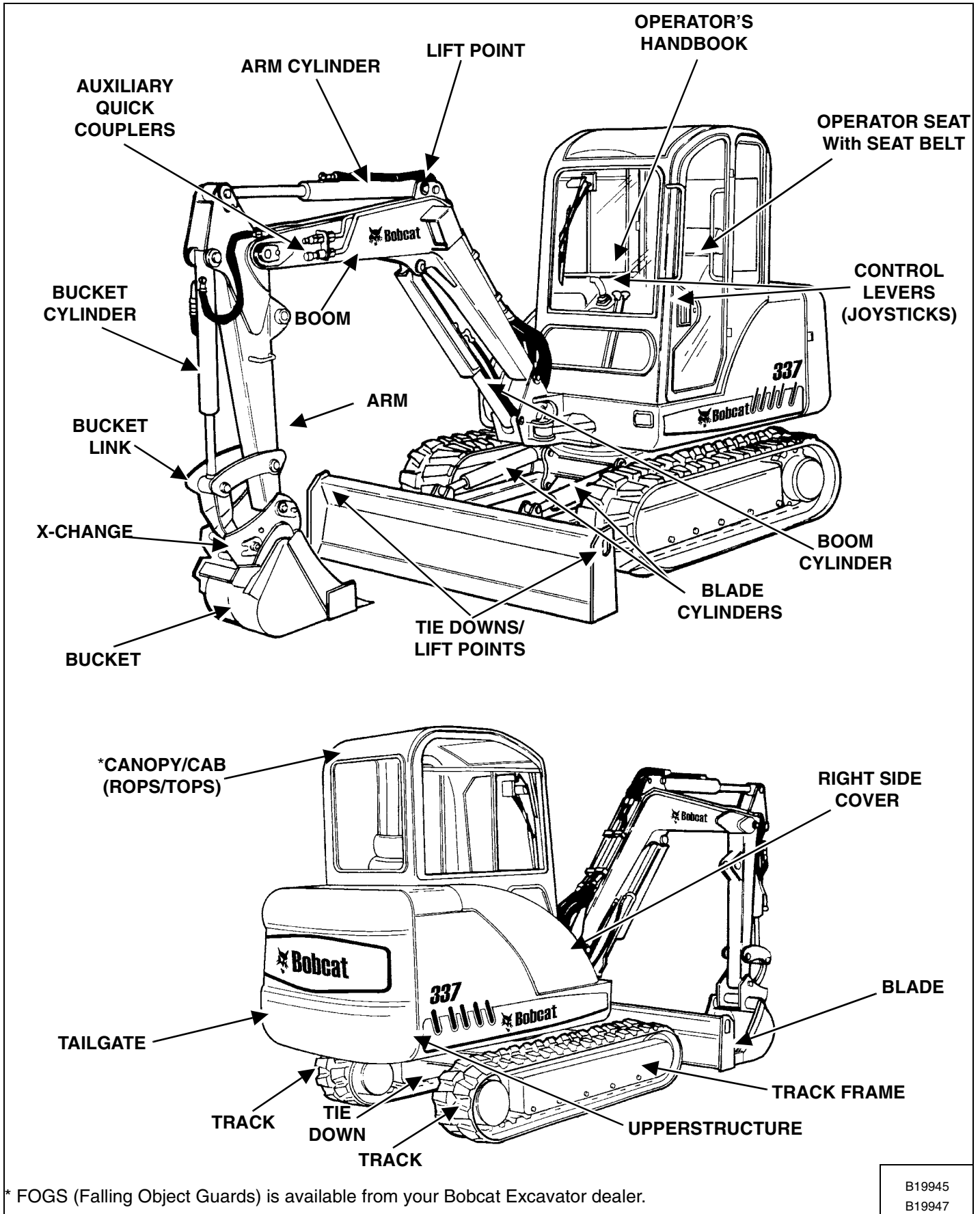

\* FOGS (Falling Object Guards) is available from your Bobcat Excavator dealer.

B19945  
B19947



**Bobcat®**

**Dear**

**Thanks very much for your visiting and  
patience.**

**Want to get more information,**

**Please click here, Go back to the page.**

**After your payment, you will have instant access to  
your download.**

**The Download Link will also be sent to your e-mail.**

**You will get the complete manual**

**Have any questions**

**please write to me**

**[admin@servicemanualperfect.com](mailto:admin@servicemanualperfect.com)**