



Bobcat®

Service Manual

A300 All-Wheel Steer

S/N 539911001 & Above
S/N 540011001 & Above

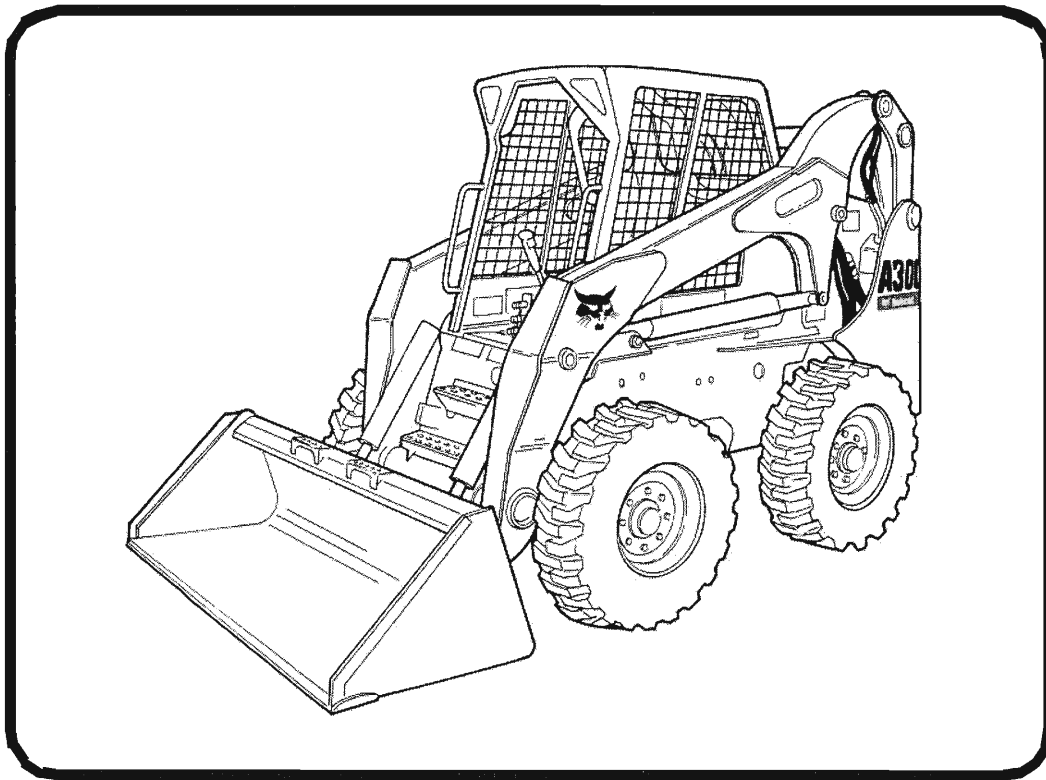

**EQUIPPED WITH
BOBCAT INTERLOCK
CONTROL SYSTEM (BICS™)**



MAINTENANCE SAFETY



WARNING

Instructions are necessary before operating or servicing machine. Read and understand the Operation & Maintenance Manual, Operator's Handbook and signs (decals) on machine. Follow warnings and instructions in the manuals when making repairs, adjustments or servicing. Check for correct function after adjustments, repairs or service. Untrained operators and failure to follow instructions can cause injury or death.

W-2003-0903



Safety Alert Symbol: This symbol with a warning statement, means: "Warning, be alert! Your safety is involved!" Carefully read the message that follows.

CORRECT



B-10731a

- ⚠ Never service the Bobcat Skid-Steer Loader without instructions.

CORRECT



B-16261

- ⚠ Use the correct procedure to lift or lower operator cab.

CORRECT

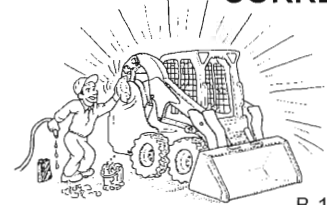

B-16264

- ⚠ Cleaning and maintenance are required daily.

WRONG



B-16272

- ⚠ Have good ventilation when welding or grinding painted parts.
- ⚠ Wear dust mask when grinding painted parts. Toxic dust and gas can be produced.
- ⚠ Avoid exhaust fume leaks which can kill without warning. Exhaust system must be tightly sealed.

WRONG



B-16260

- ⚠ Disconnecting or loosening any hydraulic tubeline, hose, fitting, component or a part failure can cause lift arms to drop. Do not go under lift arms when raised unless supported by an approved lift arm support device. Replace it if damaged.

WRONG

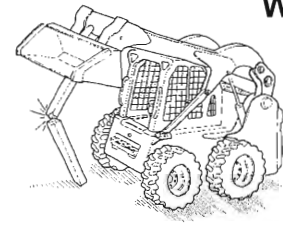

B-16263

- ⚠ Never work on loader with lift arms up unless lift arms are held by an approved lift arm support device. Replace if damaged.
- ⚠ Never modify equipment or add attachments not approved by Bobcat Company.

WRONG



B-16271

- ⚠ Stop, cool and clean engine of flammable materials before checking fluids.
- ⚠ Never service or adjust loader with the engine running unless instructed to do so in the manual.
- ⚠ Avoid contact with leaking hydraulic fluid or diesel fuel under pressure. It can penetrate the skin or eyes.
- ⚠ Never fill fuel tank with engine running, while smoking or when near open flame.

WRONG

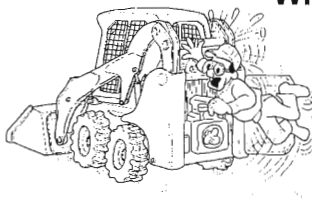

B-16270

- ⚠ Keep body, jewelry and clothing away from moving parts, electrical contact, hot parts and exhaust.
- ⚠ Wear eye protection to guard from battery acid, compressed springs, fluids under pressure and flying debris when engines are running or tools are used. Use eye protection approved for type of welding.
- ⚠ Keep rear door closed except for service. Close and latch door before operating the loader.

WRONG



B-6589

- ⚠ Lead-acid batteries produce flammable and explosive gases.
- ⚠ Keep arcs, sparks, flames and lighted tobacco away from batteries.
- ⚠ Batteries contain acid which burns eyes or skin on contact. Wear protective clothing. If acid contacts body, flush well with water. For eye contact flush well and get immediate medical attention.

Maintenance procedures which are given in the Operation & Maintenance Manual can be performed by the owner/operator without any specific technical training. Maintenance procedures which are **not** in the Operation & Maintenance Manual must be performed **ONLY BY QUALIFIED BOBCAT SERVICE PERSONNEL**. Always use **genuine Bobcat replacement parts**. The Service Safety Training Course is available from your Bobcat dealer.

MSW14-0805



Bobcat®

ALPHABETICAL INDEX

ACCESS PANEL (INSIDE)	50-01	FRONT AUXILIARY HYDRUALIC COUPLER	
AIR CLEANER	70-01	BLOCK	20-01
AIR CLEANER SERVICE	10-01	FUEL SYSTEM	10-01, 70-01
AIR CONDITIONING SYSTEM FLOW	80-01	FUEL TANK	50-01
ALTERNATOR	60-01		
		HEATER COIL	80-01
BATTERY	60-01	HEATER VALVE	80-01
BLOWER FAN	80-01	HIGH FLOW VALVE	20-01
BOBCAT CONTROLLER (AWS).....	60-01	HUB	40-01
BOBCAT CONTROLLER (AWS) (SJC)		HYDRAULIC CONNECTION SPECS	SPEC-01
(DRIVE PLUS)	60-01	HYDRAULIC CONTROL VALVE	20-01
BOBCAT CONTROLLER (MAIN).....	60-01	HYDRAULIC FLUID RESERVOIR	20-01
BOBCAT INTERLOCK CONTROL		HYDRAULIC/HYDROSTATIC FILTERS	20-01
SYSTEM (BICS)	60-01	HYDRAULIC/HYDROSTATIC FLUID	
BOB-TACH (HAND LEVER)	10-01, 50-01	SPECIFICATIONS	SPEC-01
BOB-TACH (POWER - OPTION)	10-01, 50-01	HYDRAULIC/HYDROSTATIC SYSTEM	10-01
BOB-TACH (POWER) BLOCK.....	20-01	HYDRAULIC PUMP	20-01
BRAKE	40-01	HYDRAULIC PUMP (HI FLOW)	20-01
BUCKET POSITION VALVE	20-01	HYDRAULIC SYSTEM INFORMATION	20-01
		HYDROSTATIC MOTOR	30-01
CAB DOOR.....	50-01	HYDROSTATIC MOTOR (TWO-SPEED)	30-01
CALIBRATION	60-01	HYDROSTATIC MOTOR CARRIER	30-01
CAMSHAFT AND TIMING GEARS.....	70-01	HYDROSTATIC PUMP	30-01
CASE DRAIN FILTER	30-01	HYDROSTATIC SYSTEM INFORMATION	30-01
CHAINCASE	40-01		
CHARGE PRESSURE	30-01	INSTRUMENT PANEL.....	60-01
COMPRESSOR	80-01		
CONDENSER	80-01	JOYSTICK CONTROL	50-01
CONTROL PANEL	50-01		
CONTROL PANEL SETUP	60-01	LIFT ARMS.....	50-01
CONVERSIONS	SPEC-01	LIFT ARM BY-PASS CONTROL VALVE	20-01
CRANKSHAFT AND PISTONS.....	70-01	LIFT ARM SUPPORT DEVICE	10-01
CYLINDER HEAD	70-01	LIFTING AND BLOCKING THE LOADER.....	10-01
CYLINDER (BOB-TACH)	20-01	LIGHTS	60-01
CYLINDER (LIFT).....	20-01	A300 LOADER SPECIFICATIONS.....	SPEC-01
CYLINDER (STEERING).....	20-01	LOADER STORAGE & RETURN TO SERVICE	10-01
CYLINDER (TILT)	20-01	LUBRICATION SYSTEM	70-01
		LUBRICATING THE LOADER.....	10-01
DIAGNOSTICS SERVICE CODES	60-01	MAIN RELIEF VALVE	20-01
DRIVE BELT	30-01	MUFFLER.....	70-01
DRIVE COMPONENTS	40-01		
		OIL COOLER.....	20-01
ELECTRICAL / HYDRAULIC CONTROLS		OPERATOR CAB	10-01, 50-01
REFERENCE	60-01	OPERATOR SEAT (SUSPENSION).....	50-01
ELECTRICAL SYSTEM INFORMATION	60-01		
ENGINE COOLING SYSTEM	10-01, 70-01	PASSWORD SETUP (IF EQUIPPED WITH KEYLESS	
ENGINE INFORMATION	70-01	START).....	60-01
ENGINE LUBRICATION SYSTEM.....	10-01	PIVOT PINS	10-01
ENGINE SPEED CONTROL	70-01		
EVAPORATOR.....	80-01	REAR AUXILIARY DIVERTER VALVE.....	20-01
EVAPORATOR/HEATER UNIT	80-01	REAR DOOR	50-01
EXPANSION VALVE	80-01	REAR GRILL	50-01
		RECEIVER/DRIER.....	80-01
FINAL DRIVE TRANSMISSION (CHAINCASE) ..	10-01	REGULAR MAINTENANCE	80-01
FLYWHEEL AND HOUSING	70-01	REMOTE START TOOL	10-01
FLYWHEEL RPM SENSOR	60-01	REMOTE START TOOL (SERVICE TOOL)	10-01

ALPHABETICAL INDEX (CONT'D)

SEAT BAR	50-01
SEAT BAR SENSOR	60-01
SERVICE PC (LAPTOP COMPUTER)	60-01
SERVICE SCHEDULE	10-01
SPARK ARRESTOR MUFFLER	10-01
SPEED SENSOR	60-01
STOPPING THE ENGINE AND LEAVING THE LOADER	10-01
STARTER	60-01
STEERING BLOCK	40-01
STEERING DRIFT COMPENSATION	60-01
STEERING SOLENOIDS	60-01
SYSTEM CHARGING AND RECLAMATION	80-01
THERMOSTAT	80-01
TIRE MAINTENANCE	10-01
TORQUE SPECIFICATIONS FOR BOLTS SPEC-01	
TOWING THE LOADER	10-01
TRACTION LOCK	60-01
TRANSPORTING THE LOADER ON A TRAILER ..	10-01
TROUBLESHOOTING	70-01
TURBOCHARGER	80-01
WHEEL POSITION SENSORS	60-01
WINDOW (FRONT DOOR)	50-01
WINDOW (REAR)	50-01
WINDOW (SIDE)	50-01
WINDOW (TOP)	50-01

CONTENTS

FOREWORD.....	II
SAFETY INSTRUCTIONS	V
SERIAL NUMBER LOCATIONS	IX
DELIVERY REPORT.....	X
LOADER IDENTIFICATION	XI
SAFETY AND MAINTENANCE.....	10-01
HYDRAULIC SYSTEM	20-01
HYDROSTATIC SYSTEM	30-01
DRIVE SYSTEM	40-01
MAIN FRAME	50-01
ELECTRICAL SYSTEM & ANALYSIS.....	60-01
ENGINE SERVICE	70-01
HEATING, VENTILATION, AIR CONDITIONING	80-01
SPECIFICATIONS.....	SPEC-01

**SAFETY &
MAINTENANCE**

**HYDRAULIC
SYSTEM**

**HYDROSTATIC
SYSTEM**

**DRIVE
SYSTEM**

MAIN FRAME

**ELECTRICAL
SYSTEM &
ANALYSIS**

**ENGINE
SERVICE**

HVAC

SPECIFICATIONS

FOREWORD

This manual is for the Bobcat loader mechanic. It provides necessary servicing and adjustment procedures for the Bobcat loader and its component parts and systems. Refer to the Operation & Maintenance Manual for operating instructions, starting procedure, daily checks, etc.

A general inspection of the following items must be made after the loader has had service or repair:

1. Check that the ROPS/FOPS (Including side screens) is in good condition and is not modified.

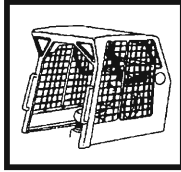

2. Check that ROPS mounting hardware is tightened and is Bobcat approved.



3. The seat belt must be correctly installed, functional and in good condition.

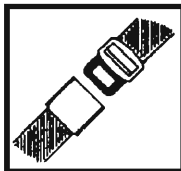

4. The seat bar must be correctly adjusted, clean and lubricated.

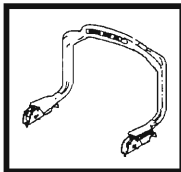

5. Check lift arm support device, replace if damaged.

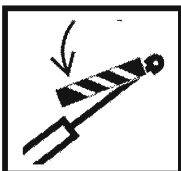

6. Machine signs (decals) must be legible and in the correct location.



7. Steering levers, hand controls and foot pedals must return to neutral (as applicable).

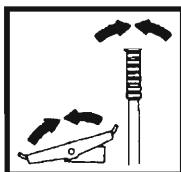

8. Check for correct function of the work lights.



9. The parking brake must function correctly.



10. Enclosure door latches must open and close freely.

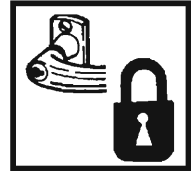

11. Bob-Tach wedges and linkages must function correctly and be in good condition.

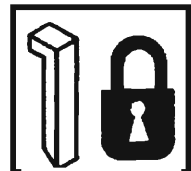

12. Safety treads must be in good condition.

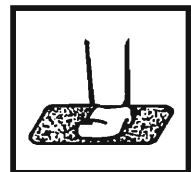

13. Check for correct function of indicator lamps.

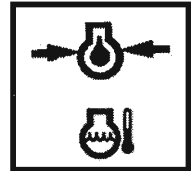

14. Check hydraulic fluid level, engine oil level and fuel supply.

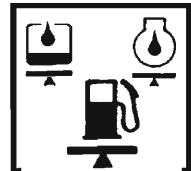

15. Inspect for fuel, oil or hydraulic fluid leaks.

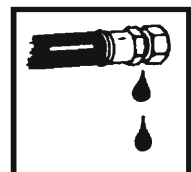

16. Lubricate the loader.



FW SSL-1008 SM

17. Check the condition of the battery and cables.

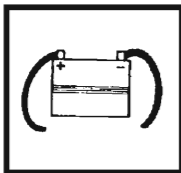

23. Operate the machine and check all functions.

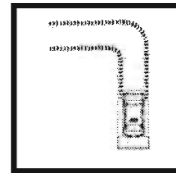

18. Inspect the air cleaner for damage or leaks. Check the condition of the element.

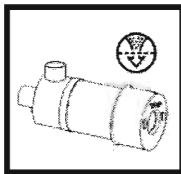

24. Check for correct function of the Bobcat Interlock Control System (BICS™) before the machine is returned to the customer.



19. Check the electrical charging system.

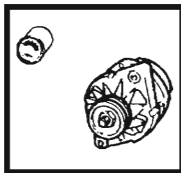

25. Check for proper function of front horn and back-up alarm (if equipped).



20. Check tires for wear and pressure. Check tracks for wear and tension. Use only approved tires or tracks.

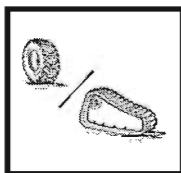

26. Check function or condition of all equipped options and accessories (examples: fire extinguisher, rotating beacon, lift kits, etc.).



21. Inspect for loose or broken parts or connections.

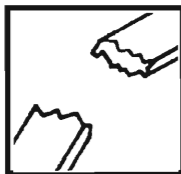

27. Recommend to the owner that all necessary corrections be made before the machine is returned to service.

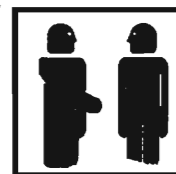

22. Check for any field modification not completed.



**CALIFORNIA
PROPOSITION 65 WARNING**
Diesel engine exhaust and some of its constituents are known to the state of California to cause cancer, birth defects and other reproductive harm.



Bobcat®

FW SSL-1008 SM

SAFETY INSTRUCTIONS



Safety Alert Symbol

This symbol with a warning statement means:
"Warning, be alert! Your safety is involved!"
Carefully read the message that follows.



WARNING

Instructions are necessary before operating or servicing machine. Read and understand the Operation & Maintenance Manual, Operator's Handbook and signs (decals) on machine. Follow warnings and instructions in the manuals when making repairs, adjustments or servicing. Check for correct function after adjustments, repairs or service. Untrained operators and failure to follow instructions can cause injury or death.

W-2003-0903

IMPORTANT

This notice identifies procedures which must be followed to avoid damage to the machine.

I-2019-0284



DANGER

The signal word DANGER on the machine and in the manuals indicates a hazardous situation which, if not avoided, will result in death or serious injury.

D-1002-1107



WARNING

The signal word WARNING on the machine and in the manuals indicates a potentially hazardous situation which, if not avoided, could result in death or serious injury.

W-2044-1107

The following publications provide information on the safe use and maintenance of the Bobcat machine and attachments:

- The Delivery Report is used to assure that complete instructions have been given to the new owner and that the machine is in safe operating condition.
- The Operation & Maintenance Manual delivered with the machine or attachment contains operating information as well as routine maintenance and service procedures. It is a part of the machine and can be stored in a container provided on the machine. Replacement Operation & Maintenance Manuals can be ordered from your Bobcat dealer.
- Machine signs (decals) instruct on the safe operation and care of your Bobcat machine or attachment. The signs and their locations are shown in the Operation & Maintenance Manual. Replacement signs are available from your Bobcat dealer.
- An Operator's Handbook fastened to the operator cab. It's brief instructions are convenient to the operator. The handbook is available from your dealer in an English edition or one of many other languages. See your Bobcat dealer for more information on translated versions.
- The AEM Safety Manual delivered with the machine gives general safety information.
- The Service Manual and Parts Manual are available from your dealer for use by mechanics to do shop-type service and repair work.
- The Skid-Steer Loader Operator Training Course is available through your local dealer or at www.training.bobcat.com or www.bobcat.com. This course is intended to provide rules and practices of correct operation of the Skid-Steer Loader. The course is available in English and Spanish versions.
- Service Safety Training Courses are available from your Bobcat dealer or at www.training.bobcat.com or www.bobcat.com. They provide information for safe and correct service procedures.
- The Skid-Steer Loader Safety Video is available from your Bobcat dealer or at www.training.bobcat.com or www.bobcat.com.

SI SSL-1008 SM

SAFETY INSTRUCTIONS (CONT'D)

The dealer and owner / operator review the recommended uses of the product when delivered. If the owner / operator will be using the machine for a different application(s) he or she must ask the dealer for recommendations on the new use.



Cutting or drilling concrete containing sand or rock containing quartz may result in exposure to silica dust. Do not exceed Permissible Exposure Limits (PEL) to silica dust as determined by OSHA or other job site Rules and Regulations. Use a respirator, water spray or other means to control dust. Silica dust can cause lung disease and is known to the state of California to cause cancer.

Call Before You Dig
Dial 811 (USA Only)
1-888-258-0808 (USA & Canada)

When you call, you will be directed to a location in your state / province, or city for information about buried lines (telephone, cable TV, water, sewer, gas, etc.).

SI SSL-1008 SM

FIRE PREVENTION



Maintenance

The machine and some attachments have components that are at high temperatures under normal operating conditions. The primary source of high temperatures is the engine and exhaust system. The electrical system, if damaged or incorrectly maintained, can be a source of arcs or sparks.

Flammable debris (leaves, straw, etc.) must be removed regularly. If flammable debris is allowed to accumulate, it can cause a fire hazard. Clean often to avoid this accumulation. Flammable debris in the engine compartment is a potential fire hazard.

The operator's area, engine compartment and engine cooling system must be inspected every day and cleaned if necessary to prevent fire hazards and overheating.

All fuels, most lubricants and some coolants mixtures are flammable. Flammable fluids that are leaking or spilled onto hot surfaces or onto electrical components can cause a fire.

Operation

Do not use the machine where exhaust, arcs, sparks or hot components can contact flammable material, explosive dust or gases.

Electrical



Check all electrical wiring and connections for damage. Keep the battery terminals clean and tight. Repair or replace any damaged part or wires that are loose or frayed.

Battery gas can explode and cause serious injury. Use the procedure in the Operation & Maintenance Manual for connecting the battery and for jump starting. Do not jump start or charge a frozen or damaged battery. Keep any open flames or sparks away from batteries. Do not smoke in battery charging area.

Hydraulic System

Check hydraulic tubes, hoses and fittings for damage and leakage. Never use open flame or bare skin to check for leaks. Hydraulic tubes and hoses must be properly routed and have adequate support and secure clamps. Tighten or replace any parts that show leakage.

Always clean fluid spills. Do not use gasoline or diesel fuel for cleaning parts. Use commercial nonflammable solvents.

Fueling



Stop the engine and let it cool before adding fuel. No smoking! Do not refuel a machine near open flames or sparks. Fill the fuel tank outdoors.

Starting

Do not use ether or starting fluids on any engine that has glow plugs or air intake heater. These starting aids can cause explosion and injure you or bystanders.

Use the procedure in the Operation & Maintenance Manual for connecting the battery and for jump starting.

Spark Arrestor Exhaust System

The spark arrestor exhaust system is designed to control the emission of hot particles from the engine and exhaust system, but the muffler and the exhaust gases are still hot.

Check the spark arrestor exhaust system regularly to make sure it is maintained and working properly. Use the procedure in the Operation & Maintenance Manual for cleaning the spark arrestor muffler (if equipped).

SI SSL-1008 SM

FIRE PREVENTION (CONT'D)

Welding And Grinding

Always clean the machine and attachment, disconnect the battery, and disconnect the wiring from the Bobcat controllers before welding. Cover rubber hoses, battery and all other flammable parts. Keep a fire extinguisher near the machine when welding.

Have good ventilation when grinding or welding painted parts. Wear dust mask when grinding painted parts. Toxic dust or gas can be produced.

Dust generated from repairing nonmetallic parts such as hoods, fenders or covers can be flammable or explosive. Repair such components in a well ventilated area away from open flames or sparks.

Fire Extinguishers

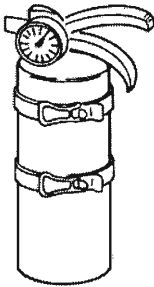

Know where fire extinguishers and first aid kits are located and how to use them. Inspect the fire extinguisher and service the fire extinguisher regularly. Obey the recommendations on the instructions plate.

SERIAL NUMBER LOCATIONS

Always use the serial number of the loader when requesting service information or when ordering parts. Early or later models (identification made by serial number) may use different parts, or it may be necessary to use a different procedure in doing a specific service operation.

Loader Serial Number

Figure 1

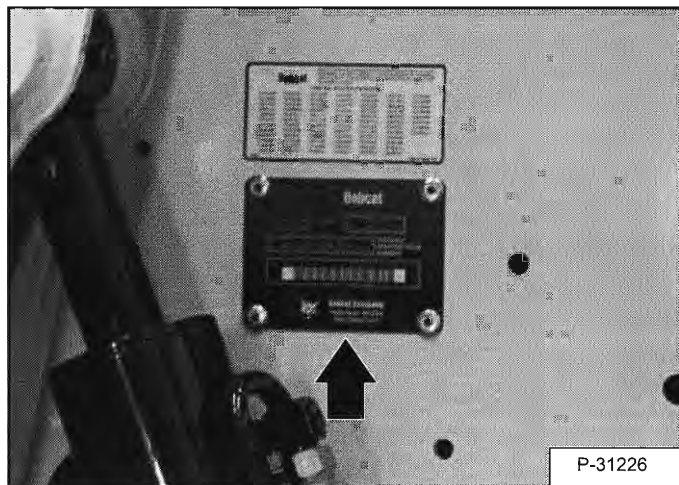

The loader serial number plate is located on the outside of the loader frame [Figure 1].

Explanation of loader Serial Number:

XXXX	XXXXX
Model 1.-Model/ Engine Combination	Model 2.-Production Sequence (Series)

1. The four digit Model/Engine Combination Module number identifies the model number and engine combination.
2. The five digit Production Sequence Number identifies the order which the loader is produced.

Engine Serial Number

Figure 2

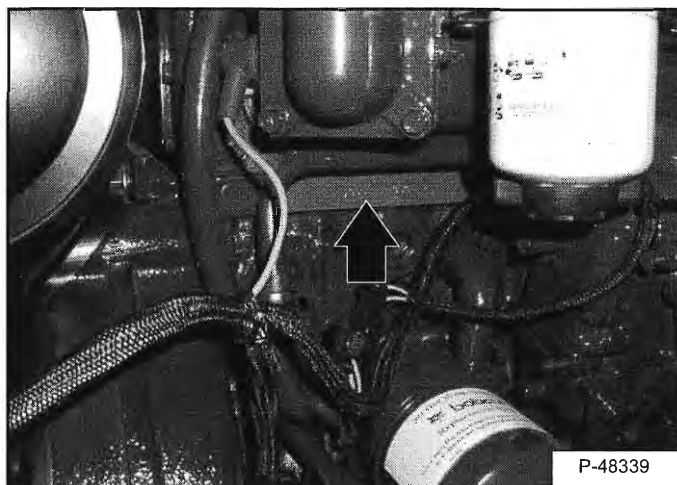

The engine serial number is located on the engine block [Figure 2].

DELIVERY REPORT

Figure 3

The diagram shows a rectangular form with a border. At the top right, it is titled "DELIVERY REPORT". Below this title, there is a smaller rectangular box containing the word "WARNING" in a bold, black header. The rest of the form is filled with horizontal lines, representing text input fields. In the bottom right corner of the form, there is a small box containing the alphanumeric code "B-16315".

The Delivery Report must be filled out by the dealer and signed by the owner or operator when the Bobcat loader is delivered. An explanation of the form must be given to the owner. Make sure it is filled out completely [Figure 3].

LOADER IDENTIFICATION

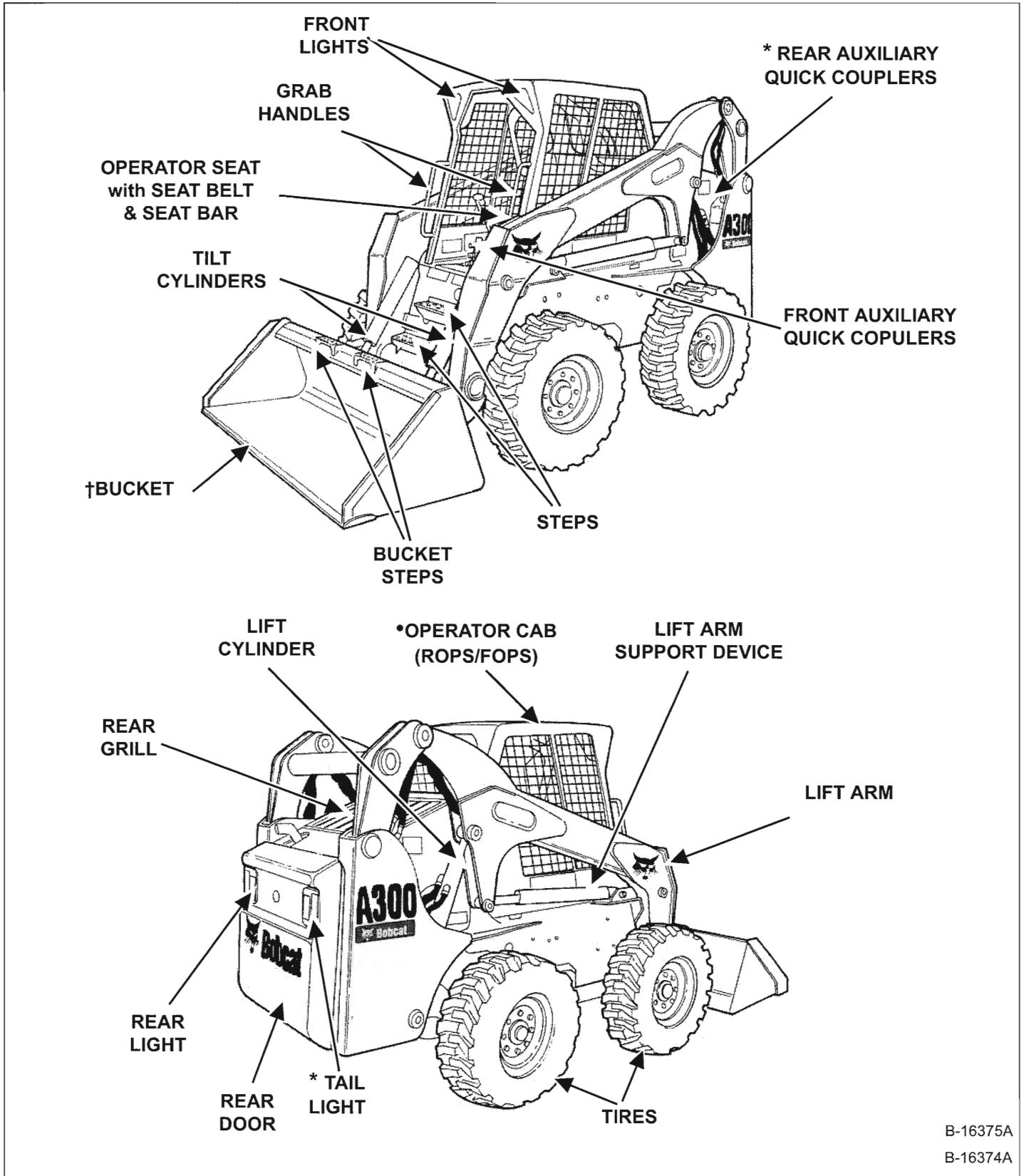

B-16375A

B-16374A

• ROPS, FOPS (Roll Over Protective Structure, per SAE J1040 and ISO 3471, and Falling Object Protective Structure per SAE J1043 and ISO 3449, Level I. Level II is available.

† Many different buckets and other attachments are available.

* Option or Accessory, not standard equipment.

Dear

**Thanks very much for your visiting and
patience.**

Want to get more information,

Please click here, Go back to the page.

**After your payment, you will have instant access to
your download.**

The Download Link will also be sent to your e-mail.

You will get the complete manual

Have any questions

please write to me

admin@servicemanualperfect.com