

4  
5  
0

4  
5  
3



# Service Manual

(450-S/N 561711001 & Above)  
(453-S/N 561811001 & Above)

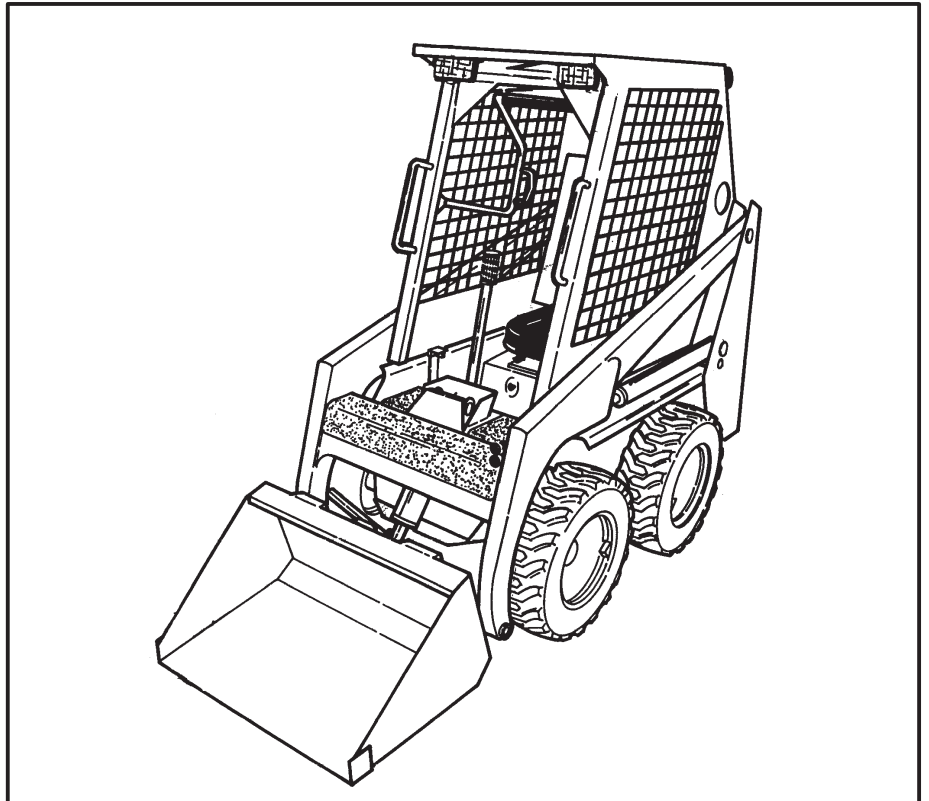

EQUIPPED WITH  
BOBCAT INTERLOCK  
CONTROL SYSTEM (BICS™)

**MELROE**  
**INGERSOLL-RAND**

6724259(1-96)

Printed in U.S.A.



© Melroe Company 1996



# MAINTENANCE SAFETY



## WARNING

Instructions are necessary before operating or servicing machine. Read and understand the Operation & Maintenance Manual, Operator's Handbook and signs (decals) on machine. Follow warnings and instructions in the manuals when making repairs, adjustments or servicing. Check for correct function after adjustments, repairs or service. Untrained operators and failure to follow instructions can cause injury or death.

W-2003-0903



**Safety Alert Symbol:** This symbol with a warning statement, means: "Warning, be alert! Your safety is involved!" Carefully read the message that follows.

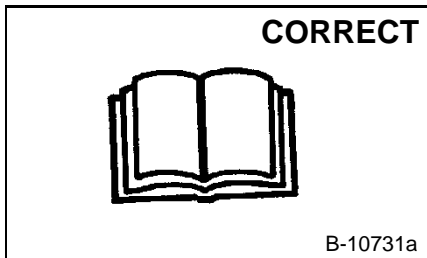

Never service the Bobcat Skid-Steer Loader without instructions.

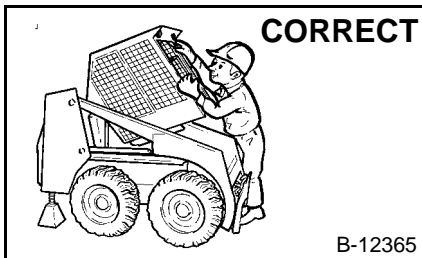

Use the correct procedure to lift or lower operator cab.

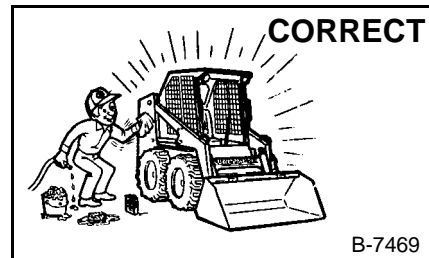

Cleaning and maintenance are required daily.

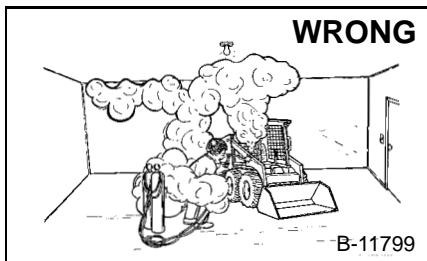

- Have good ventilation when welding or grinding painted parts.
- Wear dust mask when grinding painted parts. Toxic dust and gas can be produced.
- Avoid exhaust fume leaks which can kill without warning. Exhaust system must be tightly sealed.

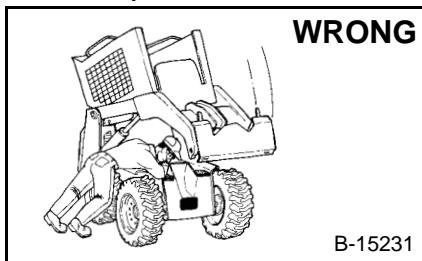

Disconnecting or loosening any hydraulic tubeline, hose, fitting, component or a part failure can cause lift arms to drop. Do not go under lift arms when raised unless supported by an approved lift arm support device. Replace it if damaged.

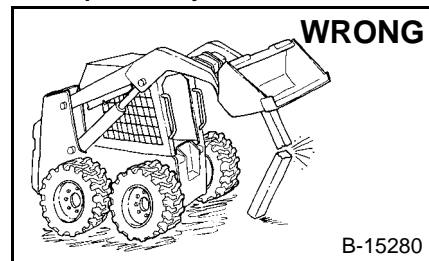

- Never work on loader with lift arms up unless lift arms are held by an approved lift arm support device. Replace if damaged.
- Never modify equipment or add attachments not approved by Bobcat Company.

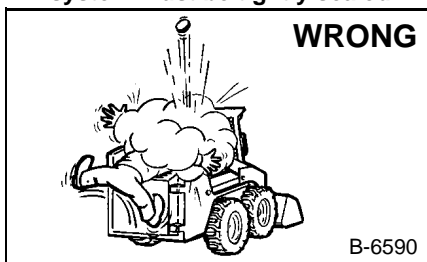

- Stop, cool and clean engine of flammable materials before checking fluids.
- Never service or adjust loader with the engine running unless instructed to do so in the manual.
- Avoid contact with leaking hydraulic fluid or diesel fuel under pressure. It can penetrate the skin or eyes.
- Never fill fuel tank with engine running, while smoking or when near open flame.

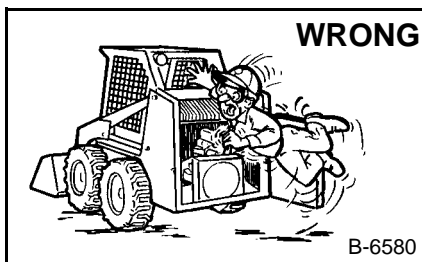

- Keep body, jewelry and clothing away from moving parts, electrical contact, hot parts and exhaust.
- Wear eye protection to guard from battery acid, compressed springs, fluids under pressure and flying debris when engines are running or tools are used. Use eye protection approved for type of welding.
- Keep rear door closed except for service. Close and latch door before operating the loader.

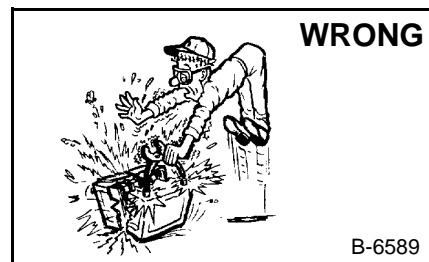

- Lead-acid batteries produce flammable and explosive gases.
- Keep arcs, sparks, flames and lighted tobacco away from batteries.
- Batteries contain acid which burns eyes or skin on contact. Wear protective clothing. If acid contacts body, flush well with water. For eye contact flush well and get immediate medical attention.

Maintenance procedures which are given in the Operation & Maintenance Manual can be performed by the owner/operator without any specific technical training. Maintenance procedures which are **not** in the Operation & Maintenance Manual must be performed **ONLY BY QUALIFIED BOBCAT SERVICE PERSONNEL**. Always use genuine Bobcat replacement parts. The Service Safety Training Course is available from your Bobcat dealer.



**Bobcat®**

## ALPHABETICAL INDEX

AIR CLEANER SERVICE .....	1-1	OIL COOLER AND SHROUDING .....	7B-1
ALTERNATOR .....	6-1	OPERATOR CAB .....	1-1, 5-1
ALTERNATOR BELT ADJUSTMENT (453) .....	1-1	OPERATOR CAB GAS CYLINDER .....	5-1
ASSEMBLY OF THE ENGINE .....	7B-1	OPERATOR SEAT .....	5-1
AUXILIARY CONTROL LOCKBOLT .....	1-1		
AXLE HUB .....	4-1	PARKING BRAKE PEDAL .....	4-1
AXLE SEAL .....	4-1	PARKING BRAKE DISC .....	4-1
AXLE, BEARINGS AND SPROCKET .....	4-1	PEDAL INTERLOCK LINKAGE .....	2-1
		PIVOT PINS .....	1-1
BATTERY .....	6-1	RADIATOR .....	7B-1
BICS™ SYSTEM CONTROLLER .....	8-1	REAR DOOR .....	5-1
BOBCAT INTERLOCK		REAR LIGHTS (OPTIONAL) .....	6-1
CONTROL SYSTEM (BICS™) .....	8-1	REAR WINDOW .....	5-1
BOB-TACH .....	1-1, 5-1	REMOTE START SWITCH .....	1-1
		REPAIRING THE ENGINE .....	7B-1
CARBURETOR AND GOVERNOR .....	7A-3		
CHAINCASE COVERS .....	4-1	SEAT BAR .....	5-1
CHAINCASE FLUID .....	4-1	SEAT BAR RESTRAINT SYSTEM .....	1-1
CONTROL PEDALS .....	2-1	SEAT BAR SENSOR .....	8-1
CONTROL SHIELD AND		SEAT SENSOR .....	8-1
STEERING LEVER PANELS .....	3-1	SERVICE SCHEDULE .....	1-1
CYLINDER HEAD .....	7B-1	SPARK ARRESTOR MUFFLER .....	1-1
		STANDARD TORQUE SPECIFICATIONS	
DECIMAL & MILLIMETER EQUIVALENTS .....	9-1	FOR BOLTS .....	9-1
DRIVE BELT .....	3-1	STARTER .....	6-1
DRIVE CHAIN .....	4-1	STEERING LEVERS .....	3-1
		STEERING LINKAGE .....	3-1
ELECTRICAL SYSTEM .....	1-1		
ELECTRICAL SYSTEM INFORMATION .....	6-1	TENSION PULLEY AND SPRING .....	3-1
ENGINE .....	7A-3, 7B-1	TILT CYLINDER .....	2-1
ENGINE ASSEMBLY .....	7A-3	TIRE MAINTENANCE .....	1-1
ENGINE COOLING SYSTEM .....	1-1	TOWING THE LOADER .....	1-1
ENGINE DISASSEMBLY .....	7A-3	TRACTION LOCK .....	8-1
ENGINE LUBRICATION SYSTEM .....	1-1	TRANSPORTING THE LOADER .....	1-1
ENGINE SPECIFICATIONS .....	9-1	TROUBLESHOOTING .....	2-1, 3-1, 6-1, 7A-3, 7B-1
ENGINE SPEED CONTROL .....	7B-1		
FAN .....	7B-1	U.S. TO METRIC CONVERSION .....	9-1
FINAL DRIVE TRANSMISSION (CHAINCASE) .....	1-1		
FLYWHEEL .....	7A-3		
FRONT LIGHTS (OPTIONAL) .....	6-1		
FUEL SYSTEM .....	1-1, 7B-1		
FUEL TANK .....	5-1		
GLOSSARY OF HYDRAULIC SYMBOLS .....	9-1		
HYDRAULIC CONTROL VALVE .....	2-1		
HYDRAULIC CYLINDERS .....	2-1		
HYDRAULIC FILTER BLOCK .....	3-1		
HYDRAULIC/HYDROSTATIC			
FLUID SPECIFICATIONS .....	9-1		
HYDRAULIC/HYDROSTATIC SYSTEM .....	1-1		
HYDRAULIC PUMP .....	2-1		
HYDRAULIC RESERVOIR .....	2-1		
HYDRAULIC SYSTEM INFORMATION .....	2-1		
HYDROSTATIC MOTOR .....	3-1		
HYDROSTATIC PUMP .....	3-1		
HYDROSTATIC SYSTEM INFORMATION .....	3-1		
IGNITION SYSTEM .....	7A-3		
INSTRUMENT PANEL .....	6-1		
LIFT ARM BY-PASS BLOCK .....	2-1		
LIFT ARM SUPPORT DEVICE .....	1-1		
LIFT ARMS .....	5-1		
LIFT CYLINDER(S) .....	2-1		
LIFT AND TILT LOCK BY-PASS VALVE .....	8-1		
LIFTING AND BLOCKING THE LOADER .....	1-1		
LIFTING THE LOADER .....	1-1		
LOADER SPECIFICATIONS .....	9-1		
LUBRICATING THE LOADER .....	1-1		



# CONTENTS

FOREWORD .....	ii
SAFETY INSTRUCTIONS .....	v
SERIAL NUMBER LOCATIONS .....	vii
DELIVERY REPORT .....	vii
BOBCAT LOADER IDENTIFICATION .....	viii
PREVENTIVE MAINTENANCE .....	1-1
HYDRAULIC SYSTEM .....	2-1
HYDROSTATIC SYSTEM .....	3-1
DRIVE SYSTEM .....	4-1
MAIN FRAME .....	5-1
ELECTRICAL SYSTEM .....	6-1
ENGINE SERVICE .....	7-1
BICS™ SYSTEM .....	8-1
SPECIFICATIONS .....	9-1

**CALIFORNIA  
PROPOSITION 65 WARNING**  
Diesel engine exhaust and some of its  
constituents are known to the State of California  
to cause cancer, birth defects and other  
reproductive harm.

**PREVENTIVE  
MAINTENANCE**

**HYDRAULIC  
SYSTEM**

**HYDROSTATIC  
SYSTEM**

**DRIVE  
SYSTEM**

**MAIN  
FRAME**

**ELECTRICAL  
SYSTEM**

**ENGINE  
SERVICE**





**BICS™  
SYSTEM**

**SPECIFICATIONS**

# FOREWORD

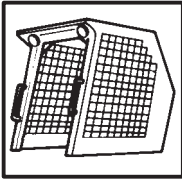
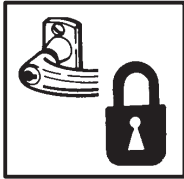
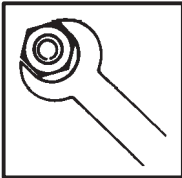
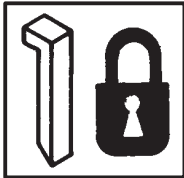
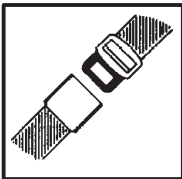
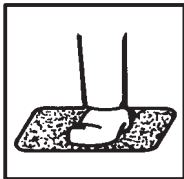
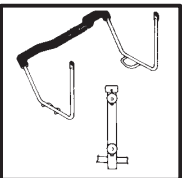
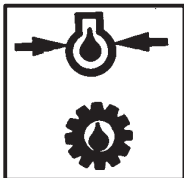
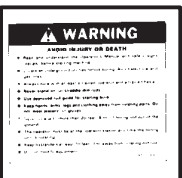
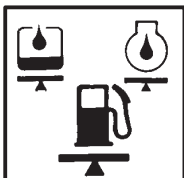
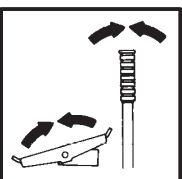
This manual is for the Bobcat loader mechanic. It provides necessary servicing and adjustment procedures for the Bobcat loader and its component parts and systems. Refer to the Operation & Maintenance Manual for operating instructions, starting procedure, daily checks, etc.

A general inspection of the following items must be made after the loader has had service or repair:

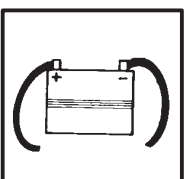
- |  |   |   |   |
|--|---|---|---|
| <p>1. Check that the ROPS/FOPS (Including sidescreens) is in good condition and is not modified.</p> |    | <p>9. Enclosure door latches must open and close freely.</p>                              |    |
| <p>2. Check that ROPS mounting hardware is tightened and is Melroe approved.</p>                     |    | <p>10. Bob-Tach wedges and linkages must function correctly and be in good condition.</p> |    |
| <p>3. The seat belt must be correctly installed, functional and in good condition.</p>               |    | <p>11. Safety treads must be in good condition.</p>                                       |    |
| <p>4. The seat bar and pedal interlocks must be correctly adjusted, clean and lubricated.</p>        |   | <p>12. Check for correct function of indicator lamps (Optional on some models).</p>       |   |
| <p>5. Machine signs must be legible and in the correct location.</p>                                 |  | <p>13. Check hydraulic fluid level, engine oil level and fuel supply.</p>                 |  |
| <p>6. Steering levers and foot pedals must return to neutral.</p>                                    |  | <p>14. Inspect for fuel, oil or hydraulic fluid leaks.</p>                                |  |
| <p>7. Check for correct function of the work lights.</p>   |  | <p>15. Lubricate the loader.</p>  |  |
| <p>8. The parking brake must function correctly.</p>   |  | <p>16. Check the condition of the battery and cables.</p>                                 |  |



17. Inspect the air cleaner for damage or leaks. Check the condition of the element.

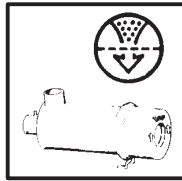

18. Check the electrical charging system.

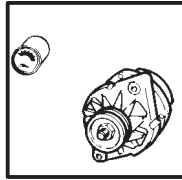

19. Check tires for wear and pressure.

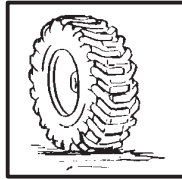

20. Inspect for loose or broken parts or connections.

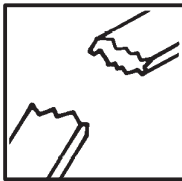

21. Operate the loader and check all functions.

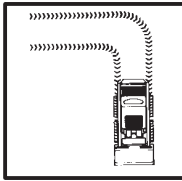

22. Check for any field modification not completed.



23. Check for correct function of the Bobcat Interlock Control System (BICS™) before the machine is returned to the customer.

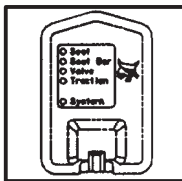

Recommend to the owner that all necessary corrections be made before the machine is returned to service.

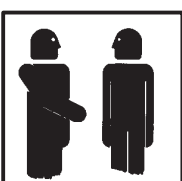

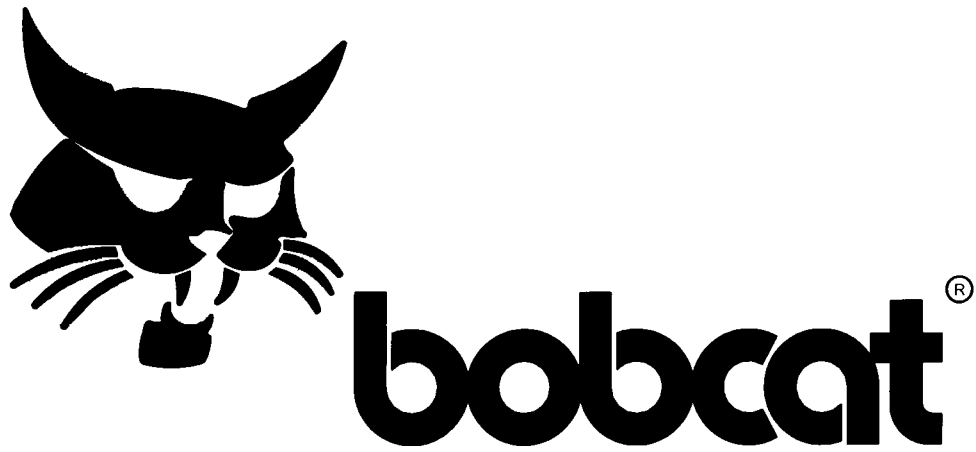

## SAFETY INSTRUCTIONS

# **WARNING**

Instructions are necessary before operating or servicing machine. Read Operation & Maintenance Manual, Handbook and signs (decals) on machine. Follow warnings and instructions in the manuals when making repairs, adjustments or servicing. Check for correct function after adjustments, repairs or service. Failure to follow instructions can cause injury or death.

W-2003-0797

The following publications provide information on the safe use and maintenance of the loader and attachments:

- The Delivery Report is used to assure that complete instructions have been given to the new owner and that the machine is in safe operating condition.
- The Operation & Maintenance Manual delivered with the loader gives operating information as well as routine maintenance and service procedures. It is a part of the loader and must stay with the machine when it is sold. Replacement Operation & Maintenance Manuals can be ordered from your Bobcat loader dealer.
- The loader has machine signs (decals) which instruct on the safe operation and care. The signs and their locations are shown in the Operation & Maintenance Manual. Replacement signs are available from your Bobcat loader dealer.
- The loader has a plastic Operator's Handbook fastened to the operator cab. Its brief instructions are convenient to the operator. The Handbook is available from your dealer in an English edition or one of many other languages. See your Bobcat dealer for more information on translated versions.
- The EMI Safety Manual (available in Spanish) delivered with the loader gives general safety information.
- The Service Manual and Parts Manual are available from your dealer for use by mechanics to do shop-type service and repair work.
- The Skid-Steer Loader Operator Training Course is available through your local dealer. This course is intended to provide rules and practices for correct operation of the Bobcat loader. The course is available in English and Spanish version.
- The Bobcat Skid-Steer Loader Safety Video is available from your Bobcat Dealer.

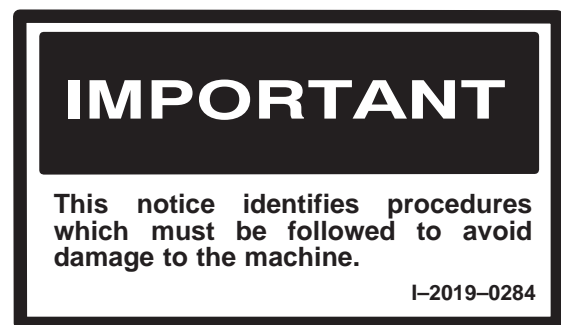

**Safety Alert Symbol:** This symbol with a warning statement, means: "Warning, be alert! Your safety is involved!" Carefully read the message that follows.

## SAFETY INSTRUCTIONS (Cont'd)

- Wear tight fitting clothing. Always wear safety glasses when maintaining or servicing loader. Safety glasses, hearing protection or loader special applications kit are required for some work. See your dealer for Melroe Safety equipment.
- Know where fire extinguisher and first aid kit are located and how to use them.
- Do not use the Bobcat loader where exhaust, arcs, sparks or hot components can contact flammable material, explosive dust or gases.
- The engine compartment and engine cooling system must be inspected every day and cleaned if necessary to prevent fire hazard and overheating.
- Check all electrical wiring and connections for damage. Keep the battery terminals clean and tight. Repair or replace any damaged part.
- Check fuel and hydraulic tubes, hoses and fittings for damage and leakage. Never use open flame or bare skin to check for leaks. Tighten or replace any parts that show leakage. Always clean fluid spills. Do not use gasoline or diesel fuel for cleaning parts. Use commercial nonflammable solvents.
- Follow any environmental safety regulations when disposing of used fluids such as engine oil, grease or anti-freeze.
- Do not use ether or starting fluids on engines which have glow plugs. These starting aids can cause explosion and injure you or bystanders.
- Always clean the loader and disconnect the battery before doing any welding. Cover rubber hoses, battery and all other flammable parts. Keep a fire extinguisher near the loader when welding. Have good ventilation when grinding or welding painted parts. Wear dust mask when grinding painted parts. Toxic dust or gas can be produced.
- Stop the engine and let it cool before adding fuel. No smoking!
- Use the procedure in the Operation & Maintenance or Service Manuals for connecting the battery.

A fire extinguisher is available from your local dealer. The fire extinguisher can be installed in the location shown [A].



## SERIAL NUMBER LOCATIONS

Always use the serial number of the loader when requesting service information or when ordering parts. Early or later models (identification made by serial number) may use different parts, or it may be necessary to use a different procedure in doing a specific service operation.

### LOADER SERIAL NUMBER

The loader serial number plate is located on the inside of the operator cab on the right fender and in front of the seat [A].

Explanation of loader Serial Number:

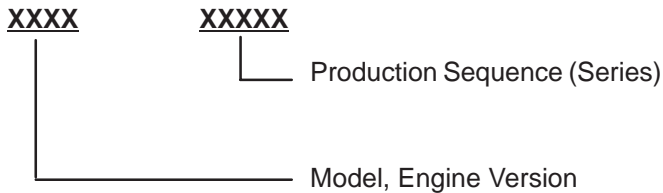

### ENGINE SERIAL NUMBER

The engine serial number is located on the engine fuel injection pump. [B].

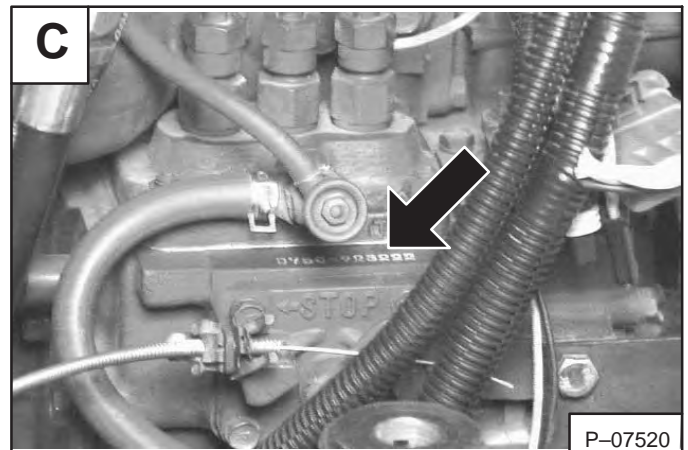
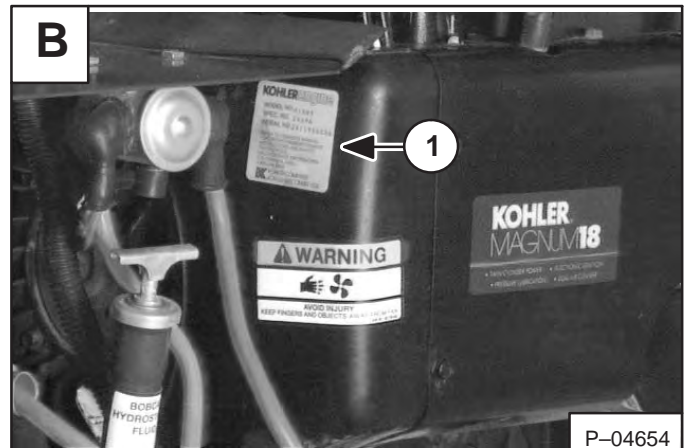

### DELIVERY REPORT

The Delivery Report must be filled out by the dealer and signed by the owner or operator when the Bobcat loader is delivered. An explanation of the form must be given to the owner. Make sure it is filled out completely [C].

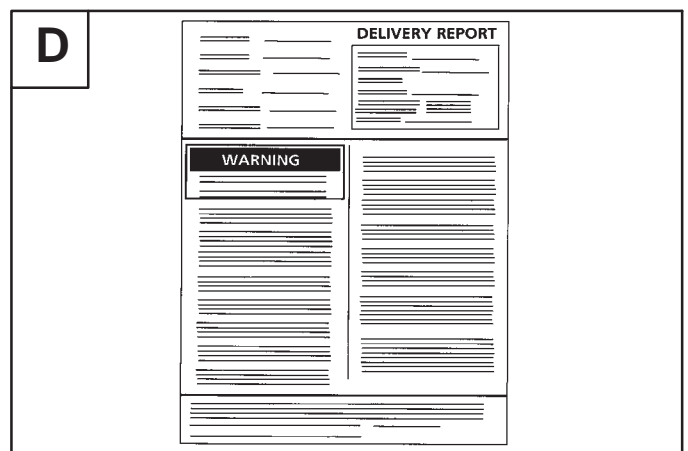

# BOBCAT SKID STEER LOADER IDENTIFICATION

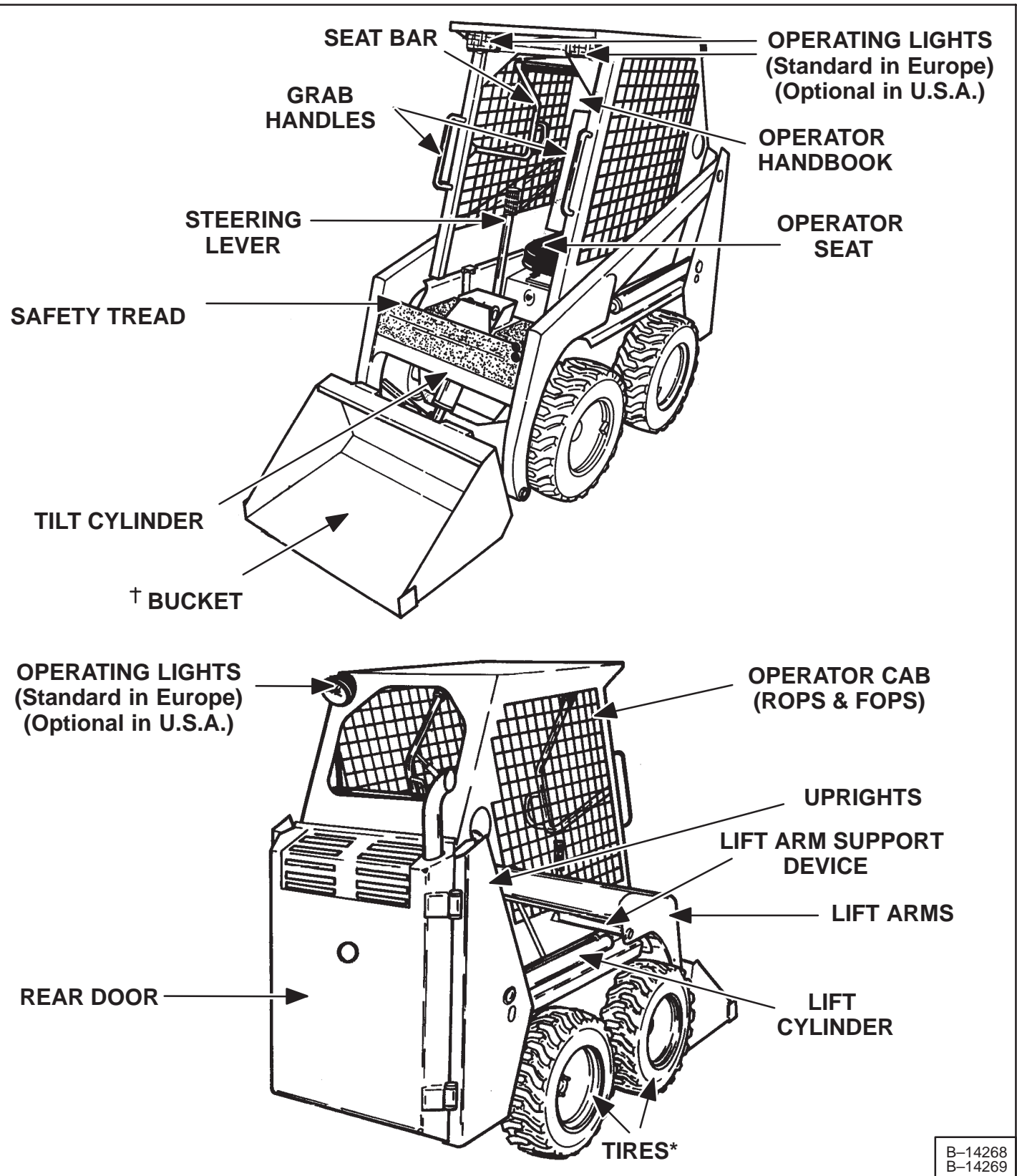

B-14268  
B-14269

- \* TIRES – Flotation tires (Optional) are shown. Bobcats are base-equipped with standard tires.
- † BUCKET – Several different buckets and other attachments are available for the Bobcat loader.
- ROPS, FOPS – Roll-Over Protective Structure, Falling Object Protective Structure, per SAE J1040 and ISO 3471, and Falling Object Protective Structure per SAE J1043 and ISO 3449, Level I. The Bobcat loader is base-equipped with a standard operator cab as shown. Extra insulated cab is available as an option (Reduced noise level).

# OPTIONS AND ACCESSORIES

All 453 Bobcat loaders are equipped with the following standard items:

Spark Arrestor Muffler	Seat Belt
Lift Arm Support Device	Seat Bar
Operator Cab (W/ROPS & FOPS Approval)	Parking Brake
Bobcat Interlock Control System (BICS™)	Hourmeter
Gauges/Warning Lights (453)	

Below is a listing of the optional equipment which is available through your Bobcat Loader dealer.

## **Tires**

5:70 x 12, 4PR .....	Std.
23 x 8:50-12, 4PR .....	Opt.
23 x 8:50-12,6 PR Heavy Duty .....	Opt.

## **Operator Cab**

85 dB(A) Sound Package .....	Opt. (Std. in Europe)
Suspension Seat .....	Opt. & FA (Std. in Europe)
Operating Lights (Front & Rear) .....	Opt. & FA (Std. in Europe)
Horn .....	FA (Std. in Europe)
Back-Up Alarm .....	Opt. & FA
Top Window .....	Opt. & FA (Std. in Europe)
Rear Window .....	Opt. & FA (Std. in Europe)
Vinyl Cab Enclosure .....	FA
Fire Extinguisher .....	FA
Flasher Lights .....	FA
Strobe or Rotating Beacon Light .....	FA
3" Seat Belt .....	FA
Special Application Kit .....	FA
Turn Signal Kit .....	FA in Europe
Fuel Shutoff Kit .....	FA
Operator Training Kit .....	FA
Padlock (Tailgate) .....	Std. in Europe

## **Hydraulics**

Front Auxiliary Hydraulics .....	Opt. & FA
----------------------------------	-----------

## **Other**

Engine Block Heater (453) .....	FA
Single Point Lift .....	FA
Locking Fuel Cap .....	FA
Tool Box .....	FA (Std. In Europe)
Low Coolant Sensor Kit .....	FA
Rental Kit .....	FA

Std. = Standard Equipment  
 Opt. = Factory Installed Option  
 FA = Field Accessory  
 NA = Not Available

***Specifications subject to  
 change without notice***





# PREVENTIVE MAINTENANCE

## PREVENTIVE MAINTENANCE

	Page Number
AIR CLEANER SERVICE	
450 Loader .....	1-12
453 Loader .....	1-13
ALTERNATOR BELT ADJUSTMENT (453) .....	1-21
AUXILIARY CONTROL LOCKBOLT .....	1-25
BOB-TACH .....	1-27
ELETRICAL SYSTEM	
Description .....	1-21
ENGINE COOLING SYSTEM	
450 Loader .....	1-19
453 Loader .....	1-20
Cleaning The Cooling System .....	1-19 & 1-20
Checking The Coolant Level .....	1-20
Propylene Glycol .....	1-20
Removing Coolant From The Cooling System .....	1-20
ENGINE LUBRICATION SYSTEM	
450 Loader .....	1-17
453 Loader .....	1-18
Replacing Oil And Filter .....	1-17 & 1-18
FINAL DRIVE TRANSMISSION (CHAINCASE)	
Checking and Adding Oil .....	1-25
FUEL SYSTEM	
450 Loader .....	1-14
453 Loader .....	1-14
Filling The Fuel Tank .....	1-14 & 1-15
Fuel Filter .....	1-14 & 1-15
Fuel Specifications .....	1-15
Removing Air From The Fuel System .....	1-16
HYDRAULIC/HYDROSTATIC SYSTEM	
Checking And Adding Fluid .....	1-23
Replacing Hydraulic/Hydrostatic Filter Element .....	1-24
Removing Hydraulic/Hydrostatic Fluid .....	1-24
LIFT ARM SUPPORT DEVICE	
Engaging The Lift Arm Support Device .....	1-7
Disengaging The Lift Arm Support Device .....	1-7
LIFTING AND BLOCKING THE LOADER	
Procedure .....	1-4
LIFTING THE LOADER	
Single Point Lift .....	1-6
LUBRICATION OF THE LOADER .....	1-26

## PREVENTIVE MAINTENANCE (Cont'd)

	<b>Page Number</b>
OPERATOR CAB	
Description .....	1-9
Emergency Exit .....	1-9
Lowering The Operator Cab .....	1-10
Raising The Operator Cab .....	1-9
PIVOT PINS .....	1-22
REMOTE START SWITCH	
450 .....	1-29
453 .....	1-28
Procedure .....	1-29
SEAT BAR RESTRAINT SYSTEM	
Foot Pedal Clean Out .....	1-11
Seat Bar Inspection .....	1-11
Seat Bar Maintenance .....	1-11
SERVICE SCHEDULE	
Chart .....	1-3
SPARK ARRESTOR MUFFLER	
Cleaning The Spark Arrestor Muffler .....	1-22
TIRE MAINTENANCE	
Tire Inflation .....	1-25
Tire Rotation .....	1-25
Wheel Nuts .....	1-25
TOWING THE LOADER .....	1-6
TRANSPORTING THE LOADER	
Procedure .....	1-5

## SERVICE SCHEDULE

Maintenance work must be done at regular intervals. Failure to do so will result in excessive wear and early failures. The service schedule is a guide for correct maintenance of the Bobcat loader.



# WARNING

Instructions are necessary before operating or servicing machine. Read Operation & Maintenance Manual, Handbook and signs (decals) on machine. Follow warnings and instructions in the manuals when making repairs, adjustments or servicing. Check for correct function after adjustments, repairs or service. Failure to follow instructions can cause injury or death.

W-2003-0797

SERVICE SCHEDULE		HOURS					
ITEM	SERVICE REQUIRED	8-10	50	100	250	500	1000
Engine Air Cleaner	Empty the dust cup & replace the filter element as needed.						
Engine Oil	Check the oil level & add oil as needed.						
Engine Cooling System (453)	Clean debris from oil cooler, radiator & grill. Check coolant level in recovery tank and add as needed.						
Tires	Check the air pressure & for damaged tires.						
Indicators, Gauges (453) & Lights (Opt.)	Check for correct operation of all indicators, gauges (453) & lights (Opt.).						
Seat Belt and Seat Bar	Check the condition of seat belt. Check the seat bar & pedal interlocks for correct operation. Clean dirt and debris from moving parts.						
Safety Signs (Decals) and Safety Tread	Check for damaged signs and safety treads. Replace any signs or safety treads that are damaged or worn.						
Lift Arm and Bob-Tach Pivot Pin and Wedges	Lubricate with multi-purpose lithium based grease.						
Engine Fuel Filter (453)	Remove the water from the filter.						
Hyd. Fluid, Hoses & Tubelines	Check fluid level & add as needed. Check for damage & leaks. Repair & replace as needed.						
Bobcat Interlock Control System (BICS™)	Check BICS™ System Controller functions. Clean dirt, debris or objects from under or behind seat as required.						
Engine Oil & Filter (450)	Replace oil & filter.						
Battery	Check cables connections & electrolyte level. Add distilled water as needed.						
Control Pedals & Steering	Check for correct operation repair or adjust as needed.						
Bob-Tach	<input type="checkbox"/> Check locking levers & wedges for condition & operation.						
Wheel Nuts	Check for loose wheel nuts & tighten to 40-45 ft.-lbs. (54-61 Nm) torque						
Parking Brake	Check operation.						
Alternator Belt (453 Only)	Check tension & adjust as needed.						
Hydraulic Filter Element	Replace filter element.						
Spark Arrestor Muffler	Clean the spark chamber.						
Engine Oil & Filter (453)	Replace oil & filter.						
Drive Belts	Check all drive belts for condition and tension.						
Steering Lever Pivots	Lubricate the grease fittings and the oil hole in the steering shaft.						
Engine Fuel Filter (453)	Replace filter element.						
Hydraulic Reservoir Fill Cap (Breather)	Replace the breather cap.						
Final Drive Transmission (Chaincase)	Replace the fluid.						
Hydraulic/Hydrostatic Reservoir	● Replace the fluid.						
Bobcat Interlock Control System (BICS™)	Check the lift arm bypass control.						
Case Drain Filter	Replace the Filter.						

- Check wheel nut torque every 8 hours for the first 24 hours.
- Also replace hydraulic/hydrostatic filter element when the transmission warning light stays on for five minutes after the fluid is at operating temperature.
- Or every 12 months.



# WARNING

Instructions are necessary before operating or servicing machine. Read Operation & Maintenance Manuals, Handbook and signs (decals) on machine. Follow warnings and instructions in the manuals when making repairs, adjustments or servicing. Check for correct function after adjustments, repairs or service. Failure to follow instructions can cause injury or death [A].

W-2003-0797

A



B-7023

## LIFTING AND BLOCKING THE LOADER

### Procedure

Always park the loader on a level surface.



# WARNING

Put jackstands under the front axles and rear corners of the frame before running the engine for service. Failure to use jackstands can allow the machine to fall or move and cause injury or death.

W-2017-0286

B



P-7288

Put a floor jack under the rear of the loader [B].

Lift the rear of the loader and install jackstands [B].

Put the floor jack under the front of the loader [C].

Lift the front of the loader and put jackstands under the loader frame.

**NOTE:** Make sure the jackstands do not touch the tires.

C

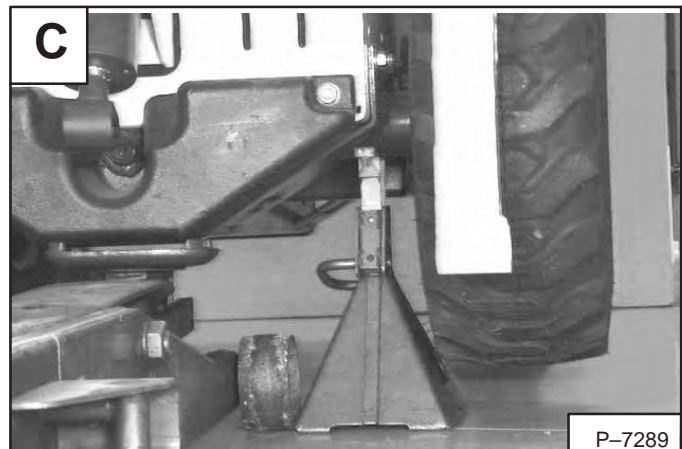

P-7289

## TRANSPORTING THE LOADER

### Procedure

Be sure the transport and towing vehicles are of adequate size and capacity.

# WARNING

Adequately designed ramps of sufficient strength are needed to support the weight of the machine when loading onto a transport vehicle. Wood ramps can break and cause personal injury.

W-2058-0494

A loader with an empty bucket or no attachment must be loaded backward onto the transport vehicle [A].

The rear of the trailer must be blocked or supported [A] when loading or unloading the loader to prevent the front end of the trailer from raising up.

Use the following procedure to fasten the Bobcat loader to the transport vehicle to prevent the loader from moving during sudden stops or when going up or down slopes [B].

Lower the bucket or attachment to the floor. Stop the engine. Engage the parking brake. Install chains at the front and rear of the loader as shown [B].

**NOTE:** Rear of the loader can be chained using the upright slots or using the loop below the rear door [C].

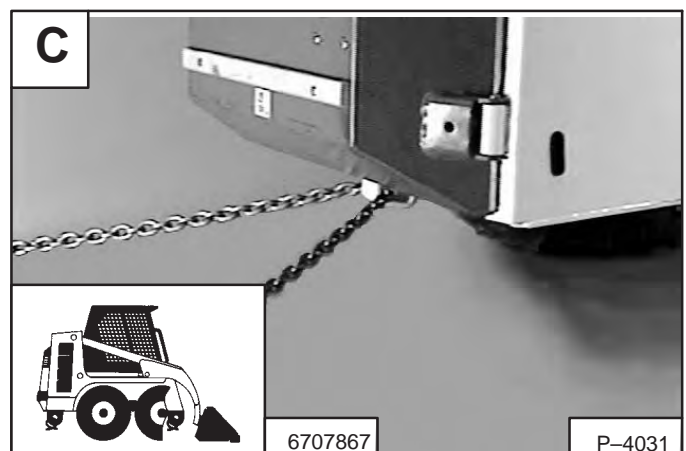
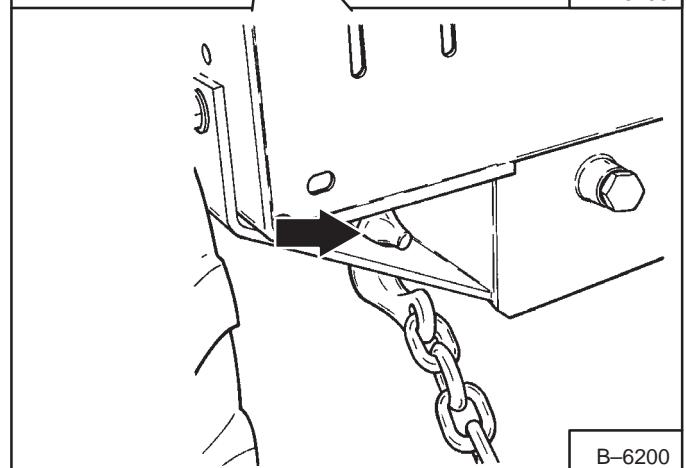
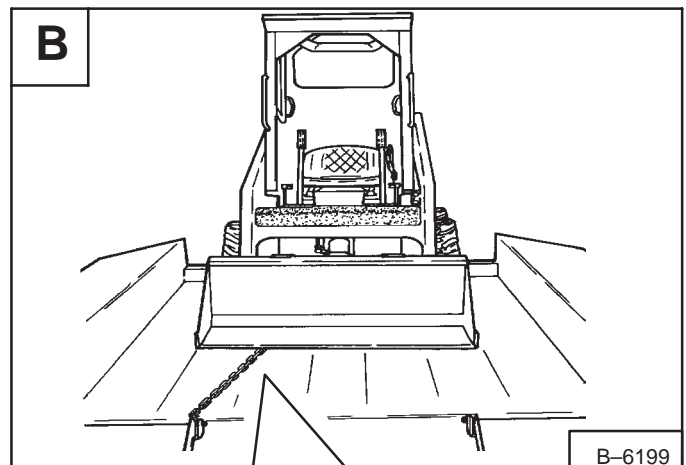
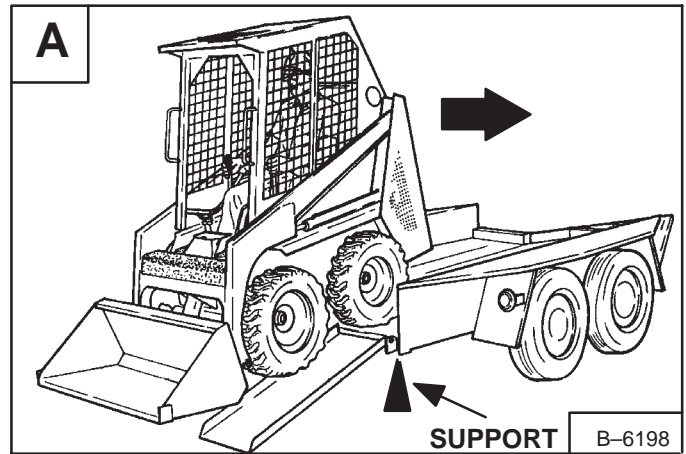

## LIFTING THE LOADER

### Single Point Lift



# WARNING

### AVOID INJURY OR DEATH

- Before lifting, check fasteners on single point lift and operator cab.
- Assemble front cab fasteners as shown in this manual.
- Never allow riders in the cab or bystanders within 15 feet (5 meters) while lifting the machine.

W-2007-0497

The loader can be lifted with the single point lift which is available as a kit from your Bobcat loader dealer.

Install the kit and lift the loader as shown [A].

The single point lift, supplied by Melroe Company is designed to safely lift and support the Bobcat loader without affecting roll over and falling object protection features of the operator cab.

## TOWING THE LOADER

To prevent damage to the loader's hydrostatic system, the loader must be towed only a short distance at slow speed. (Example: Moving the loader onto a transport vehicle).

Relief valve release tool set MEL1220 must be installed before towing.

Raise the operator cab. (See Page 1-9.)

Clean the area around the hydrostatic pumps.

Remove the high pressure relief valve from one side of each hydrostatic pump [B] and install the relief valve tubes. Install the plugs and tighten.

The towing chain (or cable) must be rated at 1-1/2 times the weight of the loader. (See *SPECIFICATIONS* Page 69.)

Turn the key switch to ON and press the traction lock override button.

Tow the Bobcat at 2 MPH (3,2 km/hr) or less for not more than 25 feet (7,6 meters).

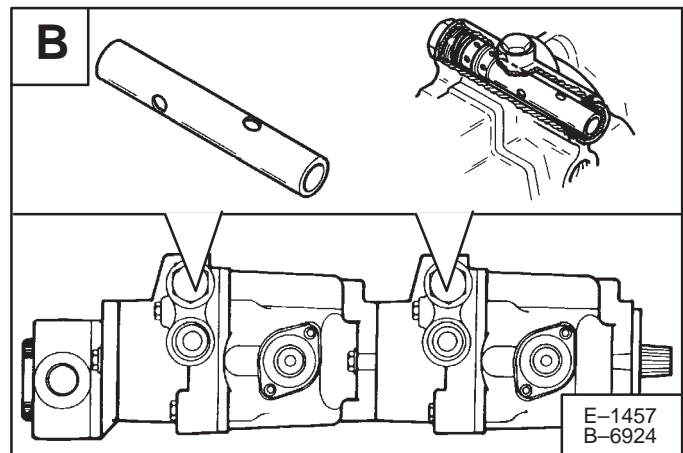
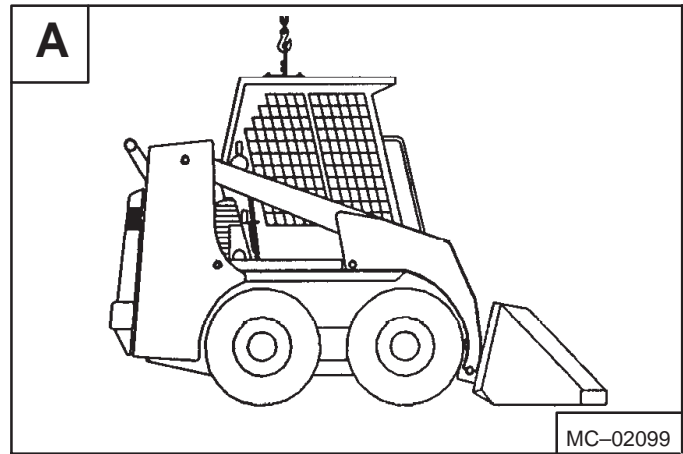

# IMPORTANT

**Never attempt to start the engine by pushing or pulling. Hydrostatic pumps and motors will be damaged.**

I-2001-1285

**Do not push or pull the machine at more than 2 MPH (3,2 km/h) or for a distance of more than 25 feet (7,6 meters) with the towing tool in place.**

I-2017-0389

## LIFT ARM SUPPORT DEVICE



# WARNING

Never work on a machine with the lift arms up unless the lift arms are secured by an approved lift arm support device. Failure to use an approved lift arm support device can allow the lift arms or attachment to fall and cause injury or death.

W-2059-0598

### Engaging The Lift Arm Support Device

Use the following procedure to use the lift arm support device:

Put jackstands under the rear corners of the loader. (See Page 1-4).

Disconnect the spring from the lift arm support device retaining pin (Item 1) [A], hold the support device and remove the retaining pin.

Lower the lift arm support device on top of the lift cylinder. Fasten the free end of the spring (Item 1) [B] to the lift arm support device so there will be no interference with the support device engagement.

With the operator in the seat, seat belt fastened and seat bar lowered, engage the parking brake and start the engine.

Raise the lift arms until the lift arm support device drops onto the lift cylinder rod [C].

Lower the lift arms slowly until the support device is held between the lift arm and the lift cylinder. Stop the engine. Raise the seat bar and move pedals until both pedals lock.

Install the retaining pin (Item 1) [D] into the rear of the lift arm support device below the cylinder rod.



# WARNING

Service lift arm support device if damaged or if parts are missing. Using a damaged lift arm support or with missing parts can cause lift arms to drop causing injury or death.

W-2271-1197

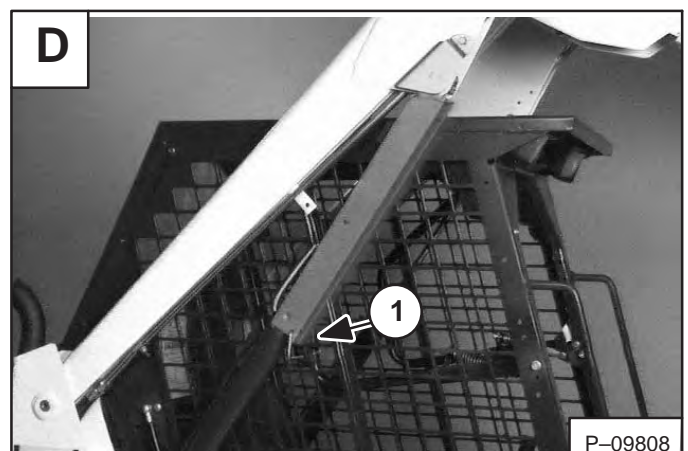
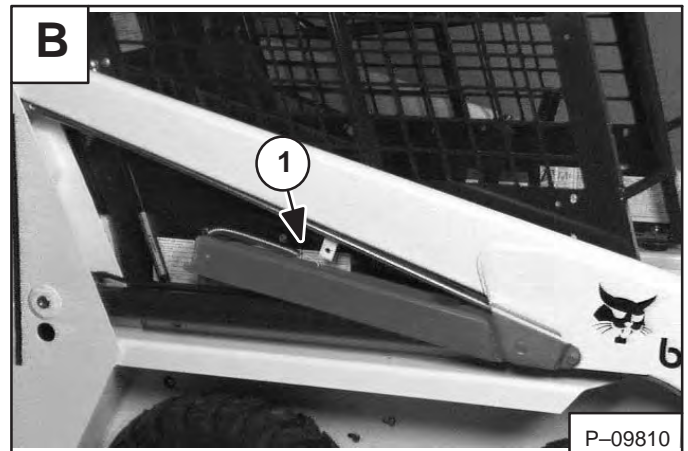
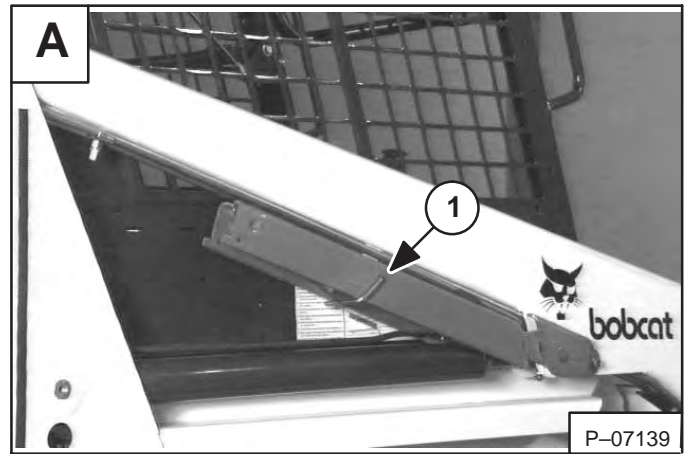

## LIFT ARM SUPPORT DEVICE (Cont'd)

### Disengaging The Lift Arm Support Device

Remove the retaining pin (Item 1) [A] from the lift arm support device.

Connect the spring from the lift arm support device to the tubeline bracket (Item 2) [A] on the lift arms.

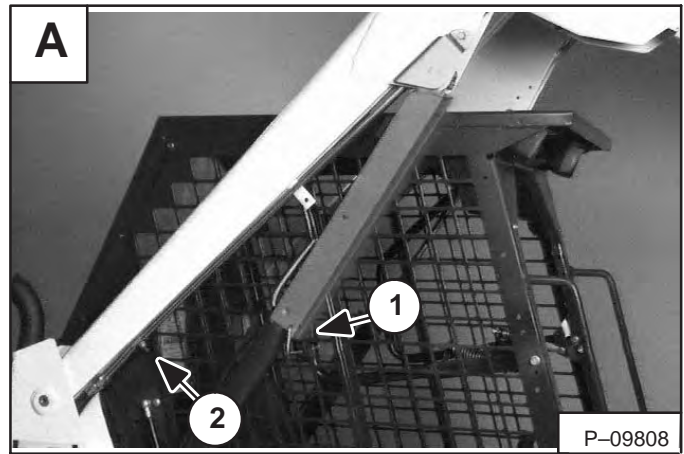

With the operator in the seat, seat belt fastened and seat bar lowered, start the engine [B].

Raise the lift arms a small amount and the spring will lift the support device off the lift cylinder rod. Lower the lift arms. Stop the engine.

Raise the seat bar and move pedals until both pedals lock.

Disconnect the spring from the bracket.



Raise the support device into storage position and insert pin through the lift arm support device and bracket (Item 1) [C].

Connect the spring to the pin [C].

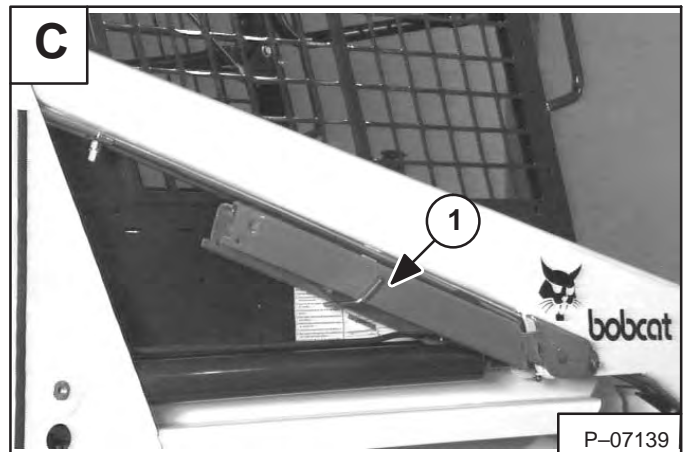



## OPERATOR CAB

### Description

The Bobcat loader has an operator cab (ROPS and FOPS) as standard equipment to protect the operator from rollover and falling objects. Check with your dealer if the operator cab has been damaged.

**ROPS/FOPS** Roll Over Protective Structure per SAE J1040 and ISO 3471, and Falling Object Protective Structure per SAE J1043 and ISO 3449, Level I.

**Level I** – Protection from falling bricks, small concrete blocks and hand tools encountered in operations such as highway maintenance, landscaping, and other construction site services.

### Emergency Exit

The front opening of the operator cab and rear window provide exits.

To exit through the rear window, use the following procedure:

Pull on the tag (Item 1) [A] at the top of the rear window to remove the rubber cord.

Push the window out of the rear of the operator cab.

Exit through the rear of the operator cab [B].

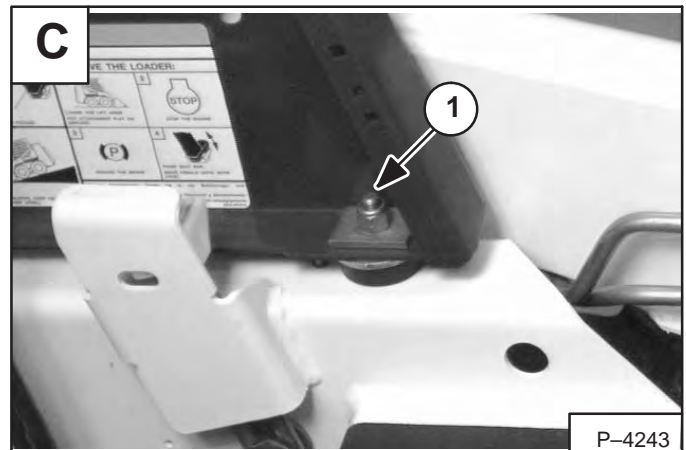

## WARNING

Never modify operator cab by welding, grinding, drilling holes or adding attachments unless instructed to do so by Melroe Company. Changes to the cab can cause loss of operator protection from rollover and falling objects, and result in injury or death.

W-2069-1285

Before the cab or the lift arms are raised for service, jackstands must be put under the rear corners of the frame. Failure to use jackstands can allow the machine to tip backward causing injury or death.

W-2014-0895

The operator cab fastening nuts (Item 1) [C] must be tightened to 40–50 ft.-lbs. (54–68 Nm) torque.

### Raising The Operator Cab

Stop the loader on a level surface. Put the lift arms all the way down.

Open the rear door.

If the lift arms must be up while raising the cab, install the lift arm support device. (See Page 1-7.)

Remove the two fasteners and washers from the front corners of the operator cab (Item 1) [C].

Stand on the ground. Lift slowly until operator cab is all the way up [D].

The operator cab will lock in the raised position.

## OPERATOR CAB (Cont'd)

### Lowering The Operator Cab

Hold the operator cab. Release the locking mechanism by pushing the lever (Item 1) [A] inward from the locked position (Item 2) [A] and turning the lever until it stays in the unlocked position [B].



REMOVE YOUR HAND FROM THE HOLE BEFORE LOWERING THE OPERATOR CAB

Stand on the ground and pull down on the operator cab.

Avoid slippery surfaces when lowering the cab.

**NOTE:** Guide the operator cab over the fastening bolts to prevent thread damage.

Install the cab washers and nuts. Tighten the nuts (Item 1) [C] (both sides) to 40–50 ft.-lbs. (54–68 Nm) torque.

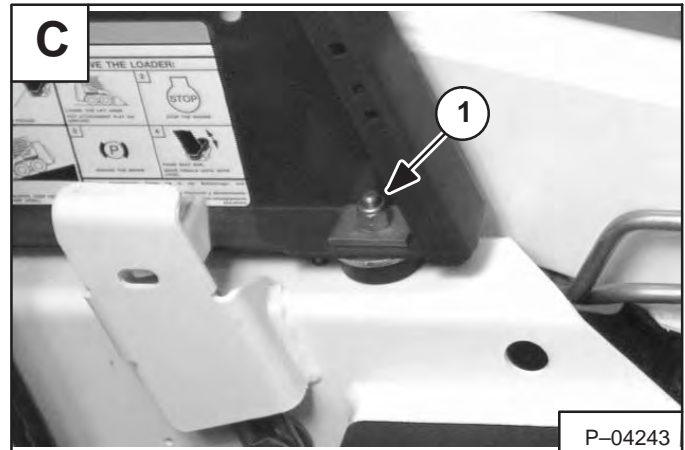
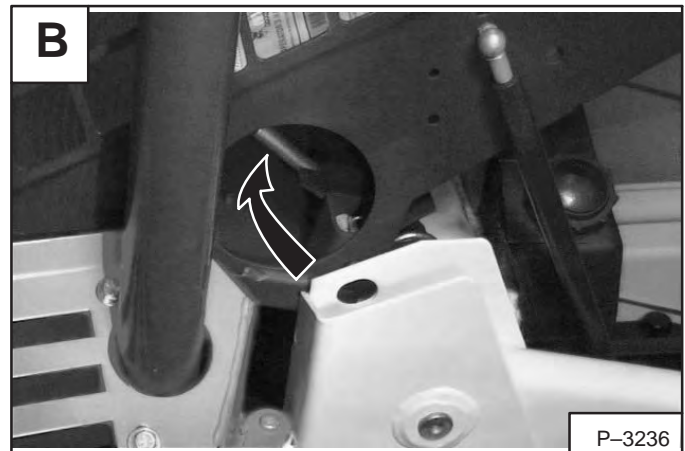
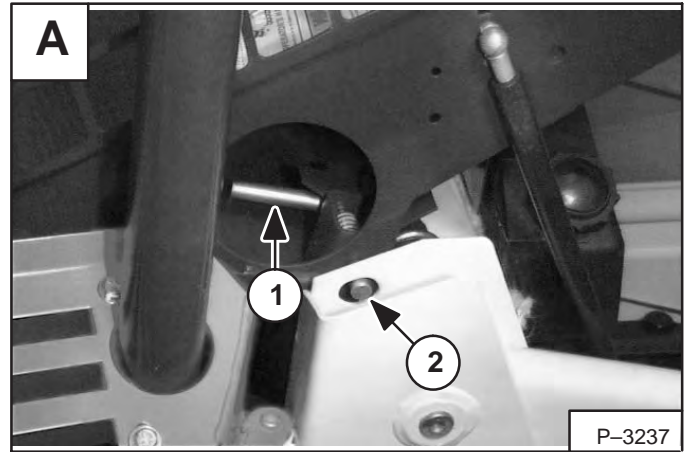

## SEAT BAR RESTRAINT SYSTEM

The seat bar restraint system has a pivoting seat bar with arm rests and has spring loaded interlocks for the lift and tilt control pedals. The operator controls the use of the seat bar. The seat bar in the down position helps to keep the operator in the seat. The interlocks require the operator to lower the seat bar in order to operate the foot pedal controls. When the seat bar is up, the lift and tilt pedals are locked when returned to the neutral position.



# WARNING

## AVOID INJURY OR DEATH

The seat bar system must lock the lift and tilt control pedals in neutral when the seat bar is up. Service the system if pedals do not lock correctly.

W-2105-1285

### Seat Bar Inspection

Sit in the seat and fasten the seat belt. Engage the parking brake. Pull the seat bar all the way down. Start the engine.

Operate each foot pedal to check both the lift and tilt functions.

Raise the lift arms until the bucket is about 2 feet (600 mm) off the ground. Raise the seat bar, try to move each pedal. The pedals must be firmly locked in neutral position. There must be no motion of the tilt (bucket) or the lift arms when the pedals are pushed.

Pull the seat bar down, lower the lift arms. Operate the lift pedals. While the lift arms are going up, raise the seat bar and the lift arms should stop.

Lower the seat bar, lower the lift arms and put the bucket flat on the ground. Stop the engine. Raise the seat bar and operate the foot pedals to be sure that the pedals are firmly locked in the neutral position. Unbuckle the seat belt.

### Seat Bar Maintenance

See the Service Schedule Page 1-3 and located on the loader rear door for correct service interval.

Clean any debris or dirt from the moving parts [A] & [B].

Inspect the linkage bolts and nuts for tightness. The correct torque is 25-28 ft.-lbs. (34-38 Nm).

If the seat bar system does not function correctly, check for free movement of each linkage part. Check for excessive wear. Adjust pedal control linkage. Replace parts that are worn or damaged. Use only genuine Melroe replacement parts.

### Foot Pedal Clean Out

Clean any debris from the holes (Item 1) [C] below the foot pedals as needed.

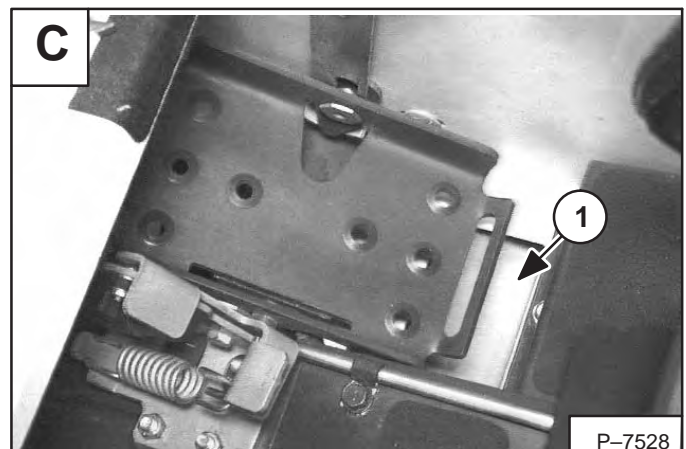
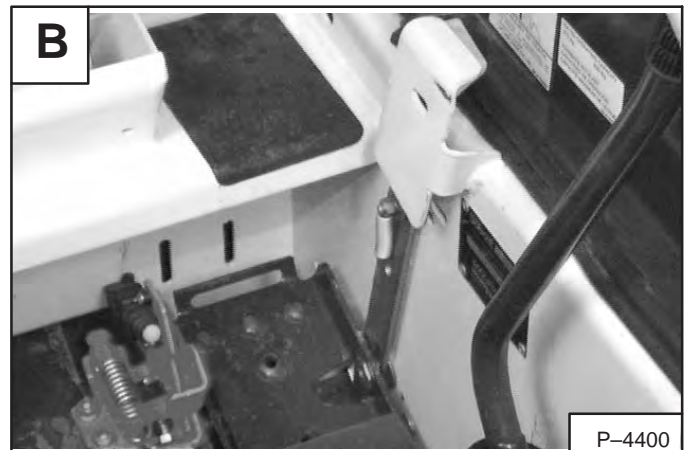
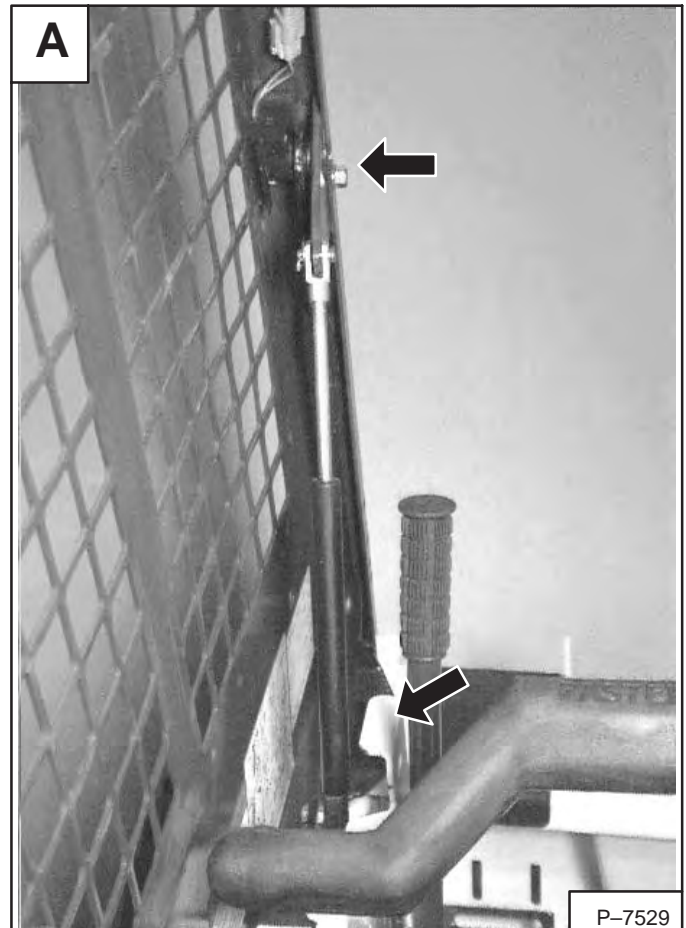

## AIR CLEANER SERVICE

### 450 Loader:

See the *SERVICE SCHEDULE* Page 1–3 for the interval to service the air cleaner system.

To replace or service the air cleaner element, use the following procedure:

Loosen the wing nuts (Item 1) **[A]**.

Remove the dust cover.

Remove the rubber bushings (Item 1) **[B]** and remove the air filter element **[B]**.

Clean the inside of the air cleaner housing so that the element will seal on a good surface.

Remove the foam precleaner from the paper element **[C]**. Wash the foam precleaner in clean solvent.

Install the foam precleaner on the new filter element. Install the dust cover and tighten the wing nut.

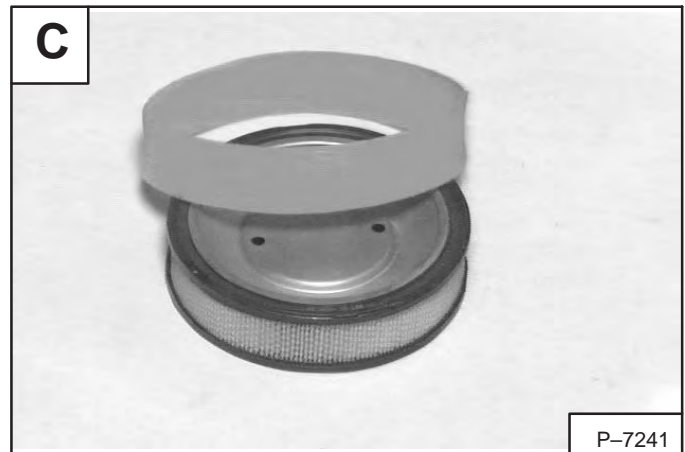
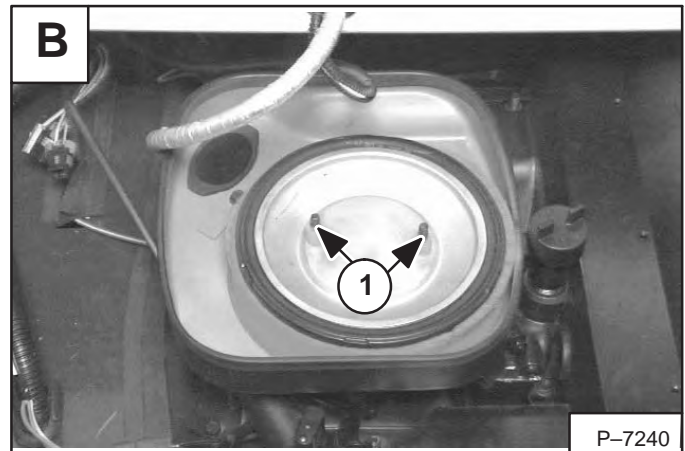
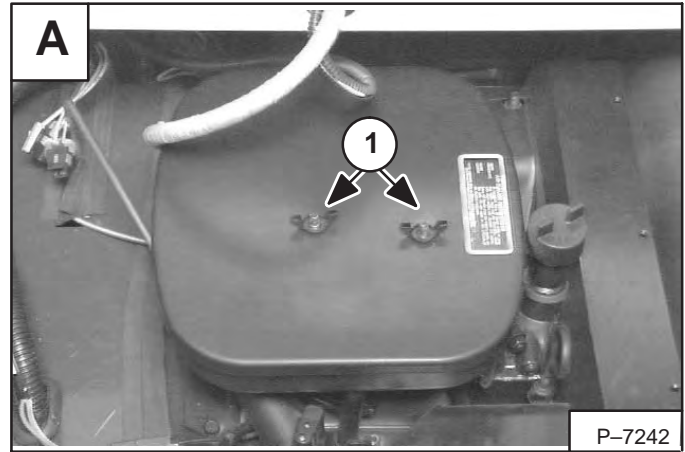

## AIR CLEANER SERVICE (Cont'd)

### 453 Loader:

See the *SERVICE SCHEDULE* Page 1–3 for the interval to service the air cleaner system.

Check the air intake hose for damage. Check the air cleaner housing for damage. Check to make sure all connections are tight.

Service the air cleaner as follows:

Loosen the wing nut (Item 1) [A].

Remove the cover (Item 1) [B], remove the dust cup (Item 2) [B]. Empty the debris from the dust cover.

Remove the wing nut (Item 3) [B] from the air filter.

Remove the air filter [C].

**NOTE:** Make sure all sealing surfaces are free of dirt and debris.

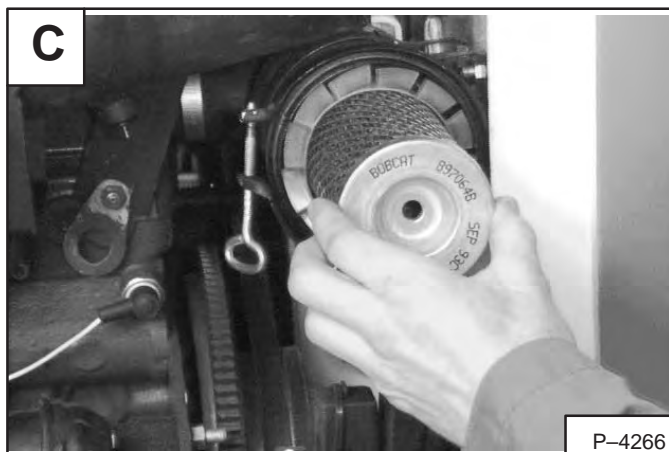
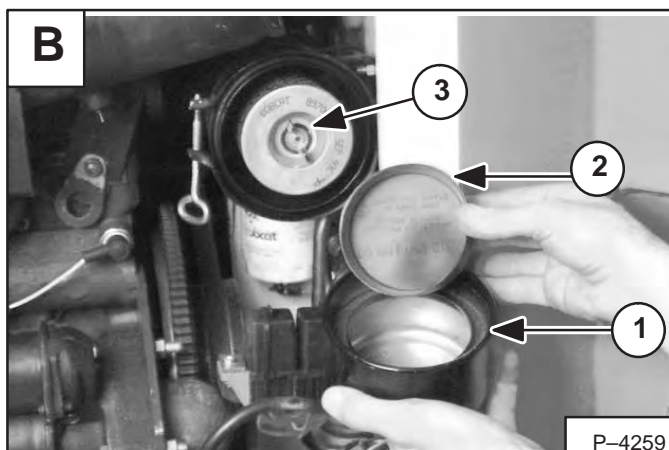
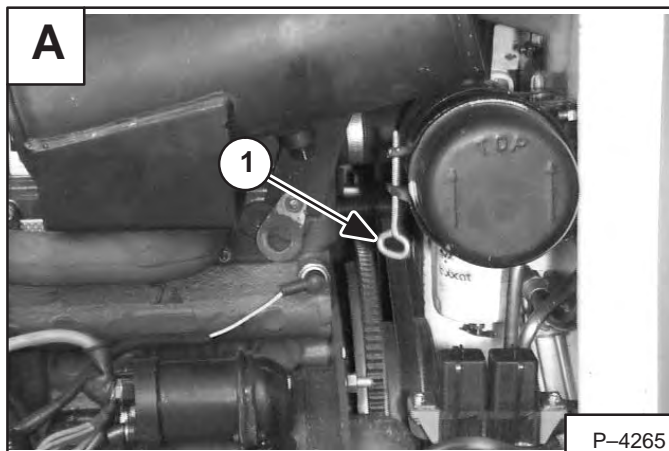

## FUEL SYSTEM

### 450 Loader:

#### Fuel Specifications

Use 87 octane regular gasoline or unleaded gasoline in the Kohler engine.

Gasohol (up to 10% ethyl alcohol, 90% unleaded gasoline by volume) is approved fuel for the Kohler engine.

## WARNING

Stop and cool the engine before adding fuel. **NO SMOKING!** Failure to obey warnings can cause an explosion or fire.

W-2063-0887

## WARNING

Always clean up spilled fuel or oil. Keep heat, flames, sparks or lighted tobacco away from fuel and oil. Failure to use care around combustibles can cause explosion or fire which can result in injury or death.

W-2103-1285

The fuel gauge (Item 1) [A] is located on the right side of the loader.

#### Filling The Fuel Tank

Remove the fuel fill cap (Item 1) [B].

Use a clean, approved safety container to add fuel.

The key switch must be in the OFF position and the engine cool.

Add fuel only in an area that has a free movement of air and no open flames or sparks. **NO SMOKING!** [C].

After the fuel tank is full, install the fill cap and tighten.

Check that the fuel gauge (Item 1) [D] works correctly.

#### Fuel Filter

See the *SERVICE SCHEDULE* Page 1-3 for the interval to service the fuel filter.

Raise the operator's cab. (See Page 1-9.)

Remove the fuel filter (Item 2) [D] and replace with a new filter. Make sure all the connections are tight.

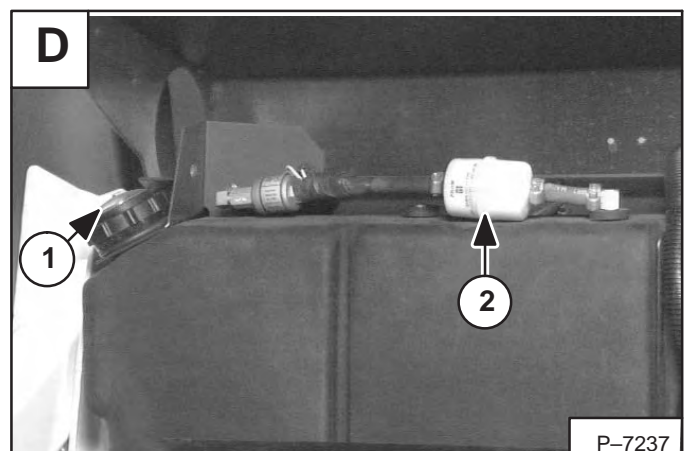
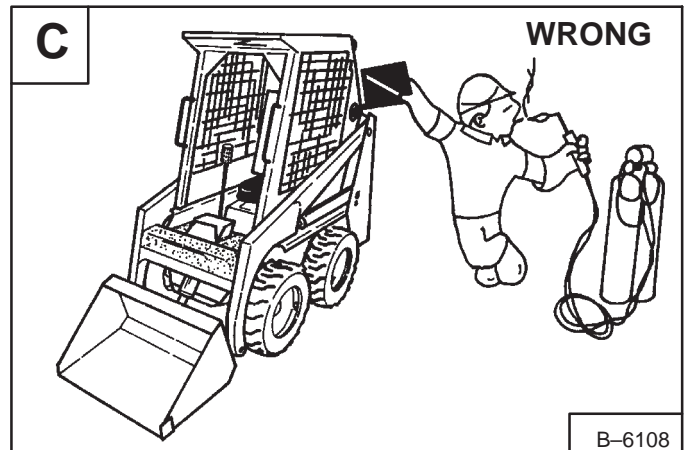
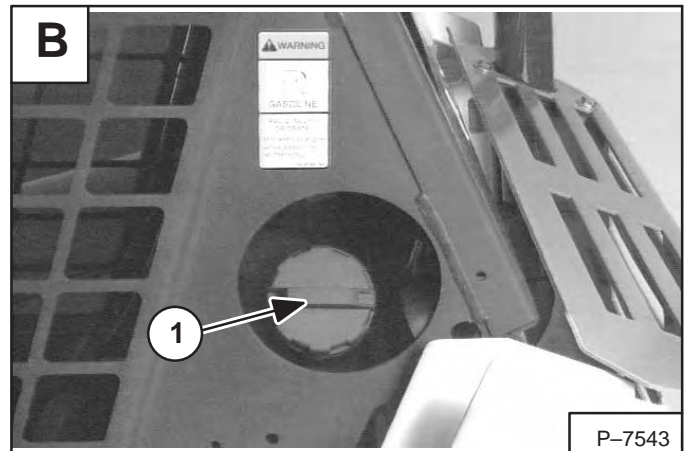
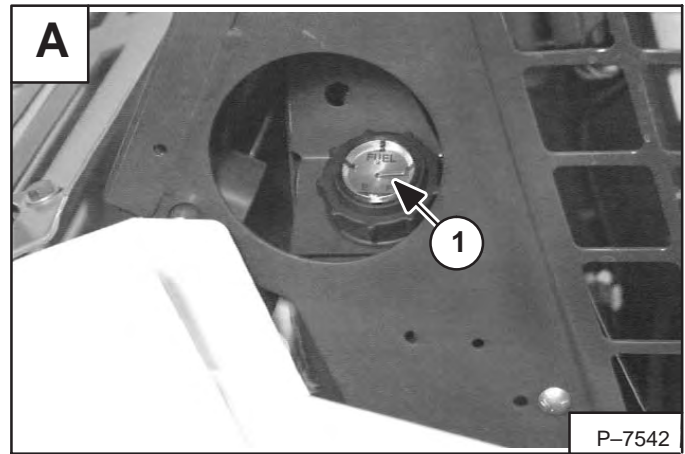

## FUEL SYSTEM (Cont'd)

### 453 Loader:

#### Fuel Specifications

Use only clean, high quality diesel fuel, Grade No. 1 or Grade No. 2.

The following is one suggested blending guideline which should prevent fuel gelling problems:

Temp. F°/C°	No. 2	No. 1
+15°(-9°)	100%	0%
Down to -20°/-29°	50%	50%
Below -20°/-29°	0%	100%

We recommend an operator contact their fuel supplier for local recommendations.

The fuel gauge (Item 1) [A] and the fuel shut off valve (Item 2) [A] are located on the right side of the loader.

#### Filling the Fuel Tank

## WARNING

Stop and cool the engine before adding fuel. NO SMOKING! Failure to obey warnings can cause an explosion or fire.

W-2063-0887

Always clean up spilled fuel or oil. Keep heat, flames, sparks or lighted tobacco away from fuel and oil. Failure to use care around combustibles can cause explosion or fire which can result in injury or death.

W-2103-1285

Remove the fuel fill cap (Item 1) [B].

Use a clean, approved safety container to add fuel of the correct specifications. Add fuel only in an area that has free movement of air and no open flames or sparks. NO SMOKING [B].

Install and tighten the fuel fill cap (Item 1) [B].

#### Fuel Filter

See the Service Schedule Page 1-3 for the service interval when to remove the water from the fuel filter.

Turn the fuel shut-off valve (Item 2) [A] clockwise to shut-off the fuel supply.

Loosen the drain (Item 1) [D] at the bottom of the filter element to drain the water from the filter.

Open the shut-off valve (Item 2) [A].

See the Service Schedule Page 1-3 for the service interval when to replace the fuel filter.

Clean the area around the fuel filter. Close the shut-off valve [A].

Remove the fuel filter [D].

**NOTE: Be sure the filter gasket is removed with the old fuel filter.**

Install the new filter element.

Open the shut-off valve [A].

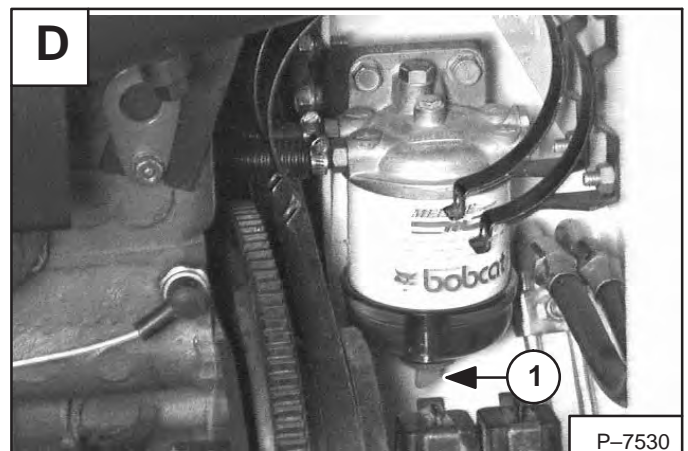
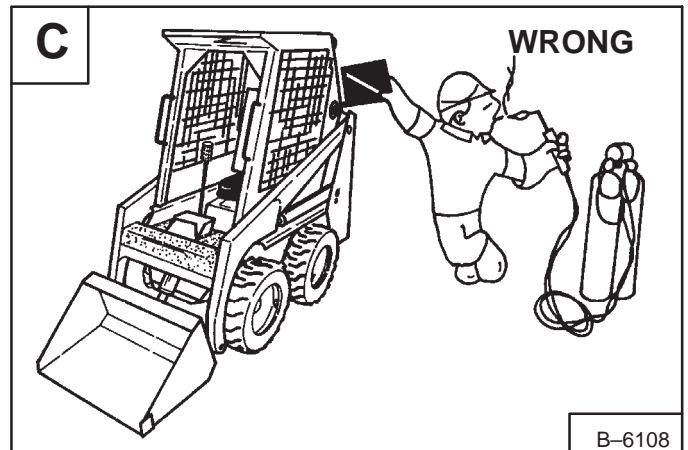
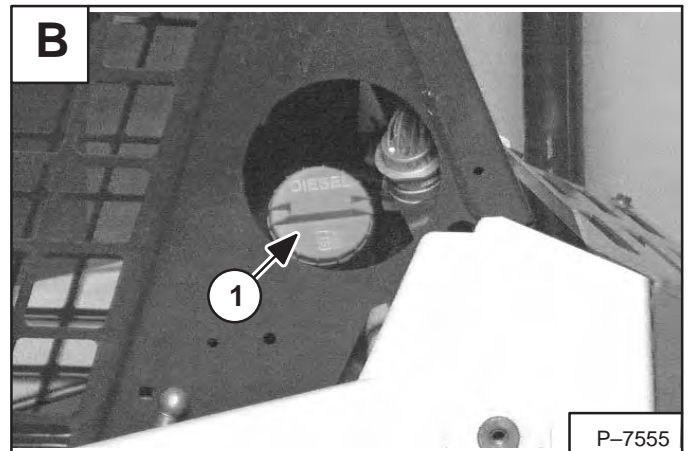
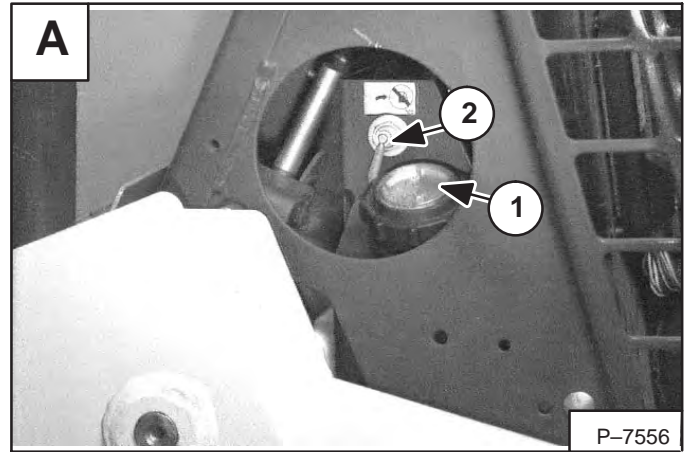

## FUEL SYSTEM (Cont'd)

### 453 Loader:

#### Removing Air From The Fuel System

After replacing the fuel filter element or when the fuel tank has run out of fuel, the air must be removed from the fuel system before starting the engine.

Open the rear door. The engine must be cool.

Open the vent plug (Item 1) [A].

Operate the hand pump (Item 1) [B] until fuel flows from the vent plug with no air bubbles.

Tighten the vent plug.

Operate the hand pump until it feels solid [B].

Move the engine speed control to minimum RPM. Open the valve (Item 1) [C] and squeeze the hand pump several times.

Start the engine. When the engine runs smoothly, close the valve (Item 1) [C].

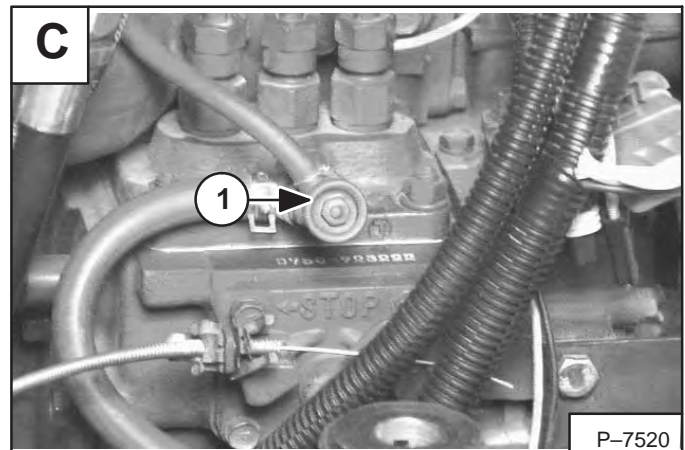
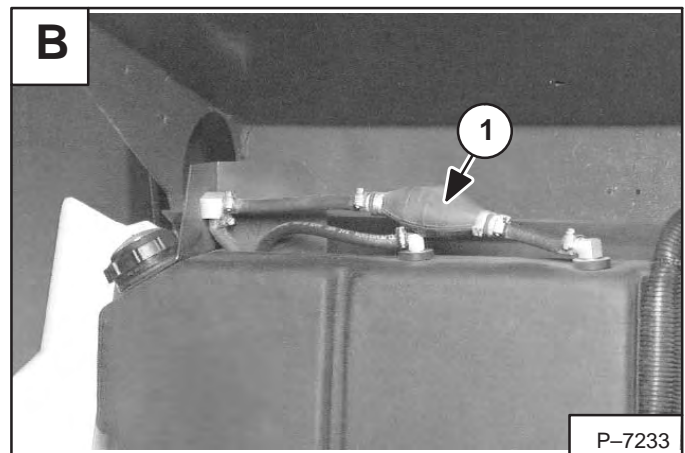
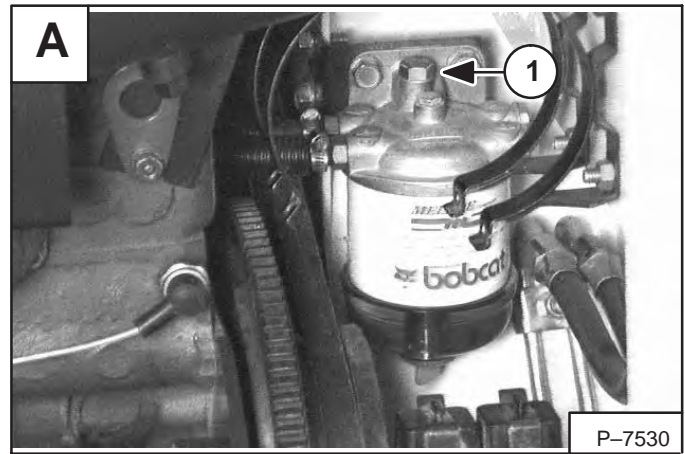

## **WARNING**

Always clean up spilled fuel or oil. Keep heat, flames, sparks or lighted tobacco away from fuel and oil. Failure to use care around combustibles can cause explosion or fire which can result in injury or death.

W-2103-1285



**Dear**

**Thanks very much for your visiting and  
patience.**

**Want to get more information,**

**Please click here, Go back to the page.**

**After your payment, you will have instant access to  
your download.**

**The Download Link will also be sent to your e-mail.**

**You will get the complete manual**

**Have any questions**

**please write to me**

**[admin@servicemanualperfect.com](mailto:admin@servicemanualperfect.com)**