

STX30, STX38, and STX46 Lawn Tractors



TECHNICAL MANUAL

**John Deere
Worldwide Commercial and
Consumer Equipment Division**

**TM1561 (15Mar97)
Replaces TM1561 (01Sep95) and
TM1418 (26Oct92)**

Litho in U.S.A



STX38 Gear Drive



STX38 Hydrostatic Drive



STX38 Motorsport Edition



STX46 Gear Drive



STX46 Hydrostatic Drive

This technical manual is written for an experienced technician and contains sections that are specifically for this product. It is a part of a total product support program.

The manual is organized so that all the information on a particular system is kept together. The order of grouping is as follows:

- Table of Contents
- Specifications
- Theory of Operation
- Troubleshooting Diagram
- Diagnostics
- Tests & Adjustments
- Repair

Note: Depending on the particular section or system being covered, not all of the above groups may be used.

Each section will be identified with a symbol rather than a number. The groups and pages within a section will be consecutively numbered.

All information, illustrations and specifications in this manual are based on the latest information available at the time of publication. The right is reserved to make changes at any time without notice.

We appreciate your input on this manual. To help, there are postage paid post cards included at the back. If you find any errors or want to comment on the layout of the manual please fill out one of the cards and mail it back to us.



COPYRIGHT© 1997
JOHN DEERE HORICON WORKS
Horicon, Wisconsin
All rights reserved



RECOGNIZE SAFETY INFORMATION



This is the safety-alert symbol. When you see this symbol on your machine or in this manual, be alert to the potential for personal injury.

Follow recommended precautions and safe servicing practices.

Understand Signal Words

A signal word—DANGER, WARNING, or CAUTION—is used with the safety-alert symbol. DANGER identifies the most serious hazards.

DANGER or WARNING safety signs are located near specific hazards. General precautions are listed on CAUTION safety signs. CAUTION also calls attention to safety messages in this manual.

REPLACE SAFETY SIGNS



Replace missing or damaged safety signs. See the machine operator's manual for correct safety sign placement.

HANDLE FLUIDS SAFELY-AVOID FIRES

Be Prepared For Emergencies

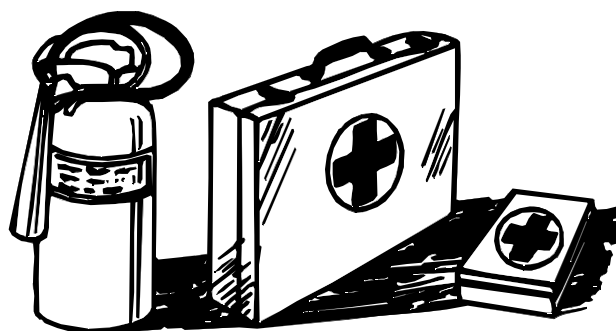

When you work around fuel, do not smoke or work near heaters or other fire hazards.

Store flammable fluids away from fire hazards. Do not incinerate or puncture pressurized containers.

Make sure machine is clean of trash, grease, and debris.

Do not store oily rags; they can ignite and burn spontaneously.

Be prepared if a fire starts.

Keep a first aid kit and fire extinguisher handy.

Keep emergency numbers for doctors, ambulance service, hospital, and fire department near your telephone.

**Thanks very much for your reading,
Want to get more information,
Please click here, Then get the complete
manual**

JustClickHere 

NOTE:

**If there is no response to click on the link above,
please download the PDF document first, and then
click on it.**

**Have any questions please write to me:
admin@servicemanualperfect.com**

USE CARE IN HANDLING AND SERVICING BATTERIES

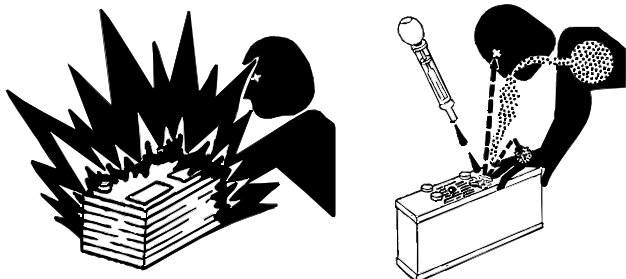

Prevent Battery Explosions

- Keep sparks, lighted matches, and open flame away from the top of battery. Battery gas can explode.
- Never check battery charge by placing a metal object across the posts. Use a volt-meter or hydrometer.
- Do not charge a frozen battery; it may explode. Warm battery to 16°C (60°F).

Prevent Acid Burns

- Sulfuric acid in battery electrolyte is poisonous. It is strong enough to burn skin, eat holes in clothing, and cause blindness if splashed into eyes.
- **Avoid acid burns by:**
 1. Filling batteries in a well-ventilated area.
 2. Wearing eye protection and rubber gloves.
 3. Avoiding breathing fumes when electrolyte is added.
 4. Avoiding spilling or dripping electrolyte.
 5. Use proper jump start procedure.
- **If you spill acid on yourself:**
 1. Flush your skin with water.
 2. Apply baking soda or lime to help neutralize the acid.
 3. Flush your eyes with water for 10_15 minutes.
 4. Get medical attention immediately.
- **If acid is swallowed:**
 1. Drink large amounts of water or milk.
 2. Then drink milk of magnesia, beaten eggs, or vegetable oil.
 3. Get medical attention immediately.

USE CARE AROUND HIGH-PRESSURE FLUID LINES



Avoid High-pressure Fluids

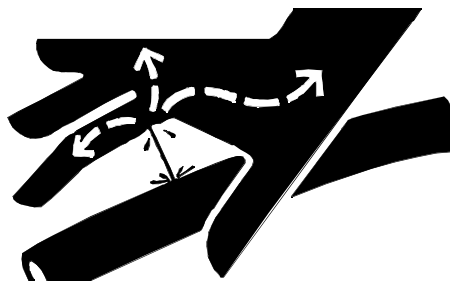

Escaping fluid under pressure can penetrate the skin causing serious injury.

Avoid injury from escaping fluid under pressure by stopping the engine and relieving pressure in the system before disconnecting or connecting hydraulic or other lines. Tighten all connections before applying pressure.

Search for leaks with a piece of cardboard. Protect hands and body from high pressure fluids.

If an accident occurs, see a doctor immediately. Any fluid injected into the skin must be surgically removed within a few hours or gangrene may result. Doctors unfamiliar with this type of injury should reference a knowledgeable medical source. Such information is available from Deere & Company Medical Department in Moline, Illinois, U.S.A.

Avoid Heating Near Pressurized Fluid Lines



Flammable spray can be generated by heating near pressurized fluid lines, resulting in severe burns to yourself and bystanders. Do not heat by welding, soldering, or using a torch near pressurized fluid lines or other flammable materials. Pressurized lines can be accidentally cut when heat goes beyond the immediate flame area.

SAFETY



USE SAFE SERVICE PROCEDURES

Wear Protective Clothing

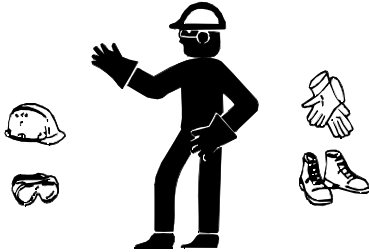

Wear close fitting clothing and safety equipment appropriate to the job.

Prolonged exposure to loud noise can cause impairment or loss of hearing. Wear a suitable hearing protective device such as earmuffs or earplugs to protect against objectionable or uncomfortable loud noises.

Operating equipment safely requires the full attention of the operator. Do not wear radio or music headphones while operating machine.

Service Machines Safely

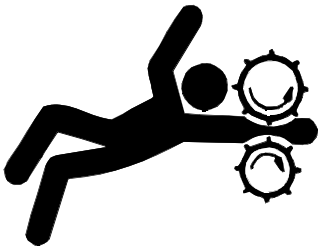

Tie long hair behind your head. Do not wear a necktie, scarf, loose clothing, or necklace when you work near machine tools or moving parts. If these items were to get caught, severe injury could result.

Remove rings and other jewelry to prevent electrical shorts and entanglement in moving parts.

Use Proper Tools

Use tools appropriate to the work. Makeshift tools and procedures can create safety hazards. Use power tools only to loosen threaded parts and fasteners. For loosening and tightening hardware, use the correct size tools. **DO NOT** use U.S. measurement tools on metric fasteners. Avoid bodily injury caused by slipping wrenches. Use only service parts meeting John Deere specifications.

Park Machine Safely

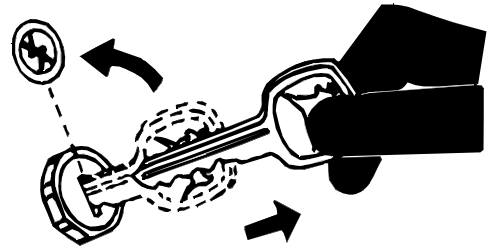

Before working on the machine:

1. Lower all equipment to the ground.
2. Stop the engine and remove the key.
3. Disconnect the battery ground strap.
4. Hang a "DO NOT OPERATE" tag in operator station.

Support Machine Properly And Use Proper Lifting Equipment

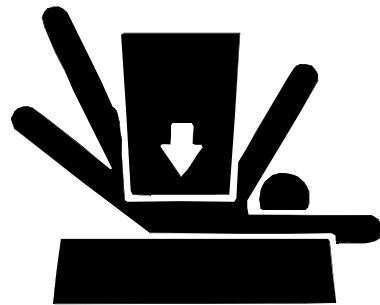

If you must work on a lifted machine or attachment, securely support the machine or attachment.

Do not support the machine on cinder blocks, hollow tiles, or props that may crumble under continuous load. Do not work under a machine that is supported solely by a jack. Follow recommended procedures in this manual.

Lifting heavy components incorrectly can cause severe injury or machine damage. Follow recommended procedure for removal and installation of components in the manual.

Work In Clean Area

Before starting a job:

1. Clean work area and machine.
2. Make sure you have all necessary tools to do your job.
3. Have the right parts on hand.
4. Read all instructions thoroughly; do not attempt shortcuts.

Using High Pressure Washers

Directing pressurized water at electronic/electrical components or connectors, bearings, hydraulic seals, fuel injection pumps or other sensitive parts and components may cause product malfunctions. Reduce pressure and spray at a 45 to 90 degree angle.

Illuminate Work Area Safely

Illuminate your work area adequately but safely. Use a portable safety light for working inside or under the machine. Make sure the bulb is enclosed by a wire cage. The hot filament of an accidentally broken bulb can ignite spilled fuel or oil.

Work In Ventilated Area

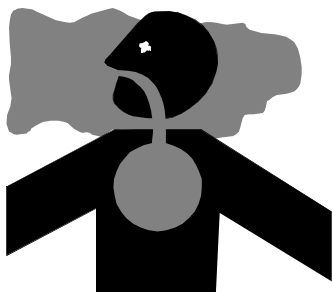

Engine exhaust fumes can cause sickness or death. If it is necessary to run an engine in an enclosed area, remove the exhaust fumes from the area with an exhaust pipe extension.

If you do not have an exhaust pipe extension, open the doors and get outside air into the area.

WARNING: California Proposition 65 Warning

Diesel engine exhaust and some of its constituents are known to the State of California to cause cancer, birth defects, and other reproductive harm.

Gasoline engine exhaust from this product contains chemicals known to the State of California to cause cancer, birth defects, or other reproductive harm.

Remove Paint Before Welding Or Heating

Avoid potentially toxic fumes and dust. Hazardous fumes can be generated when paint is heated by welding, soldering, or using a torch. Do all work outside or in a well ventilated area. Dispose of paint and solvent properly. Remove paint before welding or heating: If you sand or grind paint, avoid breathing the dust. Wear an approved respirator. If you use solvent or paint stripper, remove stripper with soap and water before welding. Remove solvent or paint stripper containers and other flammable material from area. Allow fumes to disperse at least 15 minutes before welding or heating.

Avoid Harmful Asbestos Dust

Avoid breathing dust that may be generated when handling components containing asbestos fibers. Inhaled asbestos fibers may cause lung cancer.

Components in products that may contain asbestos fibers are brake pads, brake band and lining assemblies, clutch plates, and some gaskets. The asbestos used in these components is usually found in a resin or sealed in some way. Normal handling is not hazardous as long as airborne dust containing asbestos is not generated.

Avoid creating dust. Never use compressed air for cleaning. Avoid brushing or grinding material containing asbestos. When servicing, wear an approved respirator. A special vacuum cleaner is recommended to clean asbestos. If not available, apply a mist of oil or water on the material containing asbestos. Keep bystanders away from the area.



SERVICE TIRES SAFELY



Explosive separation of a tire and rim parts can cause serious injury or death.

Do not attempt to mount a tire unless you have the proper equipment and experience to perform the job. Always maintain the correct tire pressure. Do not inflate the tires above the recommended pressure. Never weld or heat a wheel and tire assembly. The heat can cause an increase in air pressure resulting in a tire explosion. Welding can structurally weaken or deform the wheel.

When inflating tires, use a clip-on chuck and extension hose long enough to allow you to stand to one side and NOT in front of or over the tire assembly. Use a safety cage if available.

Check wheels for low pressure, cuts, bubbles, damaged rims or missing lug bolts and nuts.



AVOID INJURY FROM ROTATING BLADES, AUGERS AND PTO SHAFTS

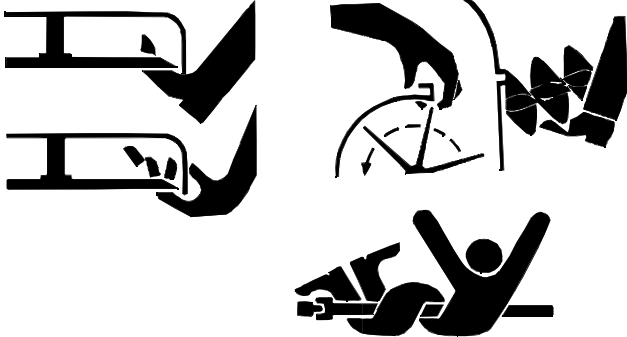

Keep hands and feet away while machine is running. Shut off power to service, lubricate or remove mower blades, augers or PTO shafts.

SERVICE COOLING SYSTEM SAFELY



Explosive release of fluids from pressurized cooling system can cause serious burns.

Shut off machine. Only remove filler cap when cool enough to touch with bare hands. Slowly loosen cap to first stop to relieve pressure before removing completely.

HANDLE CHEMICAL PRODUCTS SAFELY

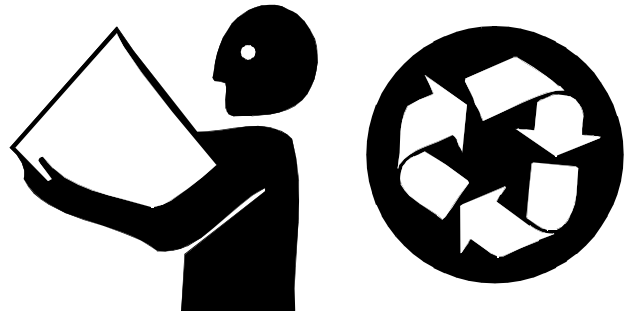

Direct exposure to hazardous chemicals can cause serious injury. Potentially hazardous chemicals used with John Deere equipment include such items as lubricants, coolants, paints, and adhesives.

A Material Safety Data Sheet (MSDS) provides specific details on chemical products: physical and health hazards, safety procedures, and emergency response techniques. Check the MSDS before you start any job using a hazardous chemical. That way you will know exactly what the risks are and how to do the job safely. Then follow procedures and recommended equipment.

Dispose of Waste Properly

Improperly disposing of waste can threaten the environment and ecology. Potentially harmful waste used with John Deere equipment include such items as oil, fuel, coolant, brake fluid, filters, and batteries. Use leakproof containers when draining fluids. Do not use food or beverage containers that may mislead someone into drinking from them. Do not pour waste onto the ground, down a drain, or into any water source. Inquire on the proper way to recycle or dispose of waste from your local environmental or recycling center, or from your John Deere dealer.

LIVE WITH SAFETY



Before returning machine to customer, make sure machine is functioning properly, especially the safety systems. Install all guards and shields.

CONTENTS

Page



SPECIFICATIONS & INFORMATION

GENERAL VEHICLE SPECIFICATIONS	3
METRIC FASTENER TORQUE VALUES	6
METRIC FASTENER TORQUE VALUE - GRADE 7	7
INCH FASTENER TORQUE VALUES	8
O-RING SEAL SERVICE RECOMMENDATIONS	9
FACE SEAL FITTINGS WITH INCH STUD ENDS TORQUE	9
FACE SEAL FITTINGS WITH METRIC STUD ENDS TORQUE	10
O-RING FACE SEAL FITTINGS	11
O-RING BOSS FITTINGS	11
GASOLINE SPECIFICATIONS	12
4-CYCLE ENGINES - NORTH AMERICA	12
GASOLINE STORAGE	12
4-CYCLE ENGINES - EUROPE	13
GASOLINE STORAGE	13
4-CYCLE GASOLINE ENGINE OIL	14
4-CYCLE GASOLINE ENGINE OIL - NORTH AMERICA	14
4-CYCLE GASOLINE ENGINE OIL - EUROPE	15
BREAK-IN 4-CYCLE GASOLINE ENGINE OIL - NORTH AMERICA	16
BREAK-IN 4-CYCLE GASOLINE ENGINE OIL - EUROPE	17
HYDROSTATIC TRANSMISSION OIL	18
HYDROSTATIC TRANSMISSION OIL - NORTH AMERICA	18
HYDROSTATIC TRANSMISSION OIL - EUROPE	19
ALTERNATIVE LUBRICANTS	20
SYNTHETIC LUBRICANTS	20
LUBRICANT STORAGE	20
MIXING OF LUBRICANTS	20
OIL FILTERS	20
GEAR TRANSMISSION GREASE	21
ANTI-CORROSION GREASE SPECIFICATIONS	22
GREASE SPECIFICATIONS	23
GREASE - NORTH AMERICA	23
GREASE - EUROPE	23
SERIAL NUMBER LOCATIONS	24
ENGINE SERIAL NUMBER SUFFIX	24
TRACTOR IDENTIFICATION NUMBER	24
ENGINE SERIAL NUMBER	24
GEAR TRANSAXLE SERIAL NUMBER	24
HYDROSTATIC TRANSMISSION SERIAL NUMBER	24



GENERAL VEHICLE SPECIFICATIONS

Engine:

Make Kohler
 Style Command LT
 STX30 CV12.5—1216s
 STX38 (Serial No. —270000) CV12.5—1215
 STX38 (Serial No. 210001—270000) CV12.5—1270
 STX38 (Serial No. 270001—595000 & Motorsport) CV13S—21509
 STX46 (Serial No. 210001—595000) CV14S—1463
 STX46 (Serial No. 270001—595000) CV15S—41521
 Type Gasoline, Air Cooled, Single Cylinder, 4-Cycle, Overhead Valves
 Crankcase Oil Capacity (with filter) 1.8 L (1.9 U.S. qt)
 Oil Type: (Warm Climate) 10W30
 (Cold Climate) 5W30

Electrical:

Charging System Flywheel/Electronic Magneto
 Magneto Air Gap 0.2—0.3 mm (0.008—0.012 in.)
 Charging Capacity 15 amp (regulated)
 Spark Plug Champion RC12YC
 Spark Plug Air Gap 1.0 mm (0.040 in.)
 Battery Type BCI Group, U1
 Battery Reserve Capacity 23 min. at 25 amp
 Battery Cold Cranking Amp 25 amp at 27° C (0° F) for 20 minutes
 Battery Specific Gravity Above 1.225 Points
 Starter Type Bendix Inertia Drive
 PTO Clutch Type Electric (Manufactured by Warner)
 Fuel Shut-Off Solenoid (Optional) Replaceable (Below Carburetor Float Bowl)
 Headlight Kit (Optional) Two Bulbs—Each 12 Volt/23W/1.9 Amp Draw

Fuel/Air System:

Carburetor Make Walbro
 Carburetor Type Side Draft
 Throttle/Choke Unitized Control Linkage
 Carburetor Fuel Shut-Off Solenoid (Optional) Electric
 Fuel Delivery Gravity Flow
 Fuel Filter Replaceable Paper (in-line type)
 Fuel Type Unleaded (87 octane minimum)
 Fuel Tank Capacity 4.7 L (1.25 gal)
 Air Filter Paper Element with Foam Pre-cleaner
 Muffler Type Anti-Backfire

Power Train:

Gear Transaxle—

Make Dana
 Model Spicer Heavy-Duty 4360 Transaxle
 Type Five-Speed/Linear Shift
 Domestic Ground Speeds (at FAST idle—3350 rpm) and Gear Ratios:
 1st Gear . (STX30 & STX38 SN —210000 2.2km/hr) 2.4 km/hr (1.5 mph)—61.67:1
 2nd Gear 3.2 km/hr (2.0 mph)—46.67:1
 3rd Gear . (STX30 & STX38 SN —210000 4.5km/hr) 5.0 km/hr (3.1 mph)—30.00:1
 4th Gear . (STX30 & STX38 SN —210000 5.7km/hr) 6.4 km/hr (4.0 mph)—23.48:1
 5th Gear . (STX30 & STX38 SN —210000 8.5km/hr) 8.0 km/hr (5.0 mph)—15.71:1
 Reverse . (STX30 & STX38 SN —210000 3.3km/hr) 3.7 km/hr (2.3 mph)—40.00:1
 Export Ground Speeds (at FAST idle—3000 rpm) and Gear Ratios:
 1st Gear 1.97 km/hr (1.22 mph)—61.67:1
 2nd Gear 2.61 km/hr (1.67 mph)—46.67:1
 3rd Gear 4.07 km/hr (2.53 mph)—30.00:1
 4th Gear 5.18 km/hr (3.22 mph)—23.48:1
 5th Gear 7.76 km/hr (4.82 mph)—15.71:1
 Reverse 3.04 km/hr (1.89 mph)—40.00:1
 Brake Type Single, External Brake Disc With Dual Friction Pucks



Power Train: (Continued)

Lubrication—Input Shaft Needle Bearings Unirex® N3 Grease Only
 Lubrication—Transaxle Shell Darina® D Grease Only
 Capacity—Transaxle 0.64 kg (1.406 lbs)

Hydro Transaxle—

Make Kanzaki
 Model (STX38—early models) Tuff Torq® K50 Transaxle
 Model (STX38—late models) Tuff Torq® K55 Transaxle
 Model (STX46) Tuff Torq® K55 Transaxle
 Type Hydrostatic
 Domestic Ground Speeds (at FAST idle—3350 rpm):
 Forward 0—9.3 km/hr (0—5.8 mph)
 Reverse 0—4.7 km/hr (0—2.9 mph)
 Export Ground Speeds (at FAST idle—3000 rpm):
 Forward 0—7.75 km/hr (0—4.82 mph)
 Reverse 0—3.80 km/hr (0—2.36 mph)
 Brake Type Single, External Disc Brake With Friction Pucks
 Lubrication John Deere Plus-4 10W30 Engine Oil, Class CD
 Reservoir Internal
 Capacity 1.6 L (3.4 pt)

Traction Drive Belt:

Gear—

Actual effective length 2660±8 mm (104.7±0.3 in.)
 Theoretical effective length (short) 2631 mm (103.6 in.)
 Theoretical effective length (long) 2710 mm (106.7 in.)

Hydro—

Actual effective length 2485±8 mm (97.8±0.3 in.)
 Theoretical effective length (short) 2477 mm (97.5 in.)
 Theoretical effective length (long) 2530 mm (99.6 in.)

Mower Deck Drive Belt

38-Inch Deck—

Actual effective length 2425±10 mm (95.5±0.4 in.)

46-Inch Deck—

Actual effective length 3492±10 mm (137.5±0.4 in.)

Mower Deck:

38-Inch Mower Deck—

Type Rotary—Dual Spindles (Non-Serviceable)
 Material Type Stamped 2.5 mm (0.098 in.) Nominal Gauge Steel
 Cutting Blade Two—76 x 5 x 496 mm (3 x 0.2 x 19.5 in.)
 Blade Cutting Edge 30±5° Angle
 Blade Wing Lift/Height 40±3 mm (1.57±0.12 in.)
 Overall Cutting Width 965 mm (38 in.)
 Overall Width (w/o discharge chute) 1026 mm (40.4 in.)
 Drive Type Single V-Belt (with spring-tensioned idler)
 Spindle Lubrication None—Sealed Bearings
 Lift Type Manual—Operator’s Station
 Cutting Settings Seven: 31.8—89 mm (1.25—3.5 in.)

Mower Deck: (Continued)

46-Inch Mower Deck—

Type	Rotary—Triple Spindles (Non-Serviceable)
Material Type	Stamped 2.5 mm (0.098 in.) Nominal Gauge Steel
Cutting Blade	Three—50.8 x 5 x 407.4 mm (2 x 0.2 x 16 in.)
Blade Cutting Edge	30±5° Angle
Blade Wing Lift/Height	20.3±3 mm (0.8±0.12 in.)
Overall Cutting Width	1168.4 mm (46 in.)
Overall Width (w/o discharge chute)	1308 mm (51.5 in.)
Drive Type	Single V-Belt (with spring-tensioned idler)
Spindle Lubrication	None—Supplier Fill Only
Lift Type	Manual—Operator's Station
Cutting Settings	Seven: 31.75 mm—89 mm (1.25—3.5 in.)

Chassis:

Wheelbase	1135 mm (44.69 in.)
Overall Length	1524 mm (60 in.)
Overall Width (w/o mower deck)	908 mm (35.75 in.)
Height	980 mm (38.6 in.)
Average Overall Weight STX38 (with mower deck/no fuel)	195.05 kg (430 lbs)
Average Overall Weight STX46 (with mower deck/no fuel)	204.12 kg (450 lbs)
Hitch Capacity—	
Export:	
Horizontal Pull Maximum	250 N (56 lbs)
Tongue Weight Maximum	65 N (15 lbs)
Domestic:	
Trailer Load Maximum	136 kg (300 lbs)
Trailer Tongue Weight Maximum	23 kg (50 lbs)

Steering:

Type	Manual—Pinion/Sector
Axle Pivot Hub	Shim Adjustable
Lubrication	DuBois MPG-2® Multipurpose Grease
Lubrication Interval	10 hrs (maximum)
Toe-In	6 mm (0.24 in.) — Non-Adjustable
Turning Radius	584 mm (23 in.)

Wheels:

Size—	
Front	6.0 x 4.50
Rear	8.0 x 6.18

Tires:

Size—	
Front (STX30)	13 x 5—6 NHS (2 ply)
Rear (STX30)	18 x 6.50—8 NHS (2 ply)
Front (STX38 SN —210000)	13 x 6.50—6 NHS (2 ply)
Rear (STX38 SN —210000)	18 x 8.50—8 NHS (2 ply)
Front (STX38 SN 210001—270000)	13 x 6.50—6 NHS (2 ply)
Rear (STX38 SN 210001—270000)	18 x 9.50—8 NHS (2 ply)
Front (STX38 SN 270001—595000 & STX46)	15 x 6.50—6 NHS (2 ply)
Rear (STX38 SN 270001—595000 & STX46)	20 x 8.00—8 NHS (2 ply)
Pressure—	
Front (with mower deck)	83 kPa (12 psi)
Front (with snowthrower)	138 kPa (20 psi)
Rear (STX30 with mower deck)	97 kPa (14 psi)
Rear (with mower deck)	55 kPa (8 psi)



METRIC FASTENER TORQUE VALUES

Property Class and Head Markings	4.8	8.8	9.8	10.9	12.9
Property Class and Nut Markings	5	10	10	12	

TS1163

SIZE	Class 4.8		Class 8.8 or 9.8				Class 10.9				Class 12.9					
	Lubricated ^a		Dry ^a		Lubricated ^a		Dry ^a		Lubricated ^a		Dry ^a		Lubricated ^a		Dry ^a	
	N•m	lb-ft	N•m	lb-ft	N•m	lb-ft	N•m	lb-ft	N•m	lb-ft	N•m	lb-ft	N•m	lb-ft	N•m	lb-ft
M6	4.8	3.5	6	4.5	9	6.5	11	8.5	13	9.5	17	12	15	11.5	19	14.5
M8	12	8.5	15	11	22	16	28	20	32	24	40	30	37	28	47	35
M10	23	17	29	21	43	32	55	40	63	47	80	60	75	55	95	70
M12	40	29	50	37	75	55	95	70	110	80	140	105	130	95	165	120
M14	63	47	80	60	120	88	150	110	175	130	225	165	205	150	260	109
M16	100	73	125	92	190	140	240	175	275	200	350	225	320	240	400	300
M18	135	100	175	125	260	195	330	250	375	275	475	350	440	325	560	410
M20	190	140	240	180	375	275	475	350	530	400	675	500	625	460	800	580
M22	260	190	330	250	510	375	650	475	725	540	925	675	850	625	1075	800
M24	330	250	425	310	650	475	825	600	925	675	1150	850	1075	800	1350	1000
M27	490	360	625	450	950	700	1200	875	1350	1000	1700	1250	1600	1150	2000	1500
M30	675	490	850	625	1300	950	1650	1200	1850	1350	2300	1700	2150	1600	2700	2000
M33	900	675	1150	850	1750	1300	2200	1650	2500	1850	3150	2350	2900	2150	3700	2750
M36	1150	850	1450	1075	2250	1650	2850	2100	3200	2350	4050	3000	3750	2750	4750	3500

DO NOT use these hand torque values if a different torque value or tightening procedure is given for a specific application. Torque values listed are for general use only and include a ±10% variance factor. Check tightness of fasteners periodically. DO NOT use air powered wrenches.

Shear bolts are designed to fail under predetermined loads. Always replace shear bolts with identical grade.

Fasteners should be replaced with the same class. Make sure fastener threads are clean and that you properly start thread engagement. This will prevent them from failing when tightening.

When bolt and nut combination fasteners are used, torque values should be applied to the **NUT** instead of the bolt head.

Tighten toothed or serrated-type lock nuts to the full torque value.

^a "Lubricated" means coated with a lubricant such as engine oil, or fasteners with phosphate and oil coatings. "Dry" means plain or zinc plated (yellow dichromate - Specification JDS117) without any lubrication.











Reference: JDS—G200.

**METRIC FASTENER TORQUE
VALUE - GRADE 7**

Size	Steel or Gray Iron Torque		Aluminum Torque	
	N•m	lb-ft	N•m	lb-ft
M6	11	8	8	6
M8	24	18	19	14
M10	52	38	41	30
M12	88	65	70	52
M14	138	102	111	82
M16	224	165	179	132



INCH FASTENER TORQUE VALUES

SAE Grade and Head Markings	1 or 2 ^b No Marks 	5  5.1  5.2 	8  8.2 
	2 No Marks 	5  	8  

TS1162

SIZE	Grade 1		Grade 2 ^b		Grade 5, 5.1 or 5.2				Grade 8 or 8.2							
	Lubricated ^a		Dry ^a		Lubricated ^a		Dry ^a		Lubricated ^a		Dry ^a		Lubricated ^a		Dry ^a	
	N•m	lb-ft	N•m	lb-ft	N•m	lb-ft	N•m	lb-ft	N•m	lb-ft	N•m	lb-ft	N•m	lb-ft	N•m	lb-ft
1/4	3.7	2.8	4.7	3.5	6	4.5	7.5	5.5	9.5	7	12	9	13.5	10	17	12.5
5/16	7.7	5.5	10	7	12	9	15	11	20	15	25	18	28	21	35	26
3/8	14	10	17	13	22	16	27	20	35	26	44	33	50	36	63	46
7/16	22	16	28	20	35	26	44	32	55	41	70	52	80	58	100	75
1/2	33	25	42	31	53	39	67	50	85	63	110	80	120	90	150	115
9/16	48	36	60	45	75	56	95	70	125	90	155	115	175	130	225	160
5/8	67	50	85	62	105	78	135	100	170	125	215	160	215	160	300	225
3/4	120	87	150	110	190	140	240	175	300	225	375	280	425	310	550	400
7/8	190	140	240	175	190	140	240	175	490	360	625	450	700	500	875	650
1	290	210	360	270	290	210	360	270	725	540	925	675	1050	750	1300	975
1-1/8	470	300	510	375	470	300	510	375	900	675	1150	850	1450	1075	1850	1350
1-1/4	570	425	725	530	570	425	725	530	1300	950	1650	1200	2050	1500	2600	1950
1-3/8	750	550	950	700	750	550	950	700	1700	1250	2150	1550	2700	2000	3400	2550
1-1/2	1000	725	1250	925	990	725	1250	930	2250	1650	2850	2100	3600	2650	4550	3350

DO NOT use these hand torque values if a different torque value or tightening procedure is given for a specific application. Torque values listed are for general use only and include a ±10% variance factor. Check tightness of fasteners periodically. DO NOT use air powered wrenches.

Shear bolts are designed to fail under predetermined loads. Always replace shear bolts with identical grade.

Fasteners should be replaced with the same grade. Make sure fastener threads are clean and that you properly start thread engagement. This will prevent them from failing when tightening.

When bolt and nut combination fasteners are used, torque values should be applied to the **NUT** instead of the bolt head.

Tighten toothed or serrated-type lock nuts to the full torque value.

^a "Lubricated" means coated with a lubricant such as engine oil, or fasteners with phosphate and oil coatings. "Dry" means plain or zinc plated (yellow dichromate - Specification JDS117) without any lubrication.

^b "Grade 2" applies for hex cap screws (not hex bolts) up to 152 mm (6-in.) long. "Grade 1" applies for hex cap screws over 152 mm (6-in.) long, and for all other types of bolts and screws of any length.

Reference: JDS—G200.

O-RING SEAL SERVICE RECOMMENDATIONS

FACE SEAL FITTINGS WITH INCH STUD ENDS TORQUE

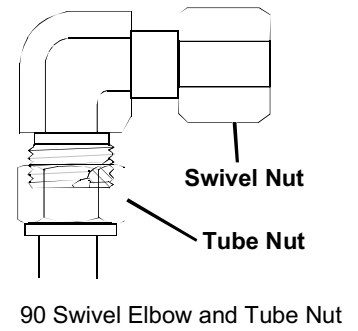
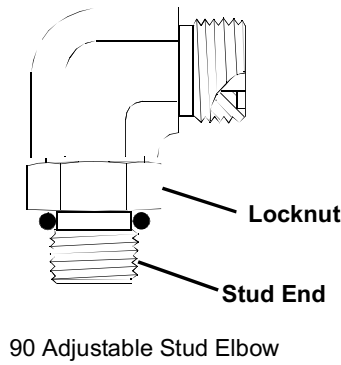
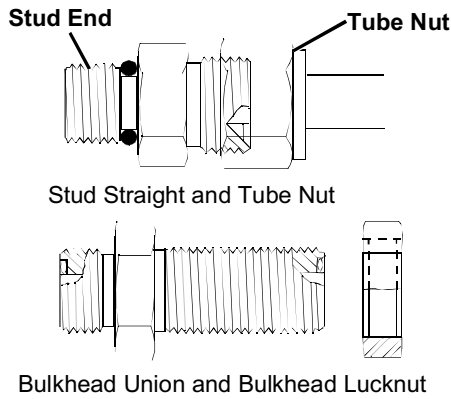

Nominal Tube O.D./Hose I.D.				Face Seal Tube/Hose End					O-ring Stud Ends		
Metric Tube O.D.	Inch Tube O.D.			Thread Size	Tube Nut/ Swivel Nut Torque		Bulkhead Locknut Torque		Thread Size	Straight Fitting or Locknut Torque	
	mm	Dash Size	in.		mm	in.	N•m	lb-ft		N•m	lb-ft
	-3	0.188	4.76						3/8-24	8	6
6	-4	0.250	6.35	9/16-18	16	12	12	9	7/16-20	12	9
8	-5	0.312	7.94						1/2-20	16	12
10	-6	0.375	9.52	11/16-16	24	18	24	18	9/16-18	24	18
12	-8	0.500	12.70	13/16-16	50	37	46	34	3/4-16	46	34
16	-10	0.625	15.88	1-14	69	51	62	46	7/8-14	62	46
	-12	0.750	19.05	1-3/16-12	102	75	102	75	1-1/16-12	102	75
22	-14	0.875	22.22	1-3/16-12	102	75	102	75	1-3/16-12	122	90
25	-16	1.000	25.40	1-7/16-12	142	105	142	105	1-5/16-12	142	105
32	-20	1.25	31.75	1-11/16-12	190	140	190	140	1-5/8-12	190	140
38	-24	1.50	38.10	2-12	217	160	217	160	1-7/8-12	217	160

NOTE: Torque tolerance is + 15 minus 20%.

FACE SEAL FITTINGS WITH METRIC STUD ENDS TORQUE

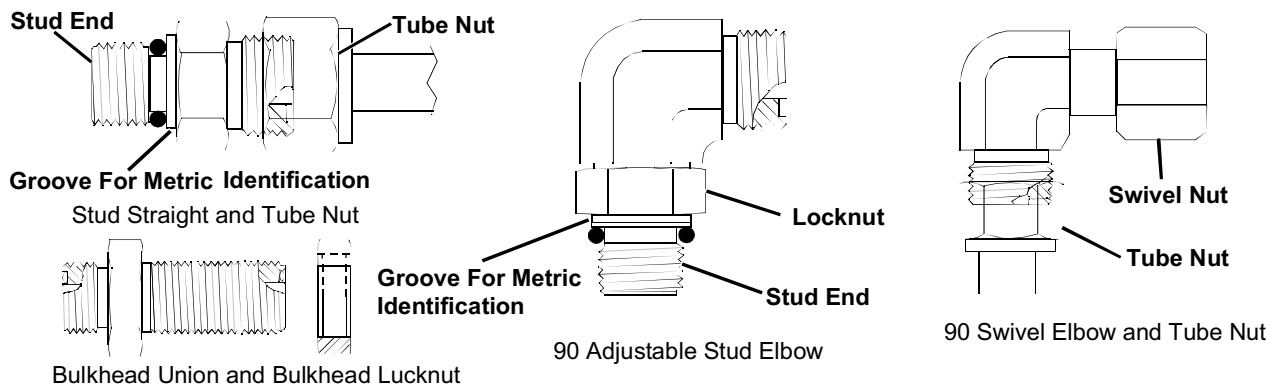

Nominal Tube O.D./Hose I.D.				Face Seal Tube/Hose End						O-ring Stud Ends, Straight Fitting or Locknut					
Metric Tube O.D.	Inch Tube O.D.			Thread Size	Hex Size	Tube Nut/ Swivel Nut Torque		Bulkhead Locknut Torque		Thread Size	Hex Size	Steel or Gray Iron Torque		Aluminum Torque	
	mm	Dash Size	in.			mm	in.	mm	N•m			lb-ft	N•m	lb-ft	mm
6	-4	0.250	6.35	9/16-18	17	16	12	12	9	M12X1.5	17	21	15.5	9	6.6
8	-5	0.312	7.94												
										M14X1.5	19	33	24	15	11
10	-6	0.375	9.52	11/16-16	22	24	18	24	18	M16X1.5	22	41	30	18	13
12	-8	0.500	12.70	13/16-16	24	50	37	46	34	M18X1.5	24	50	37	21	15
16	-10	0.625	15.88	1-14	30	69	51	62	46	M22X1.5	27	69	51	28	21
	-12	0.750	19.05	1-3/16-12	36	102	75	102	75	M27X2	32	102	75	46	34
22	-14	0.875	22.22	1-3/16-12	36	102	75	102	75	M30X2	36				
25	-16	1.000	25.40	1-7/16-12	41	142	105	142	105	M33X2	41	158	116	71	52
28										M38X2	46	176	130	79	58
32	-20	1.25	31.75	1-11/16-12	50	190	140	190	140	M42X2	50	190	140	85	63
38	-24	1.50	38.10	2-12	60	217	160	217	160	M48X2	55	217	160	98	72

NOTE: Torque tolerance is + 15 minus 20%.

O-RING FACE SEAL FITTINGS

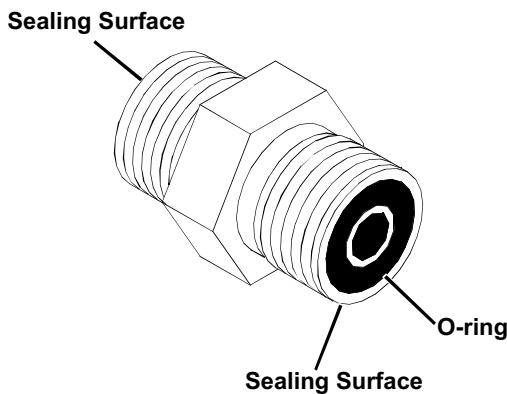

1. Inspect the fitting sealing surfaces. They must be free of dirt or defects.
2. Inspect the O-ring. It must be free of damage or defects.
3. Lubricate O-rings and install into groove using petroleum jelly to hold in place.
4. Push O-ring into the groove with plenty of petroleum jelly so O-ring is not displaced during assembly.
5. Index angle fittings and tighten by hand pressing joint together to insure O-ring remains in place.
6. Tighten fitting or nut to torque value shown on the chart per dash size stamped on the fitting. Do not allow hoses to twist when tightening fittings.

O-RING BOSS FITTINGS

1. Inspect boss O-ring boss seat. It must be free of dirt and defects. If repeated leaks occur, inspect for defects with a magnifying glass. Some raised defects can be removed with a slip stone.

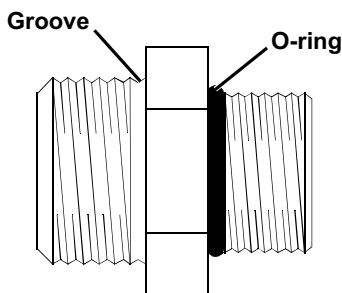

2. Put hydraulic oil or petroleum jelly on the O-ring. Place electrical tape over the threads to protect O-ring from nicks. Slide O-ring over the tape and into the groove of fitting. Remove tape.

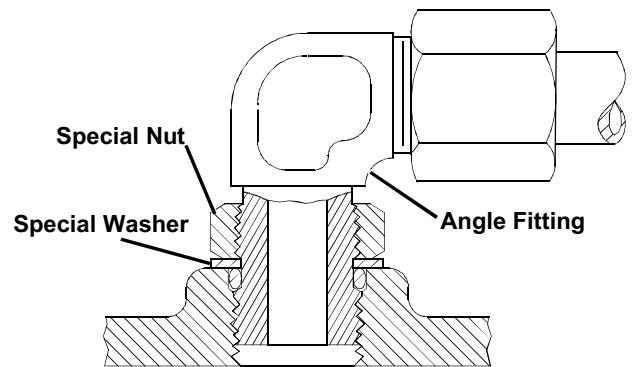

3. For angle fittings, loosen special nut and push special washer against threads so O-ring can be installed into the groove of fitting.
4. Turn fitting into the boss by hand until special washer or washer face (straight fitting) contacts boss face and O-ring is squeezed into its seat.
5. To position angle fittings, turn the fitting counter-clockwise a maximum of one turn.
6. Tighten straight fittings to torque value shown on chart. For angle fittings, tighten the special nut to value shown in the chart while holding body of fitting with a wrench.

STRAIGHT FITTING OR SPECIAL NUT TORQUE

Thread Size	Torque ^a		Number of Flats ^b
	N•m	lb-ft	
3/8-24 UNF	8	(6)	2
7/16-20 UNF	12	(9)	2
1/2-20 UNF	16	(12)	2
9/16-18 UNF	24	(18)	2
3/4-16 UNF	46	(34)	2
7/8-14 UNF	62	(46)	1-1/2
1-1/16-12 UN	102	(75)	1
1-3/16-12 UN	122	(90)	1
1-5/16-12 UN	142	(105)	3/4
1-5/8-12 UN	190	(140)	3/4
1-7/8-12 UN	217	(160)	1/2

a. Torque tolerance is ± 10 percent.

b. To be used if a torque wrench cannot be used. After tightening fitting by hand, put a mark on nut or boss; then tighten special nut or straight fitting the number of flats shown.