

**John Deere 410B,
410C, 510B, 510C
Backhoe Loaders
Repair**

**TECHNICAL
MANUAL**



TM-1469 (Dec-88)

LITHO IN U.S.A.

Introduction

FOREWORD

This manual is written for an experienced technician. Essential tools required in performing certain service work are identified in this manual and are recommended for use.

Live with safety: Read the safety messages in the introduction of this manual and the cautions presented throughout the text of the manual.



This is the safety-alert symbol. When you see this symbol on the machine or in this manual, be alert to the potential for personal injury.

Technical manuals are divided in two parts: repair and diagnostics. Repair sections tell how to repair the components. Diagnostic sections help you identify the majority of routine failures quickly.

Information is organized in groups for the various components requiring service instruction. At the beginning of each group are summary listings of all applicable essential tools, service equipment and tools, other materials needed to do the job, service parts kits, specifications, wear tolerances, and torque values.

Binders, binder labels, and tab sets can be ordered by John Deere dealers direct from the John Deere Distribution Service Center.

This manual is part of a total product support program.

FOS Manuals-reference

Technical Manuals-machine service

Component Manuals-component service

Fundamentals of Service (FOS) Manuals cover basic theory of operation, fundamentals of troubleshooting, general maintenance, and basic types of failures and their causes. FOS Manuals are for training new personnel and for reference by experienced technicians.

Technical Manuals are concise guides for specific machines. Technical manuals are on-the-job guides containing only the vital information needed for diagnosis, analysis, testing, and repair.

Component Technical Manuals are concise service guides for specific components. Component technicals manuals are written as stand-alone manuals covering multiple machine applications.

JOHN DEERE DEALERS

IMPORTANT: Please remove this page and route through your service department.

This is a complete revision for TM-1364, 410B/410C and 510B/510C Backhoe Loaders.

TM-1468 (Operation and Test) and TM-1469 (Repair) replace TM-1364.

The new pages are dated (Dec-88). Listed below is a brief explanation of "WHAT" was changed and "WHY" it was changed.

This manual was revised:

1. Update hydraulic cylinder torque-turn specifications.
2. New procedure for repair of axle and integral steering cylinder.
3. Update to include unitized stroke control valve on the 3000 series hydraulic pump.
4. Update repair section to utilize CTM's.
5. Update repair and adjustment procedure of cab windows.
6. Update electrical and hydraulic sections.

T64;TM1469 DCS 130289

**Thanks very much for your reading,
Want to get more information,
Please click here, Then get the complete
manual**

JustClickHere 

NOTE:

**If there is no response to click on the link above,
please download the PDF document first, and then
click on it.**

**Have any questions please write to me:
admin@servicemanualperfect.com**

410B AND 510B BACKHOE LOADER 410C AND 510C BACKHOE LOADER TECHNICAL MANUAL TM-1469 (DEC-88)

SECTION AND GROUP CONTENTS

NOTE: This manual covers machine repair. For Operation and Test information, see TM-1468.

SECTION I—GENERAL INFORMATION

- Group I—Introduction and Safety Information
- Group II—General Specifications
- Group III—Torque Values
- Group IV—Lubrication
- Group V—Inspection Procedures

SECTION 01—WHEELS

- Group 0110—Powered Wheels and Fastenings
- Group 0120—Non-Powered Wheels and Fastenings

SECTION 02—AXLES AND SUSPENSION SYSTEMS

- Group 0230—Non-Powered Wheel Axles
- Group 0250—Axle Shafts, Bearings and Reduction Gears

SECTION 03—TRANSMISSION

- Group 0300—Removal and Installation
- Group 0315—Controls
- Group 0325—Input Drive Shafts and U-Joints
- Group 0350—Gears, Shafts, Housings, Bearings, Differential Lock, Brake and Park Brake
- Group 0360—Hydraulic System, Control Valve, Suction Screen, Oil Pump, and Lubrication System

SECTION 04—ENGINE

- Group 0400—Removal and Installation
- Group 0413—Fuel Injection System
- Group 0414—Intake Manifold
- Group 0416—Turbocharger
- Group 0417—Water Pump
- Group 0418—Thermostats, Housing and Water Piping
- Group 0419—Oil Cooler
- Group 0420—Fuel Filter
- Group 0421—Fuel Transfer Pump
- Group 0422—Starting Motor and Fastenings

SECTION 05—ENGINE AUXILIARY SYSTEMS

- Group 0505—Cold Weather Starting Aids
- Group 0510—Cooling Systems
- Group 0515—Speed Controls
- Group 0520—Intake System
- Group 0560—External Fuel Supply Systems

SECTION 09—STEERING SYSTEM

- Group 0960—Hydraulic System Steering Valve and Cylinder

SECTION 10—SERVICE BRAKES

- Group 1011—Active Elements, Brake Disks and Control Linkage
- Group 1060—Hydraulic System Brake Valve

Continued on next page

All information, illustrations and specifications contained in this technical manual are based on the latest information available at the time of publication. The right is reserved to make changes at any time without notice.

COPYRIGHT® 1988
DEERE & COMPANY
Moline, Illinois
All rights reserved
A John Deere ILLUSTRATION™ Manual

T64;1469 K1 070289

SECTION 11—PARK BRAKES

- Group 1111—Active Elements
- Group 1115—Controls Linkage

SECTION 16—ELECTRICAL SYSTEMS

- Group 1671—Batteries, Support and Cables
- Group 1672—Alternator, Regulator and Charging System Wiring
- Group 1673—Lighting System
- Group 1674—Wiring Harness and Switches
- Group 1675—System Controls
- Group 1676—Instruments, Indicators and Senders
- Group 1677—Motors and Actuators

SECTION 17—FRAME, CHASSIS, OR SUPPORTING STRUCTURE

- Group 1740—Frame Installation
- Group 1749—Chassis Weights

SECTION 18—OPERATOR'S STATION

- Group 1800—Removal and Installation
- Group 1810—Operator Enclosure
Wiper Motor and Windshield Washer
- Group 1821—Seat and Seat Belt
- Group 1830—Heating and Air Conditioning

SECTION 20—SAFETY, CONVENIENCE AND MISCELLANEOUS

- Group 2004—Horn and Warning Devices

SECTION 21—MAIN HYDRAULIC SYSTEM

- Group 2160—Hydraulic System
Main Hydraulic Pump, Pump Drive,
Main Hydraulic Filter, Oil Cooler, Oil
Cooler Bypass Valve, and System
Relief Valve

SECTION 31—LOADER

- Group 3100—Removal and Installation
- Group 3102—Buckets
- Group 3115—Controls Linkage
- Group 3140—Frames
- Group 3160—Hydraulic System
Control Valve and Cylinders

SECTION 33—BACKHOE

- Group 3302—Buckets
- Group 3315—Controls Linkage
- Group 3340—Frames
- Group 3360—Hydraulic System
Control Valve and Cylinders

T64;1469 K2 060289

Group I Safety Information

HANDLE FLUIDS SAFELY—AVOID FIRES

When you work around fuel, do not smoke or work near heaters or other fire hazards.

Store flammable fluids away from fire hazards. Do not incinerate or puncture pressurized containers.

Make sure machine is clean of trash, grease, and debris.

Do not store oily rags; they can ignite and burn spontaneously.



AB6;TS227 053;FLAME 050188

PREVENT BATTERY EXPLOSIONS

Keep sparks, lighted matches, and open flame away from the top of battery. Battery gas can explode.

Never check battery charge by placing a metal object across the posts. Use a volt-meter or hydrometer.

Do not charge a frozen battery; it may explode. Warm battery to 16°C (60°F).



AB6;TS204 053;SPARKS 280688

PREPARE FOR EMERGENCIES

Be prepared if a fire starts.

Keep a first aid kit and fire extinguisher handy.

Keep emergency numbers for doctors, ambulance service, hospital, and fire department near your telephone.

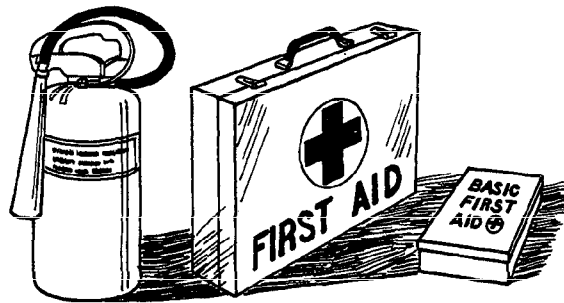

AB6;TS186 053;FIRE2 080785

Safety Information

PREVENT ACID BURNS

Sulfuric acid in battery electrolyte is poisonous. It is strong enough to burn skin, eat holes in clothing, and cause blindness if splashed into eyes.

Avoid the hazard by:

1. Filling batteries in a well-ventilated area.
2. Wearing eye protection and rubber gloves.
3. Avoiding breathing fumes when electrolyte is added.
4. Avoiding spilling or dripping electrolyte.
5. Use proper jump start procedure.

If you spill acid on yourself:

1. Flush your skin with water.
2. Apply baking soda or lime to help neutralize the acid.
3. Flush your eyes with water for 10-15 minutes. Get medical attention immediately.

If acid is swallowed:

1. Drink large amounts of water or milk.
2. Then drink milk of magnesia, beaten eggs, or vegetable oil.
3. Get medical attention immediately.

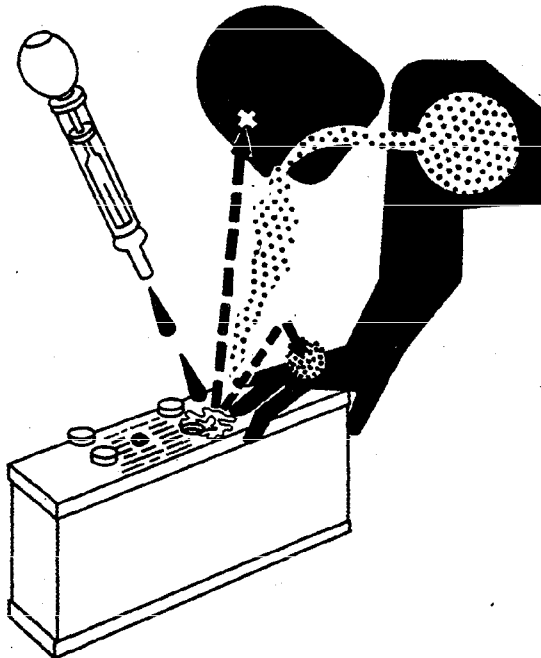

AB6;TS203 053;POISON 211287

AVOID HIGH-PRESSURE FLUIDS

Escaping fluid under pressure can penetrate the skin causing serious injury. Relieve pressure before unhooking hydraulic or other lines. Tighten all connections before applying pressure. Keep hands and body away from pinholes and nozzles which eject fluids under high pressure. Use a piece of cardboard to search for leaks.

If ANY fluid is injected into the skin, it must be surgically removed within a few hours by a doctor familiar with this type injury or gangrene may result.

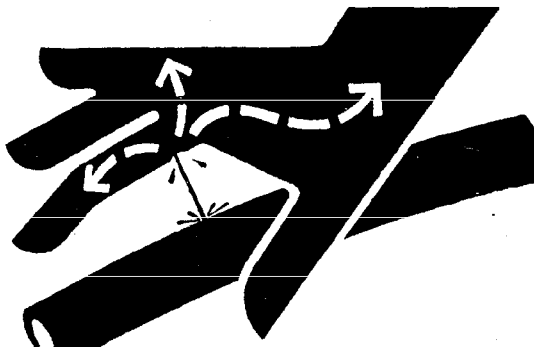

AB6;X9811 053;FLUID 180987

PARK MACHINE SAFELY

Before working on the machine:

- Lower all equipment to the ground.
- Stop the engine and remove the key.
- Disconnect the battery ground strap.
- Hang a "DO NOT OPERATE" tag in operator station.

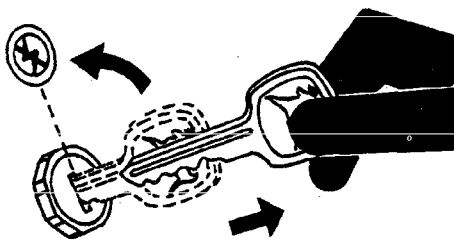

AB6;TS230 053;PARK 050188

Safety Information

SUPPORT MACHINE PROPERLY

Always lower the attachment or implement to the ground before you work on the machine. If you must work on a lifted machine or attachment, securely support the machine or attachment.

Do not support the machine on cinder blocks, hollow tiles, or props that may crumble under continuous load. Do not work under a machine that is supported solely by a jack. Follow recommended procedures in this manual.

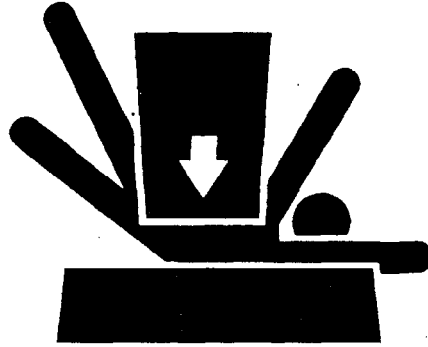

AB6;TS229 053;LOWER 211287

WEAR PROTECTIVE CLOTHING

Wear close fitting clothing and safety equipment appropriate to the job.

Prolonged exposure to loud noise can cause impairment or loss of hearing.

Wear a suitable hearing protective device such as earmuffs or earplugs to protect against objectionable or uncomfortable loud noises.

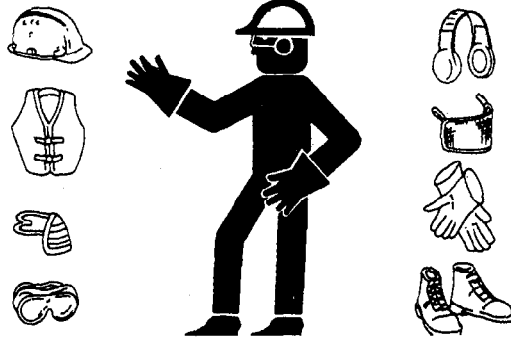

AB6;TS206 053;WEAR 230487

SERVICE MACHINE SAFELY

Tie long hair behind your head. Do not wear a necktie, scarf, loose clothing, or necklace when you work near machine tools or moving parts. If these items were to get caught, severe injury could result.

Remove rings and other jewelry to prevent electrical shorts and entanglement in moving parts.

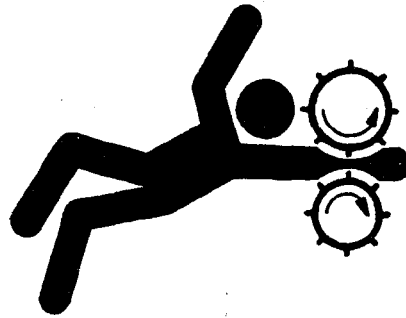

AB6;TS228 053;LOOSE 211287

WORK IN VENTILATED AREA

Engine exhaust fumes can cause sickness or death. If it is necessary to run an engine in an enclosed area, remove the exhaust fumes from the area with an exhaust pipe extension.

If you do not have an exhaust pipe extension, open the doors and get outside air into the area.

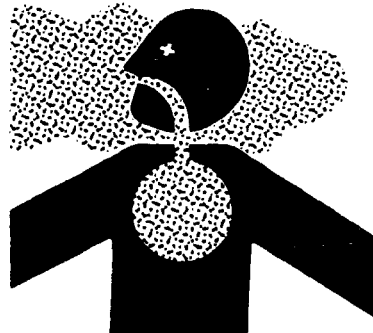

AB6;TS220 053;AIR 050189

Safety Information

UNDERSTAND CORRECT SERVICE

Illuminate your work area adequately but safely. Use a portable safety light for working inside or under the machine. Make sure the bulb is enclosed by a wire cage. The hot filament of an accidentally broken bulb can ignite spilled fuel or oil.

Catch draining fuel, oil, or other fluids in suitable containers. Do not use food or beverage containers that may mislead someone into drinking from them. Wipe up spills at once.

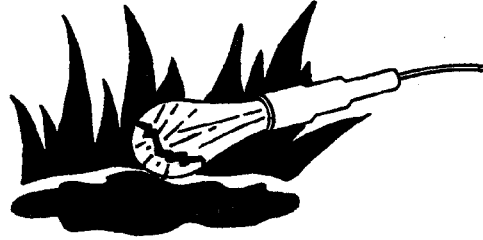

AB6;TS223 053;LIGHT 230288

REPLACE SAFETY SIGNS

Replace missing or damaged safety signs. See the machine operator's manual for correct safety sign placement.

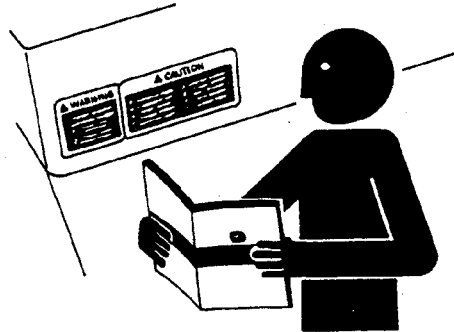

AB6;TS201 053;SIGNS1 221287

USE PROPER LIFTING EQUIPMENT

Lifting heavy components incorrectly can cause severe injury or machine damage.

Follow recommended procedure for removal and installation of components in the manual.

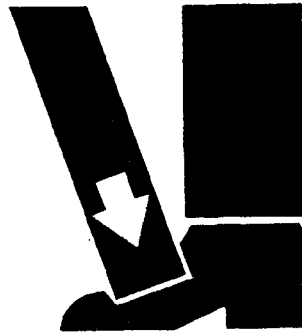

AB6;TS226 053;LIFT 050188

KEEP ROPS INSTALLED PROPERLY

Make certain all parts are reinstalled correctly if the roll-over protective structure (ROPS) is loosened or removed for any reason. Tighten mounting bolts to proper torque.

The protection offered by ROPS will be impaired if ROPS is subjected to structural damage, is involved in an overturn incident, or is in any way altered by welding, bending, drilling, or cutting. A damaged ROPS should be replaced, not reused.

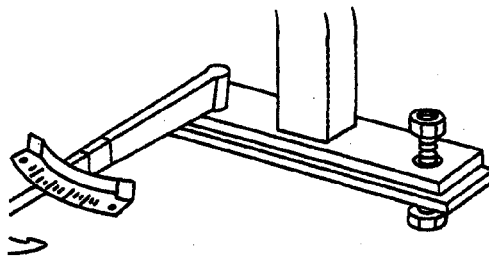

AB6;TS212 053;ROPS3 230487

SERVICE TIRES SAFELY

Explosive separation of a tire and rim parts can cause serious injury or death.

Do not attempt to mount a tire unless you have the proper equipment and experience to perform the job.

Always maintain the correct tire pressure. Do not inflate the tires above the recommended pressure.

When inflating tires, use a clip-on chuck and extension hose long enough to allow you to stand to one side and NOT in front of or over the tire assembly. Use a safety cage if available.

Check wheels for low pressure, cuts, bubbles, damaged rims or missing lug bolts and nuts.

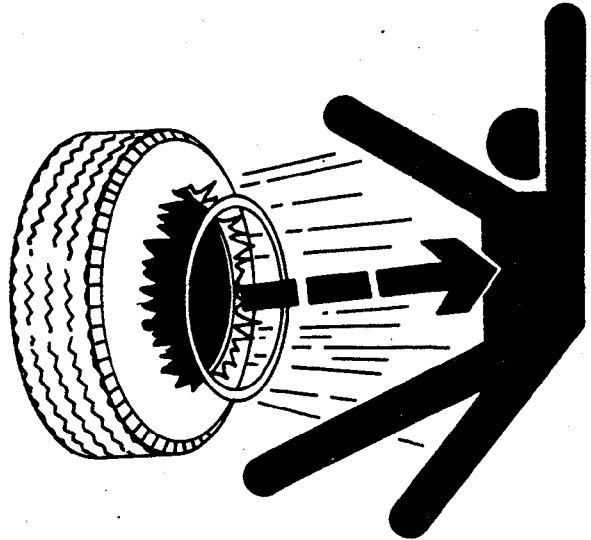

AB6;TS211 053;RIM 211287

AVOID HARMFUL ASBESTOS DUST

Avoid breathing dust that may be generated when handling components containing asbestos fibers. Inhaled asbestos fibers may cause lung cancer.

Components in John Deere products that may contain asbestos fibers are brake pads, brake band and lining assemblies, clutch plates, and some gaskets. The asbestos used in these components is usually found in a resin or sealed in some way. Normal handling is not hazardous as long as airborne dust containing asbestos is not generated.

Avoid creating dust. Never use compressed air for cleaning. Avoid brushing or grinding of asbestos containing materials. When servicing, wear an approved respirator. A special vacuum cleaner is recommended to clean asbestos. If not available, wet the asbestos containing materials with a mist of oil or water.

Keep bystanders away from the area.

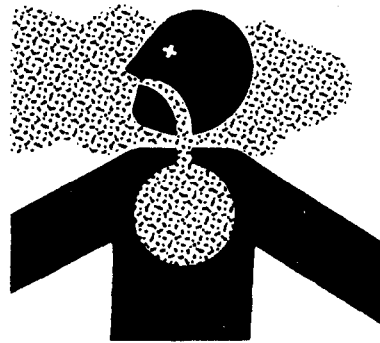

AB6;TS220 053;DUST 140488

PRACTICE SAFE MAINTENANCE

Understand service procedure before doing work. Keep area clean and dry.

Never lubricate or service machine while it is moving. Keep hands, feet, and clothing from power-driven parts. Disengage all power and operate controls to relieve pressure. Lower equipment to the ground. Stop the engine. Remove the key. Allow machine to cool.

Securely support any machine elements that must be raised for service work.

Keep all parts in good condition and properly installed. Fix damage immediately. Replace worn or broken parts. Remove any buildup of grease, oil, or debris.

Disconnect battery ground cable (-) before making adjustments on electrical systems or welding on machine.



AB6;TS218 053;SERV 211287

STORE ATTACHMENTS SAFELY

Stored attachments such as dual wheels, cage wheels, and loaders can fall and cause serious injury or death.

Securely store attachments and implements to prevent falling. Keep playing children and bystanders away from storage area.



AB6;TS219 053;STORE 120487

WORK IN CLEAN AREA

Before starting a job:

- Clean work area and machine.
- Make sure you have all necessary tools to do your job.
- Have the right parts on hand.
- Read all instructions thoroughly; do not attempt shortcuts.

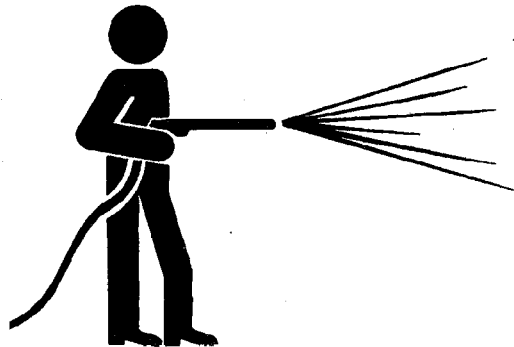

AB6;T6642E J 053;CLEAN 190188

Safety Information

USE TOOLS PROPERLY

Use tools appropriate to the work. Makeshift tools, parts, and procedures will not make good repairs.

Use pneumatic and electric tools only to loosen threaded parts and fasteners. Never use such tools to tighten fasteners, especially on light alloy parts.

Use only replacement parts meeting John Deere specifications.

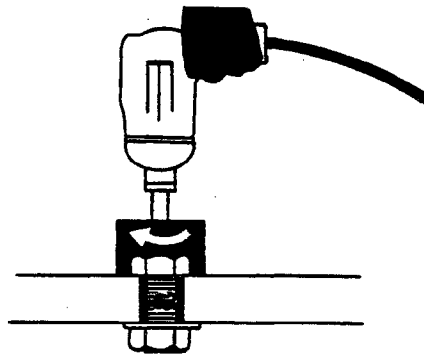

AB6;TS221 053;REPAIR 211287

DISPOSE FLUIDS PROPERLY

Be mindful of the environment and ecology. Before you drain fluids, find out the proper way to dispose of the oil.

Do not pour oil onto the ground, down a drain, or into a stream, pond, or lake. Consult local ordinances that govern the disposal of wastes.

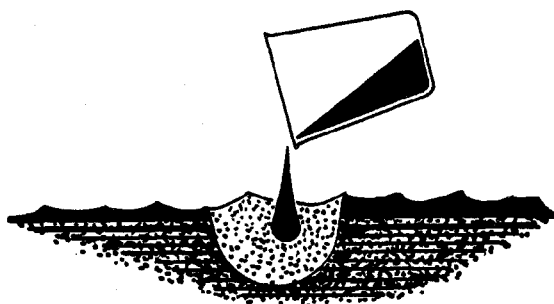

AB6;TS222 053;DRAIN 211287

LIVE WITH SAFETY

Before returning machine to customer, make sure machine is functioning properly, especially the safety systems. Install all guards and shields.



AB6;TS231 053;LIVE 050188

Safety Information

General Specifications

410C BACKHOE LOADER

Wheel Treads:

Front (without MFWD)	69 in. (1757 mm)
(with MFWD)	68 in. (1727 mm)
Rear (without MFWD)	64 in. (1625 mm)
(with MFWD)	69 in. (1757 mm)

Wheelbase:

(Without MFWD)	82.7 in. (2100 mm)
(With MFWD)	83.3 in. (2116 mm)

Axle Ratings: (SAE J43)

Front	11 700 lb (5300 kg)
Rear	15 400 lb (7000 kg)

Buckets:

Loader:	Width		Struck Capacity		Heaped Capacity	
	In.	(mm)	Cu. Yd.	(m ³)	Cu. Yd.	(m ³)
(Long Lip)	89.4	(2270)	1.05	(0.80)	1.25	(0.96)
	92	(2337)	0.88	(0.67)	1.0	(0.76)
	92	(2337)	1.07	(0.82)	1.3	(1.00)

Backhoe:	In.	(mm)	Cu. Ft.	(m ³)	Cu. Ft.	(m ³)
Standard	12	(305)	2.6	(0.07)	3.0	(0.08)
	16	(406)	3.7	(0.10)	4.5	(0.13)
	18	(457)	4.2	(0.12)	5.1	(0.14)
	24	(610)	5.9	(0.17)	7.5	(0.21)
	30	(762)	7.5	(0.21)	10.0	(0.28)
Heavy duty	36	(914)	7.5	(0.21)	10.0	(0.28)
	18	(457)	4.2	(0.12)	5.1	(0.14)
	24	(610)	5.9	(0.17)	7.5	(0.21)
High Capacity	30	(762)	7.5	(0.21)	10.0	(0.28)
	24	(610)	7.2	(0.20)	8.8	(0.25)
Capacity	36	(914)	11.2	(0.32)	14.5	(0.41)

Transporting:

SAE operating weight with ROPS	6550 kg (14,400 lb)
--------------------------------------	------------------------

General Specifications

410C BACKHOE LOADER

Drain and Refill Capacities:

	U.S.	Metric
Engine coolant (no heater)	14 qt	13 L
Engine coolant (with heater)	16 qt	15 L
Engine oil (including filter)	9 qt	8.5 L
Torque converter and reverser (including filter)	12 qt	11 L
Transaxle-hydraulic system (without MFWD)	10 gal	38 L
(with MFWD)	11.5 gal	44 L
Fuel tank	23 gal	87 L
Auxiliary fuel tank (if equipped)	15 gal	57 L
Front axle (MFWD)	7 qt	6.5 L
Front wheel planetary (MFWD)	1.1 qt	1.0 L

05T;115 K8 060289

General Specifications

410C BACKHOE LOADER

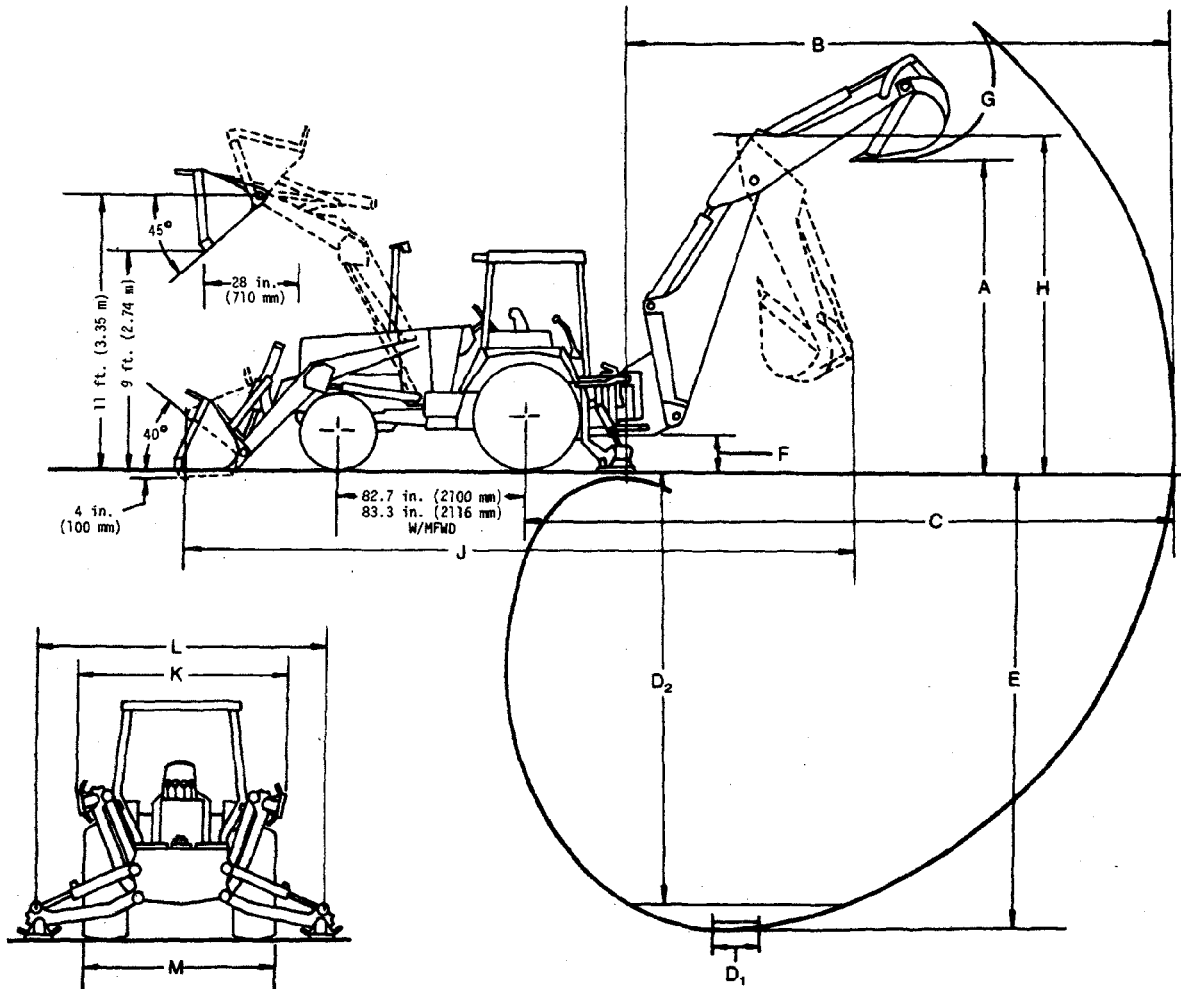

002;T6245AE T82;115 C8 060289

General Specifications

410C BACKHOE LOADER

Key:	Backhoe* with Long	Extendible Dipperstick	
	Dipperstick	Retracted	Extended
A. Loading height, truck loading position	11 ft. 10 in. (3.62 m)	11 ft. 6 in. (3.51 m)	13 ft. 11 in. (4.24 m)
B. Reach from center of swing mast	18 ft. 5 in. (5.62 m)	17 ft. 9 in. (5.42 m)	21 ft. 5 in. (6.52 m)
C. Reach from center of rear axle	22 ft. 2 in. (6.76 m)	21 ft. 6 in. (6.56 m)	25 ft. 2 in. (7.66 m)
D. Digging depth (SAE):			
(1) 2 ft. (610 mm) flat bottom	15 ft. 3 in. (4.64 m)	14 ft. 6 in. (4.42 m)	18 ft. 4 in. (5.59 m)
(2) 8 ft. (2440 mm) flat bottom	14 ft. 2 in. (4.32 m)	13 ft. 5 in. (4.09 m)	17 ft. 6 in. (5.34 m)
E. Maximum digging depth	15 ft. 4 in. (4.68 m)	14 ft. 8 in. (4.46 m)	18 ft. 5 in. (5.62 m)
F. Ground clearance, minimum	12 in. (305 mm)	12 in. (305 mm)	12 in. (305 mm)
G. Bucket rotation	160° and 180°	160° and 180°	160° and 180°
H. Transport height	11 ft. 5 in. (3.49 m)	11 ft. 8 in. (3.57 m)	11 ft. 8 in. (3.57 m)
J. Overall length, transport	23 ft. 5 in. (7.14 m)	23 ft. (7.01 m)	23 ft. (7.01 m)
K. Stabilizer width—transport	7 ft. 8 in. (2.34 m)	7 ft. 8 in. (2.34 m)	7 ft. 8 in. (2.34 m)
L. Stabilizer spread—operating	9 ft. 10 in. (3.0 m)	9 ft. 10 in. (3.0 m)	9 ft. 10 in. (3.0 m)
M. Overall width (less loader bucket)	82 in. (2070 mm)	82 in. (2070 mm)	82 in. (2070 mm)
Digging force, bucket cylinder (power dig position)	11700 lb (5310 kg)	11700 lb (5310 kg)	11700 lb (5310 kg)
Digging force, crowd cylinder	6300 lb (2860 kg)	6800 lb (3080 kg)	4600 lb (2090 kg)
Swing arc	180°	180°	180°
Operator control	Two levers	Right foot treadle	Right foot treadle
Bucket positions	9° and 18° rollback	8° and 17° rollback	12° and 22° rollback
Stabilizer angle rearward	14.5°	14.5°	14.5°
Lifting capacity, maximum boom @ 65°	4100 lb (1860 kg)	4100 lb (1860 kg)	2700 lb (1220 kg)

NOTE: Backhoe specifications are with 24 in. (610 mm) 7.5 cu ft (0.21 m³) standard bucket.

T82;115 C9 060289