

**John Deere
610B and 610C
Backhoe Loaders
Operation and Test**

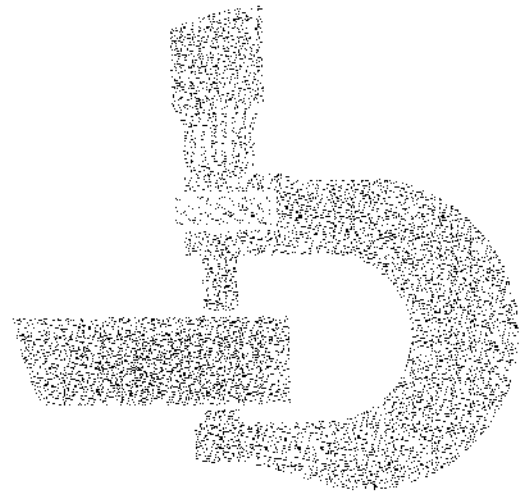

TECHNICAL MANUAL

TM-1446 (Mar-89)

LITHO IN U.S.A.

Introduction

FOREWORD

This manual is written for an experienced technician. Essential tools required in performing certain service work are identified in this manual and are recommended for use.

Live with safety: Read the safety messages in the introduction of this manual and the cautions presented throughout the text of the manual.



This is the safety-alert symbol. When you see this symbol on the machine or in this manual, be alert to the potential for personal injury.

Technical manuals are divided in two parts: repair and diagnostics. Repair sections tell how to repair the components. Diagnostic sections help you identify the majority of routine failures quickly.

Information is organized in groups for the various components requiring service instruction. At the beginning of each group are summary listings of all applicable essential tools, service equipment and tools, other materials needed to do the job, service parts kits, specifications, wear tolerances, and torque values.

Binders, binder labels, and tab sets can be ordered by John Deere dealers direct from the John Deere Distribution Service Center.

This manual is part of a total product support program.

FOS Manuals-reference

Technical Manuals-machine service

Component Manuals-component service

Fundamentals of Service (FOS) Manuals cover basic theory of operation, fundamentals of troubleshooting, general maintenance, and basic types of failures and their causes. FOS Manuals are for training new personnel and for reference by experienced technicians.

Technical Manuals are concise guides for specific machines. Technical manuals are on-the-job guides containing only the vital information needed for diagnosis, analysis, testing, and repair.

Component Technical Manuals are concise service guides for specific components. Component technical manuals are written as stand-alone manuals covering multiple machine applications.

JOHN DEERE DEALERS

IMPORTANT: Please remove this page and route through your service department.

This is a complete revision for TM-1446 (Test), 610B and 610C. Backhoe Loaders.

The new pages are dated (Mar-89). Listed below is a brief explanation of "WHAT" was changed and "WHY" it was changed.

This manual was revised:

1. Correct Front Wheel toe-in specifications.
2. Miscellaneous revisions and updates.

T64;1446 DCS 010389

**Thanks very much for your reading,
Want to get more information,
Please click here, Then get the complete
manual**

JustClickHere 

NOTE:

**If there is no response to click on the link above,
please download the PDF document first, and then
click on it.**

**Have any questions please write to me:
admin@servicemanualperfect.com**

610B AND 610C BACKHOE LOADER TECHNICAL MANUAL TM-1446 (Mar-89)

SECTION AND GROUP CONTENTS

NOTE: This manual covers machine Operation and Test . For Repair information, see TM-1447.

SECTION I—General Information

- Group I—Introduction and Safety Information
- Group II—General Specifications
- Group III—Torque Values
- Group IV—Fuels and Lubrication

SECTION 9005—Operational Checkout Procedure

SECTION 9010—Engine

- Group 05—Theory of Operation
- Group 10—System Operational Checks
- Group 15—Diagnostic Information
- Group 20—Adjustments
- Group 25—Tests

SECTION 9015—Electrical System (610B)

SECTION 9015—Electrical System (610C)

- Group 05—Theory of Operation
- Group 10—System Operational Checks
- Group 15—Diagnostic Information
- Group 25—Tests

SECTION 9020—Power Train

- Group 05—Theory of Operation
- Group 10—System Operational Checks
- Group 15—Diagnostic Information
- Group 20—Adjustments
- Group 25—Tests

SECTION 25—Hydraulic System

- Group 05—Theory of Operation
- Group 10—System Operational Checks
- Group 15—Diagnostic Information
- Group 20—Adjustments
- Group 25—Tests

SECTION 99—Dealer Fabricated Tools

All information, illustrations and specifications contained in this technical manual are based on the latest information available at the time of publication. The right is reserved to make changes at any time without notice.

COPYRIGHT® 1989
DEERE & COMPANY
Moline, Illinois
All rights reserved
A John Deere ILLUSTRATION™ Manual
Previous Editions
Copyright® 1986, 1988 Deere & Company

T64;1446 J1 030289

FOREWORD

This manual is written for an experienced technician. Essential tools required in performing certain service work are identified in this manual and are recommended for use.

Live with safety: Read the safety messages in the introduction of this manual and the cautions presented throughout the text of the manual.



This is the safety-alert symbol. When you see this symbol on the machine or in this manual, be alert to the potential for personal injury.

Technical manuals are divided in two parts: repair and diagnostics. Repair sections tell how to repair the components. Diagnostic sections help you identify the majority of routine failures quickly.

Information is organized in groups for the various components requiring service instruction. At the beginning of each group are summary listings of all applicable essential tools, service equipment and tools, other materials needed to do the job, service parts kits, specifications, wear tolerances, and torque values.

Binders, binder labels, and tab sets can be ordered by John Deere dealers direct from the John Deere Distribution Service Center.

This manual is part of a total product support program.

FOS Manuals-reference

Technical Manuals-machine service

Component Manuals-component service

Fundamentals of Service (FOS) Manuals cover basic theory of operation, fundamentals of troubleshooting, general maintenance, and basic types of failures and their causes. FOS Manuals are for training new personnel and for reference by experienced technicians.

Technical Manuals are concise guides for specific machines. Technical manuals are on-the-job guides containing only the vital information needed for diagnosis, analysis, testing, and repair.

Component Technical Manuals are concise service guides for specific components. Component technicals manuals are written as stand-alone manuals covering multiple machine applications.

HANDLE FLUIDS SAFELY—AVOID FIRES

When you work around fuel, do not smoke or work near heaters or other fire hazards.

Store flammable fluids away from fire hazards. Do not incinerate or puncture pressurized containers.

Make sure machine is clean of trash, grease, and debris.

Do not store oily rags; they can ignite and burn spontaneously.



AB6;TS227 053;FLAME 050188

PREVENT BATTERY EXPLOSIONS

Keep sparks, lighted matches, and open flame away from the top of battery. Battery gas can explode.

Never check battery charge by placing a metal object across the posts. Use a volt-meter or hydrometer.

Do not charge a frozen battery; it may explode. Warm battery to 16°C (60°F).

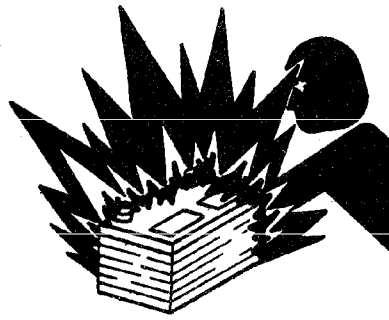

ABT;TS204 053;SPARKS 050188

PREPARE FOR EMERGENCIES

Be prepared if a fire starts.

Keep a first aid kit and fire extinguisher handy.

Keep emergency numbers for doctors, ambulance service, hospital, and fire department near your telephone.

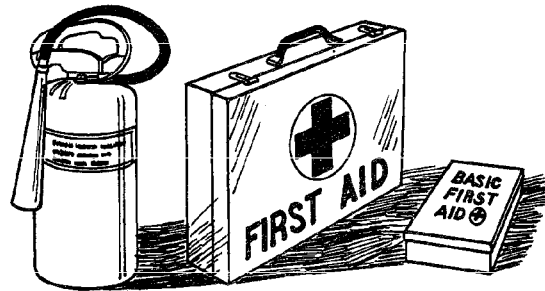

AB6;TS186 053;FIRE2 080785

PREVENT ACID BURNS

Sulfuric acid in battery electrolyte is poisonous. It is strong enough to burn skin, eat holes in clothing, and cause blindness if splashed into eyes.

Avoid the hazard by:

1. Filling batteries in a well-ventilated area.
2. Wearing eye protection and rubber gloves.
3. Avoiding breathing fumes when electrolyte is added.
4. Avoiding spilling or dripping electrolyte.
5. Use proper jump start procedure.

If you spill acid on yourself:

1. Flush your skin with water.
2. Apply baking soda or lime to help neutralize the acid.
3. Flush your eyes with water for 10-15 minutes. Get medical attention immediately.

If acid is swallowed:

1. Drink large amounts of water or milk.
2. Then drink milk of magnesia, beaten eggs, or vegetable oil.
3. Get medical attention immediately.

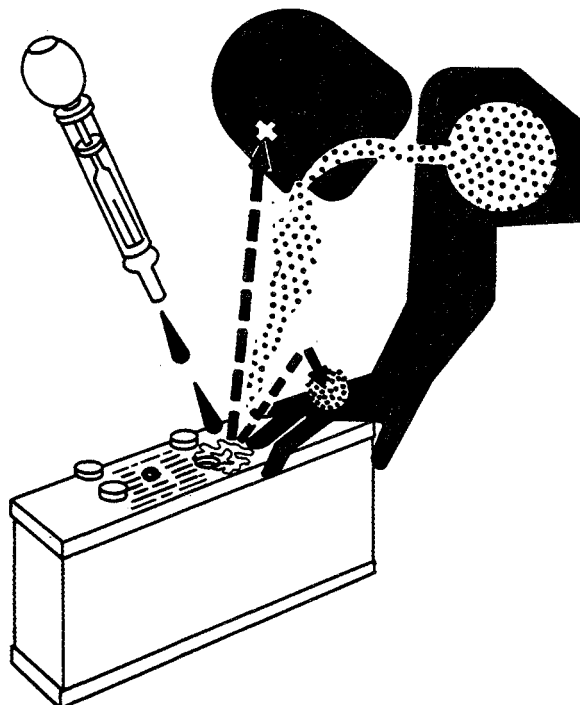

AB6;TS203 053;POISON 211287

AVOID HIGH-PRESSURE FLUIDS

Escaping fluid under pressure can penetrate the skin causing serious injury. Relieve pressure before unhooking hydraulic or other lines. Tighten all connections before applying pressure. Keep hands and body away from pinholes and nozzles which eject fluids under high pressure. Use a piece of cardboard to search for leaks.

If ANY fluid is injected into the skin, it must be surgically removed within a few hours by a doctor familiar with this type injury or gangrene may result.



AB6;X9811 053;FLUID 180987

PARK MACHINE SAFELY

Before working on the machine:

- Lower all equipment to the ground.
- Stop the engine and remove the key.
- Disconnect the battery ground strap.
- Hang a "DO NOT OPERATE" tag in operator station.

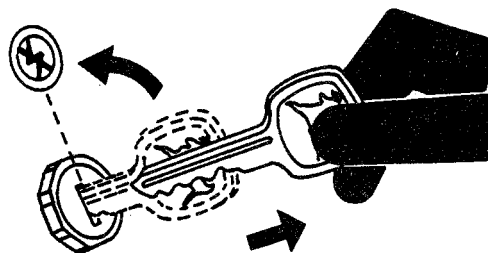

AB6;TS230 053;PARK 050188

SUPPORT MACHINE PROPERLY

Always lower the attachment or implement to the ground before you work on the machine. If you must work on a lifted machine or attachment, securely support the machine or attachment.

Do not support the machine on cinder blocks, hollow tiles, or props that may crumble under continuous load. Do not work under a machine that is supported solely by a jack. Follow recommended procedures in this manual.

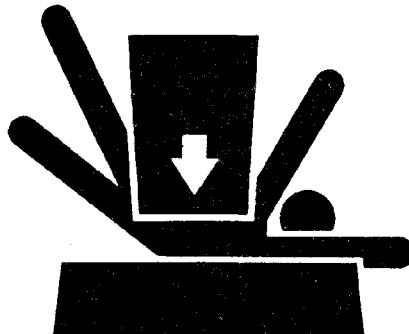

AB6;TS229 053;LOWER 211287

WEAR PROTECTIVE CLOTHING

Wear close fitting clothing and safety equipment appropriate to the job.

Prolonged exposure to loud noise can cause impairment or loss of hearing.

Wear a suitable hearing protective device such as earmuffs or earplugs to protect against objectionable or uncomfortable loud noises.

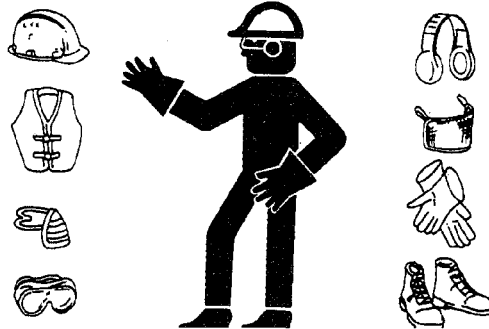

AB6;TS206 053;WEAR 230487

SERVICE MACHINE SAFELY

Tie long hair behind your head. Do not wear a necktie, scarf, loose clothing, or necklace when you work near machine tools or moving parts. If these items were to get caught, severe injury could result.

Remove rings and other jewelry to prevent electrical shorts and entanglement in moving parts.

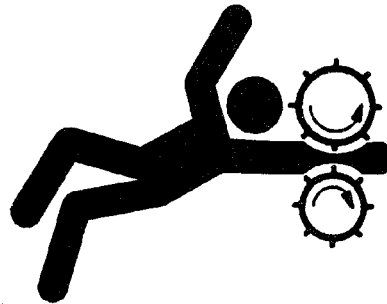

AB6;TS228 053;LOOSE 211287

WORK IN VENTILATED AREA

Engine exhaust fumes can cause sickness or death. If it is necessary to run an engine in an enclosed area, remove the exhaust fumes from the area with an exhaust pipe extension.

If you do not have an exhaust pipe extension, open the doors and get outside air into the area.



AB6;TS220 053;AIR 050188

UNDERSTAND CORRECT SERVICE

Illuminate your work area adequately but safely. Use a portable safety light for working inside or under the machine. Make sure the bulb is enclosed by a wire cage. The hot filament of an accidentally broken bulb can ignite spilled fuel or oil.

Catch draining fuel, oil, or other fluids in suitable containers. Do not use food or beverage containers that may mislead someone into drinking from them. Wipe up spills at once.

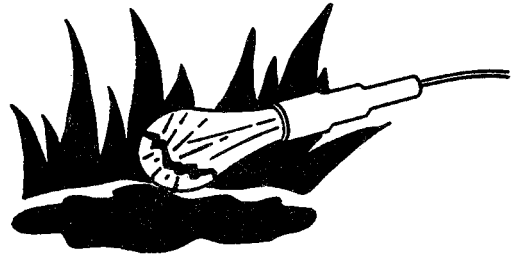

AB6;TS223 053;LIGHT 230288

REPLACE SAFETY SIGNS

Replace missing or damaged safety signs. See the machine operator's manual for correct safety sign placement.

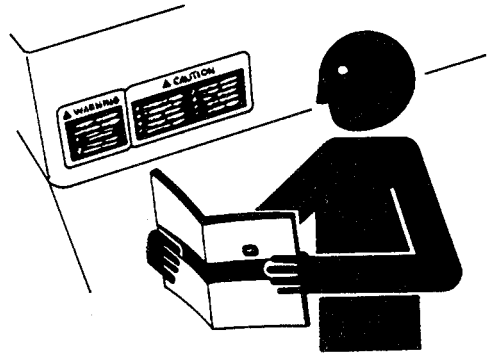

AB6;TS201 053;SIGNS1 221287

USE PROPER LIFTING EQUIPMENT

Lifting heavy components incorrectly can cause severe injury or machine damage.

Follow recommended procedure for removal and installation of components in the manual.

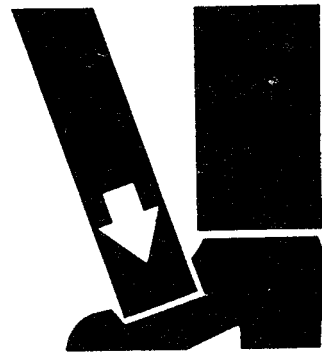

AB6;TS226 053;LIFT 050188

KEEP ROPS INSTALLED PROPERLY

Make certain all parts are reinstalled correctly if the roll-over protective structure (ROPS) is loosened or removed for any reason. Tighten mounting bolts to proper torque.

The protection offered by ROPS will be impaired if ROPS is subjected to structural damage, is involved in an overturn incident, or is in any way altered by welding, bending, drilling, or cutting. A damaged ROPS should be replaced, not reused.

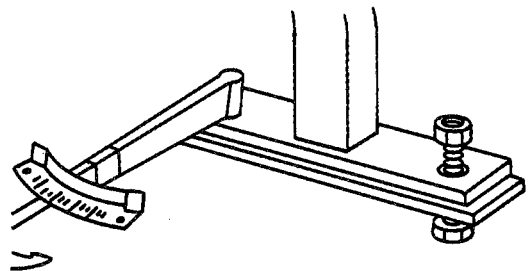

AB6;TS212 053;ROPS3 230487

SERVICE TIRES SAFELY

Explosive separation of a tire and rim parts can cause serious injury or death.

Do not attempt to mount a tire unless you have the proper equipment and experience to perform the job.

Always maintain the correct tire pressure. Do not inflate the tires above the recommended pressure.

When inflating tires, use a clip-on chuck and extension hose long enough to allow you to stand to one side and NOT in front of or over the tire assembly. Use a safety cage if available.

Check wheels for low pressure, cuts, bubbles, damaged rims or missing lug bolts and nuts.

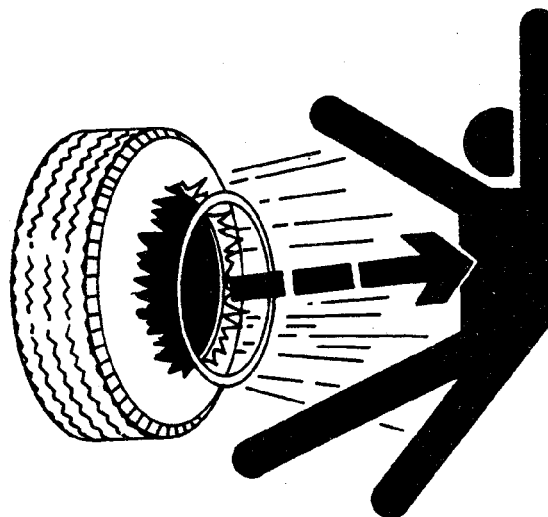

AB6;TS211 053;RIM 211287

AVOID HARMFUL ASBESTOS DUST

Avoid breathing dust that may be generated when handling components containing asbestos fibers. Inhaled asbestos fibers may cause lung cancer.

Components in John Deere products that may contain asbestos fibers are brake pads, brake band and lining assemblies, clutch plates, and some gaskets. The asbestos used in these components is usually found in a resin or sealed in some way. Normal handling is not hazardous as long as airborne dust containing asbestos is not generated.

Avoid creating dust. Never use compressed air for cleaning. Avoid brushing or grinding of asbestos containing materials. When servicing, wear an approved respirator. A special vacuum cleaner is recommended to clean asbestos. If not available, wet the asbestos containing materials with a mist of oil or water.

Keep bystanders away from the area.

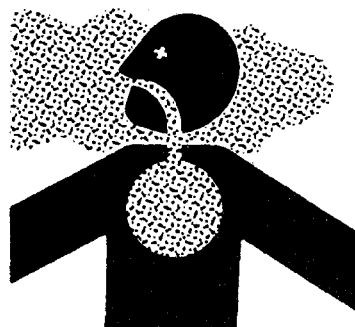

AB6;TS220 053;DUST 050188

WORK IN CLEAN AREA

Before starting a job:

- Clean work area and machine.
- Make sure you have all necessary tools to do your job.
- Have the right parts on hand.
- Read all instructions thoroughly; do not attempt shortcuts.

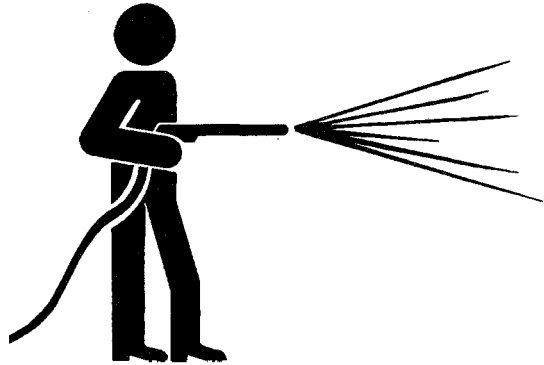

AB6;T6642E J 053;CLEAN 190188

USE TOOLS PROPERLY

Use tools appropriate to the work. Makeshift tools, parts, and procedures will not make good repairs.

Use pneumatic and electric tools only to loosen threaded parts and fasteners. Never use such tools to tighten fasteners, especially on light alloy parts.

Use only replacement parts meeting John Deere specifications.

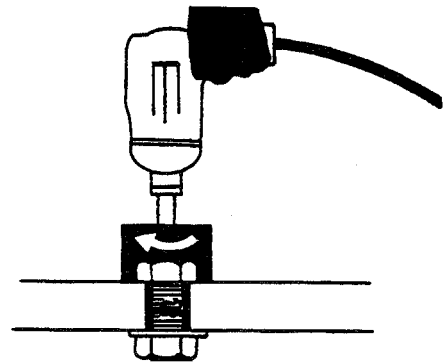

AB6;TS221 053;REPAIR 211287

DISPOSE FLUIDS PROPERLY

Be mindful of the environment and ecology. Before you drain fluids, find out the proper way to dispose of the oil.

Do not pour oil onto the ground, down a drain, or into a stream, pond, or lake. Consult local ordinances that govern the disposal of wastes.

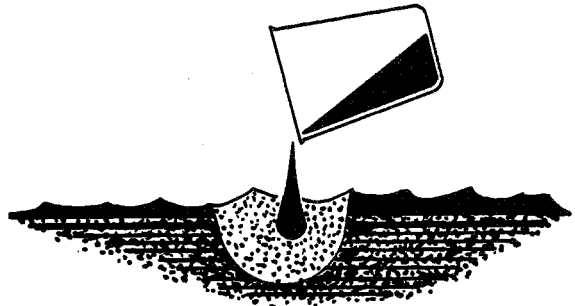

AB6;TS222 053;DRAIN 211287

LIVE WITH SAFETY

Before returning machine to customer, make sure machine is functioning properly, especially the safety systems. Install all guards and shields.



AB6;TS231 053;LIVE 050188

Introduction and Safety

610B BACKHOE LOADER

(Specifications and design subject to change without notice. Wherever applicable, specifications are in accordance with ICED and SAE Standards. Except where otherwise noted, these specifications are based on a standard machine with 19.5L-24, 12 PR, R4 rear tires; 11L-16, 12PR, F3 front tires; 1.3 cu.-yd. (1.0 m³) loader bucket; 24-in. (610 mm) high capacity backhoe bucket; ROPS/FOPS; full fuel tank and 175-lb. (79 kg) operator).

Power

(@ 2200 engine rpm):	SAE	DIN
Gross	86 hp (64 kW)	
Net	80 hp (60 kW)	81 hp (60 kW)

Net engine flywheel power is for an engine equipped with fan, air cleaner, water pump, lubricating oil pump, fuel pump, alternator, and muffler. Gross engine power is without fan. Flywheel power ratings are under SAE standard conditions of 500-ft. (150 m) altitude and 85°F (29.5°C) temperature and DIN 70 020 standard conditions of 760 mm Hg barometer (sea level) and 20°C temperature.

Engine: John Deere 4-cylinder diesel, valve in head 4-stroke cycle

Bore and stroke	4.19 x 5.00 in. (106 x 127 mm)
Displacement	276 cu. in. (4.524 L)
Compression ratio	16.2 to 1
Maximum torque @ 1300 rpm	248 lb-ft (336 N·m)
NACC or AMA (U.,S. Tax) horsepower	28
Main bearings	5
Lubrication	Pressure system w/full-flow filter and cooler
Cooling	Pressurized w/thermostat and fixed bypass
Fan	Suction
Air Cleaner	Dry
Electrical system	12-volt
Alternator	51 amps w/cab, 35 amps regular

Transmission:

Full power shift, 8 speeds forward, 4 reverse. Modulated, full power shift between forward and reverse in first thru fourth speeds. Reverser operating lever left of steering wheel. Single speed-change lever in right console.

Travel Speeds:	Gear	Forward		Reverse	
		mph	km/h	mph	km/h
	1	1.8	2.9	2.2	3.5
	2	2.5	4.0	3.1	5.0
	3	3.9	6.3	4.8	7.7
	4	5.1	8.2	6.2	10.0
	5	6.6	10.6		
	6	8.5	13.7		
	7	11.2	18.0		
	8	18.8	30.3		

Final Drives Planetary, inboard

Service Brakes:

Manual hydraulic, applied with separate pedals; hydraulically equalized when both pedals are depressed. Wet disks and facings are fully enclosed and self-adjusting.

Steering: Hydrostatic Power

Turning radius (brake applied)	10 ft. 3 in. (3.12 m)
Clearance circle	29 ft. 6 in. (9 m)
Steering wheel turns, left to right	2.9
right to left	3.9

Hydraulic System: Closed center (variable flow, constant pressure)

Pressure	2500 psi (17 238 kPa)
Pump	8 radial pistons, variable flow
Flow @ 2000 psi (13 790 kPa)	35 gpm (133 L/m)
Filter, return oil	10 micron steel enclosed, replaceable element
Screen, pressure oil	50/in. (20/cm) mesh

Hydraulic Cylinders:

	Bore	Stroke	Rod
Loader boom (2)	3.5 in. (89 mm)	30.0 in. (762 mm)	1.75 in. (44 mm)
Loader bucket (1)	4.0 in. (102 mm)	24.4 in. (620 mm)	2.0 in. (51 mm)
Backhoe boom (1)	5.0 in. (127 mm)	42.7 in. (1085 mm)	2.5 in. (64 mm)
Backhoe crowd (1)	4.5 in. (115 mm)	34.5 in. (876 mm)	2.25 in. (57 mm)
Backhoe bucket (1)	3.5 in. (89 mm)	27.4 in. (696 mm)	2.25 in. (57 mm)
Backhoe swing (2)	4.0 in. (102 mm)	9.5 in. (241 mm)	2.0 in. (51 mm)
Backhoe extendible dip- per (1)	2.5 in. (64 mm)	60 in. (1525 mm)	1.25 in. (32 mm)
Backhoe stabilizers (2)	4.0 in. (102 mm)	20.3 in. (516 mm)	2.0 in. (51 mm)
Steering (1) regular axle	2.0 in. (51 mm)	9.5 in. (241 mm)	1.0 in. (25.4 mm)

Tires:

Front	11-16, 12PR, F3 14.5/75-16.1, 10PR, F3 12-16.5, 8 PR, F3
Rear	18.4-28, 12PR, R4 (19.5L-24, 12PR, R4 21L-24, 10PR, R4

Wheel Treads:

Front	68 in. (1730 mm)
Rear	66 in. (1675 mm)

Wheelbase

..... 83 in. (2110 mm)

Axle Ratings: (SAE J43)

Front	10,500 lb. (4763 kg)
Rear	13,660 lb. (6195 kg)

Specifications

610B BACKHOE LOADER

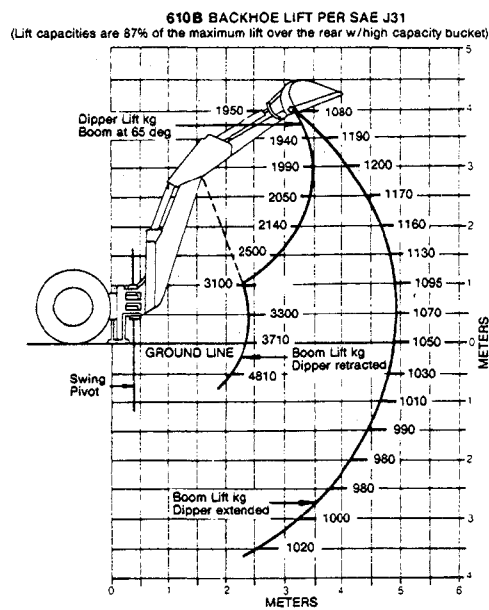
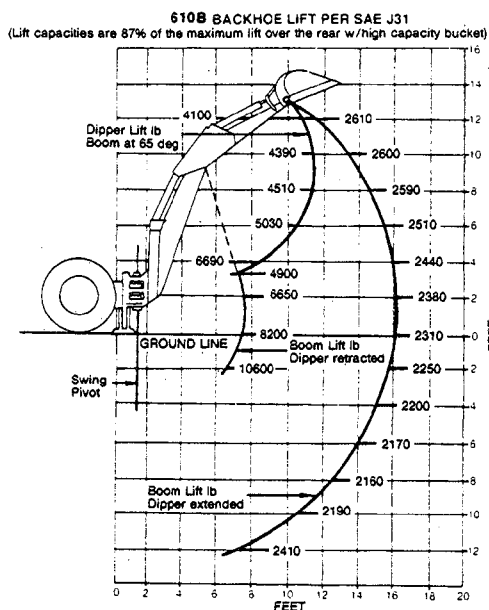
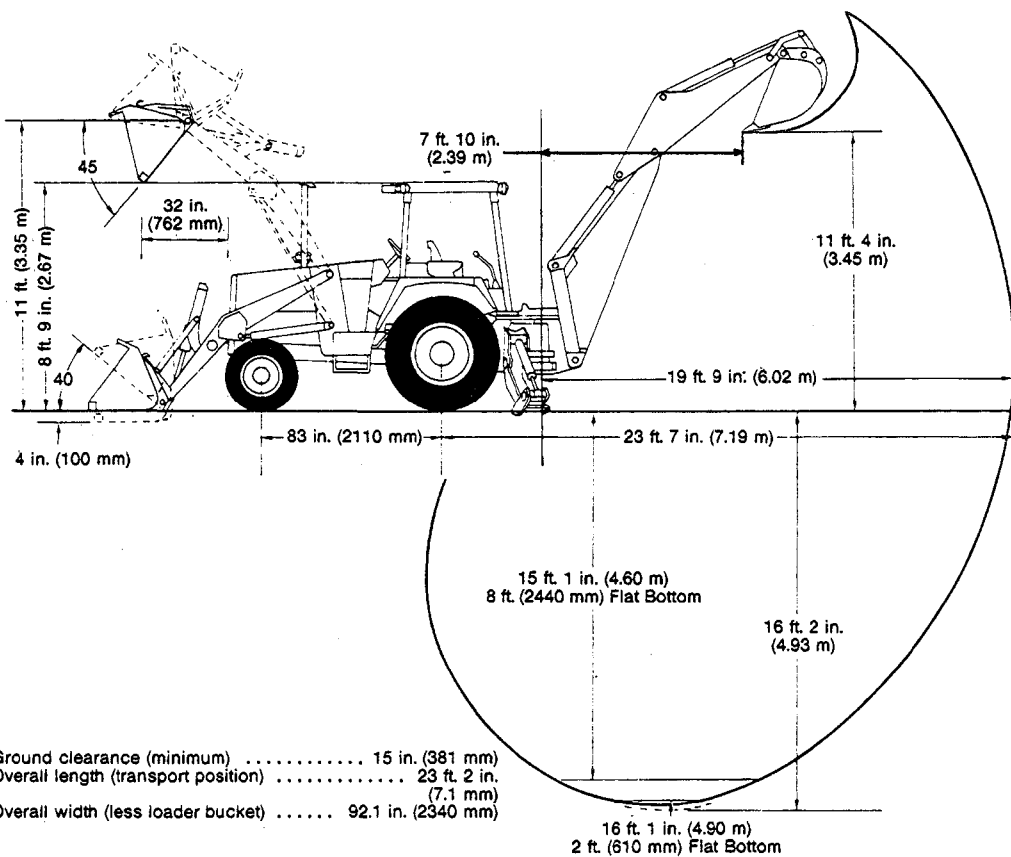

63A;T96260 05T;115 M39 070388

Specifications

Wheelbase:

(Without MFWD) 82.7 in. (2100 mm)
 (With MFWD) 83.3 in. (2116 mm)

Axle Ratings: (SAE J43)

Front 11,700 lb (5300 kg)
 Rear 16,700 lb (7400 kg)

Buckets:

Loader:	Width		Struck Capacity		Heaped Capacity	
	In.	(mm)	Cu. Yd. (m ³)	Cu. Yd. (m ³)	Cu. Yd. (m ³)	Cu. Yd. (m ³)
(Long Lip)	89.4	(2270)	1.05 (0.80)	1.25 (0.96)	1.0 (0.76)	1.3 (1.00)
	92	(2337)	0.88 (0.67)	1.0 (0.76)	1.0 (0.76)	1.3 (1.00)
	92	(2337)	1.07 (0.82)	1.3 (1.00)	1.0 (0.76)	1.3 (1.00)

Backhoe:	In.	(mm)	Cu. Ft. (m ³)		Cu. Ft. (m ³)	
			Cu. Ft. (m ³)	Cu. Ft. (m ³)	Cu. Ft. (m ³)	Cu. Ft. (m ³)
Standard	12	(305)	2.6 (0.07)	3.0 (0.08)	4.5 (0.13)	5.1 (0.14)
	16	(406)	3.7 (0.10)	4.5 (0.13)	5.1 (0.14)	7.5 (0.21)
	18	(457)	4.2 (0.12)	5.1 (0.14)	7.5 (0.21)	10.0 (0.28)
	24	(610)	5.9 (0.17)	7.5 (0.21)	10.0 (0.28)	10.0 (0.28)
	30	(762)	7.5 (0.21)	10.0 (0.28)	10.0 (0.28)	10.0 (0.28)
Heavy duty	18	(457)	4.2 (0.12)	5.1 (0.14)	7.5 (0.21)	10.0 (0.28)
	24	(610)	5.9 (0.17)	7.5 (0.21)	10.0 (0.28)	10.0 (0.28)
	30	(762)	7.5 (0.21)	10.0 (0.28)	10.0 (0.28)	10.0 (0.28)
High Capacity	24	(610)	7.2 (0.20)	8.8 (0.25)	14.5 (0.41)	14.5 (0.41)
	38	(914)	11.2 (0.32)	14.5 (0.41)	14.5 (0.41)	14.5 (0.41)

Drain and Refill Capacities:

	U.S.	Metric
Engine coolant (no heater)	14 qt	13 L
Engine coolant (with heater)	18 qt	17 L
Engine oil (including filter)	9 qt	8.5 L
Transmission-hydraulic system		
(without MFWD)	5.75 gal	22 L
Transmission-hydraulic system		
(with MFWD)	7.25 gal	27 L
Fuel tank	23 gal	87 L
Auxiliary fuel tank	15 gal	57 L
Differential (rear axle)	4.5 gal	17 L
Front axle (MFWD)	7 qt	6.5 L
Front wheel planetary (MFWD)		
(per side)	1.1 qt	1.0 L

Transporting:

SAE operating weight with ROPS 7400 kg
 (16,300 lb)