

**84  
Loader  
Repair**

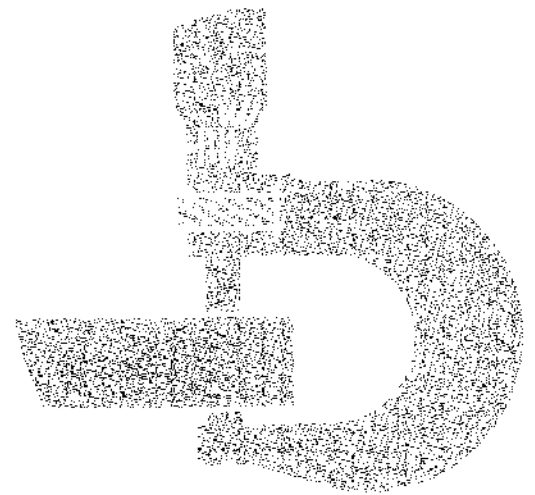

**TECHNICAL MANUAL**

**TM1398 (08MAY90)**

LITHO IN U.S.A.

## FOREWORD

This manual is written for an experienced technician. Essential tools required in performing certain service work are identified in this manual and are recommended for use.

Live with safety: Read the safety messages in the introduction of this manual and the cautions presented throughout the text of the manual.



This is the safety-alert symbol. When you see this symbol on the machine or in this manual, be alert to the potential for personal injury.

Technical manuals are divided in two parts: repair and diagnostics. Repair sections tell how to repair the components. Diagnostic sections help you identify the majority of routine failures quickly.

Information is organized in groups for the various components requiring service instruction. At the beginning of each group are summary listings of all applicable essential tools, service equipment and tools, other materials needed to do the job, service parts kits, specifications, wear tolerances, and torque values.

Binders, binder labels, and tab sets can be ordered by John Deere dealers direct from the John Deere Distribution Service Center.

This manual is part of a total product support program.

### FOS MANUALS—REFERENCE

### TECHNICAL MANUALS—MACHINE SERVICE

### COMPONENT MANUALS—COMPONENT SERVICE

Fundamentals of Service (FOS) Manuals cover basic theory of operation, fundamentals of troubleshooting, general maintenance, and basic type of failures and their causes. FOS Manuals are for training new personnel and for reference by experienced technicians.

Technical Manuals are concise guides for specific machines. Technical manuals are on-the-job guides containing only the vital information needed for diagnosis, analysis, testing, and repair.

Component Technical Manuals are concise service guides for specific components. Component technical manuals are written as stand-alone manuals covering multiple machine applications.

**IMPORTANT: Please remove this page and route through your service department.**

This is a complete revision for TM1398, 84 Loader.

To make miscellaneous additions and corrections.

To update material per earlier and later units throughout manual.

# Contents

## **SECTION I—GENERAL INFORMATION**

- Group I—Safety
- Group II—General Specifications
- Group III—Torque Values
- Group IV— Fuels and Lubricants
- Group V—Inspection Procedures

## **SECTION 01—WHEELS**

- Group 0110—Powdered Wheels and Fastenings

## **SECTION 02—AXLES AND SUSPENSION SYSTEMS**

- Group 0200—Removal and Installation
- Group 0210—Differential or Bevel Drive
- Group 0225—Input Drive Shafts and U-Joints
- Group 0250—Axle Shaft, Bearings, and Reduction Gears

## **SECTION 03—TRANSMISSION**

- Group 0300—Removal and Installation
- Group 0315—Controls Linkage
- Group 0350—Gear, Shafts, Bearings, and Power Shift Clutch
- Group 0360—Hydraulic System

## **SECTION 04—ENGINE**

- Group 0400—Removal and Installation

## **SECTION 05—ENGINE AUXILIARY SYSTEMS**

- Group 0505—Cold Weather Starting Aids
- Group 0510—Cooling System
- Group 0515—Speed Controls and Manual Fuel Shut-off Linkage
- Group 0520—Intake System
- Group 0560—External Fuel Supply Systems

## **SECTION 09—STEERING SYSTEM**

- Group 0960—Hydraulic System

## **SECTION 10—SERVICE BRAKES**

- Group 1011—Active Elements
- Group 1015—Controls Linkage
- Group 1060—Hydraulic System

## **SECTION 11—PARK BRAKE**

- Group 1111—Active Elements
- Group 1115—Controls Linkage

## **SECTION 16—ELECTRICAL SYSTEMS**

- Group 1672—Alternator, Regulator, and Charging System Wiring
- Group 1673—Lighting System
- Group 1674—Wiring Harness and Switches
- Group 1675—Systems Control

## **SECTION 17—FRAME, CHASSIS**

- Group 1740—Frame Installation
- Group 1749—Chassis Weights

## **SECTION 18—OPERATOR'S STATION**

- Group 1800—Removal and Installation
- Group 1810—Operator Enclosure
- Group 1821—Seat and Seat Belt
- Group 1830—Heating and Air Conditioning

## **SECTION 19—SHEET METAL AND STYLING**

- Group 1910—Hood or Engine

## **SECTION 31—LOADER**

- Group 3102—Bucket
- Group 3115—Controls Linkage
- Group 3140—Frames
- Group 3160—Hydraulic System

## **SECTION 99—DEALER FABRICATED TOOLS**

- Group 9900—Dealer Fabricated Tools

## **Alphabetical Index**

*All information, illustrations and specifications in this manual are based on the latest information available at the time of publication. The right is reserved to make changes at any time without notice.*

TM1398-19-08MAY90

COPYRIGHT® 1990  
DEERE & COMPANY  
Moline, Illinois  
All rights reserved  
A John Deere ILLUSTRATION™ Manual  
Previous Editions  
Copyright® 1987 Deere & Company

**Thanks very much for your reading,  
Want to get more information,  
Please click here, Then get the complete  
manual**

**JustClickHere** 

**NOTE:**

**If there is no response to click on the link above,  
please download the PDF document first, and then  
click on it.**

**Have any questions please write to me:  
[admin@servicemanualperfect.com](mailto:admin@servicemanualperfect.com)**

*Contents*

# Section I GENERAL INFORMATION

## Contents

### Page

#### Group I—Safety

Park Machine Safely . . . . .	I-I-3
Service Machine Safely . . . . .	I-I-4
Use Seat Belt . . . . .	I-I-6
Live with Safety . . . . .	I-I-9

#### Group II—General Specifications

Machine . . . . .	I-II-1
Engine . . . . .	I-II-2
Fluid Capacities . . . . .	I-II-4

#### Group III—Torque Values

#### Group IV— Fuels and Lubricants

Engine Oil . . . . .	I-IV-2
Transmission Oil . . . . .	I-IV-3
Differential Oil . . . . .	I-IV-4
Hydraulic Oil . . . . .	I-IV-5
Grease . . . . .	I-IV-6

#### Group V—Inspection Procedures

PIP I . . . . .	I-V-6
PIP II . . . . .	I-V-8

*Contents*



### **HANDLE FLUIDS SAFELY—AVOID FIRES**

When you work around fuel, do not smoke or work near heaters or other fire hazards.

Store flammable fluids away from fire hazards. Do not incinerate or puncture pressurized containers.

Make sure machine is clean of trash, grease, and debris.

Do not store oily rags; they can ignite and burn spontaneously.



O53,FLAME -19-26JAN90

-JUN-29AUG88

TS227

### **PREVENT BATTERY EXPLOSIONS**

Keep sparks, lighted matches, and open flame away from the top of battery. Battery gas can explode.

Never check battery charge by placing a metal object across the posts. Use a volt-meter or hydrometer.

Do not charge a frozen battery; it may explode. Warm battery to 16°C (60°F).



O53,SPARKS -19-26JAN90

-JUN-29AUG88

TS204

### **PREPARE FOR EMERGENCIES**

Be prepared if a fire starts.

Keep a first aid kit and fire extinguisher handy.

Keep emergency numbers for doctors, ambulance service, hospital, and fire department near your telephone.

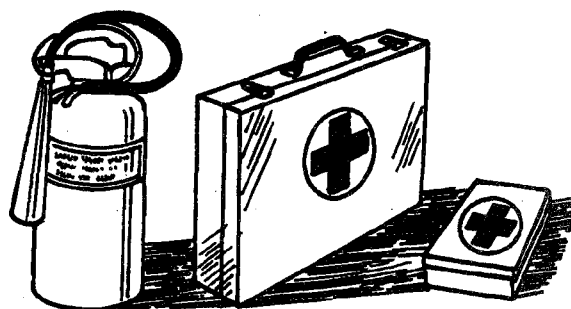

O53,FIRE2 -19-26JAN90

-JUN-29AUG88

TS291

## PREVENT ACID BURNS

Sulfuric acid in battery electrolyte is poisonous. It is strong enough to burn skin, eat holes in clothing, and cause blindness if splashed into eyes.

Avoid the hazard by:

1. Filling batteries in a well-ventilated area.
2. Wearing eye protection and rubber gloves.
3. Avoiding breathing fumes when electrolyte is added.
4. Avoiding spilling or dripping electrolyte.
5. Use proper jump start procedure.

If you spill acid on yourself:

1. Flush your skin with water.
2. Apply baking soda or lime to help neutralize the acid.
3. Flush your eyes with water for 10—15 minutes. Get medical attention immediately.

If acid is swallowed:

1. Drink large amounts of water or milk.
2. Then drink milk of magnesia, beaten eggs, or vegetable oil.
3. Get medical attention immediately.

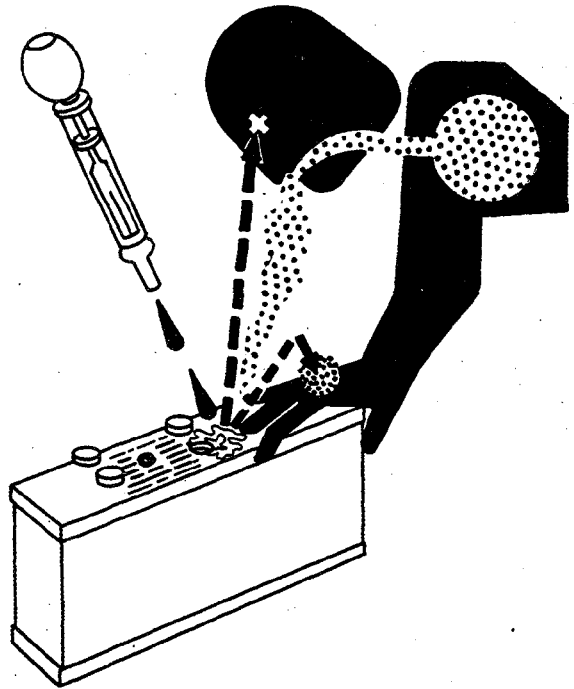

O53, POISON -19-26JAN90

TS203 -UN-23AUG88

### AVOID HIGH-PRESSURE FLUIDS

Escaping fluid under pressure can penetrate the skin causing serious injury.

Avoid the hazard by relieving pressure before disconnecting hydraulic or other lines. Tighten all connections before applying pressure.

Search for leaks with a piece of cardboard. Protect hands and body from high pressure fluids.

If an accident occurs, see a doctor immediately. Any fluid injected into the skin must be surgically removed within a few hours or gangrene may result. Doctors unfamiliar with this type of injury may call the Deere & Company Medical Department in Moline, Illinois, or other knowledgeable medical source.

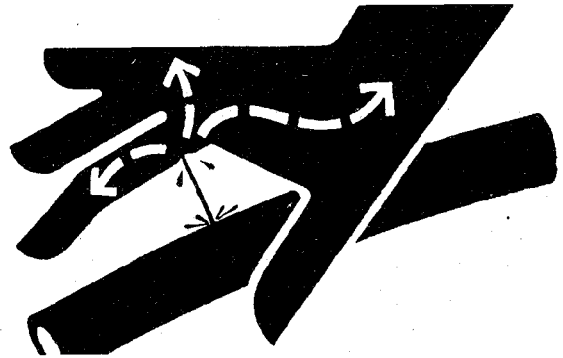

-JUN-29AUG88

X9811

O53,FLUID -19-26JAN90

### PARK MACHINE SAFELY

Before working on the machine:

- Lower all equipment to the ground.
- Stop the engine and remove the key.
- Disconnect the battery ground strap.
- Hang a "DO NOT OPERATE" tag in operator station.

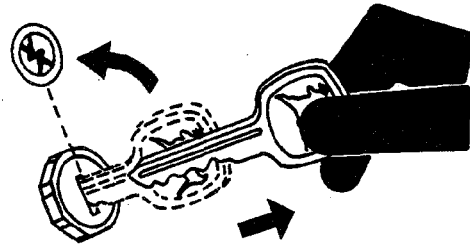

-JUN-24MAY89

TS230

O53,PARK -19-26JAN90

### SUPPORT MACHINE PROPERLY

Always lower the attachment or implement to the ground before you work on the machine. If you must work on a lifted machine or attachment, securely support the machine or attachment.

Do not support the machine on cinder blocks, hollow tiles, or props that may crumble under continuous load. Do not work under a machine that is supported solely by a jack. Follow recommended procedures in this manual.

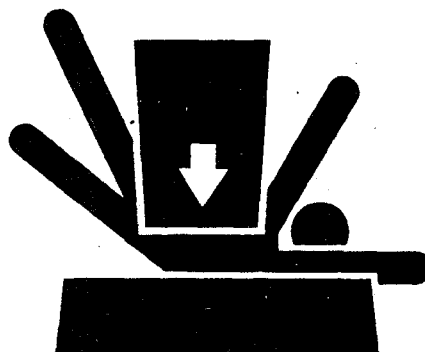

O53,LOWER -19-26JAN90

-UN-23AUG88  
TS229

### WEAR PROTECTIVE CLOTHING

Wear close fitting clothing and safety equipment appropriate to the job.

Prolonged exposure to loud noise can cause impairment or loss of hearing.

Wear a suitable hearing protective device such as earmuffs or earplugs to protect against objectionable or uncomfortable loud noises.

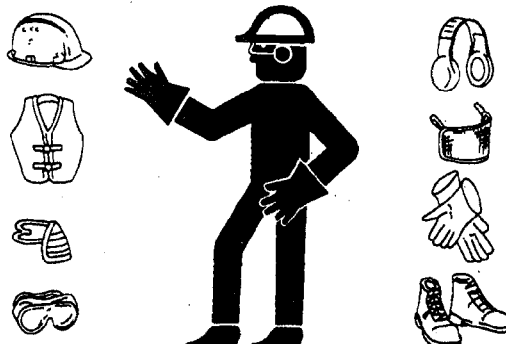

O53,WEAR -19-26JAN90

-UN-23AUG88  
TS206

### SERVICE MACHINES SAFELY

Tie long hair behind your head. Do not wear a necktie, scarf, loose clothing, or necklace when you work near machine tools or moving parts. If these items were to get caught, severe injury could result.

Remove rings and other jewelry to prevent electrical shorts and entanglement in moving parts.

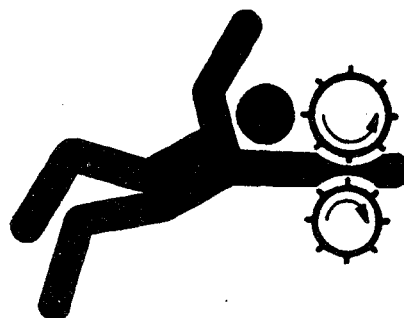

O53,LOOSE -19-26JAN90

-UN-23AUG88  
TS228

### WORK IN VENTILATED AREA

Engine exhaust fumes can cause sickness or death. If it is necessary to run an engine in an enclosed area, remove the exhaust fumes from the area with an exhaust pipe extension.

If you do not have an exhaust pipe extension, open the doors and get outside air into the area.

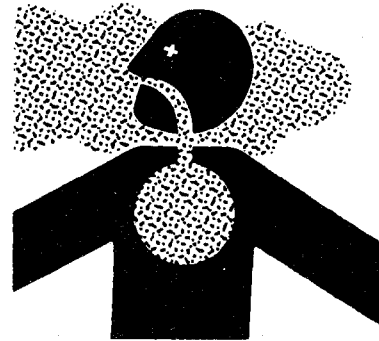

O53,AIR -19-26JAN90

TS220 -UN-23AUG88

### UNDERSTAND CORRECT SERVICE

Illuminate your work area adequately but safely. Use a portable safety light for working inside or under the machine. Make sure the bulb is enclosed by a wire cage. The hot filament of an accidentally broken bulb can ignite spilled fuel or oil.

Catch draining fuel, oil, or other fluids in suitable containers. Do not use food or beverage containers that may mislead someone into drinking from them. Wipe up spills at once.

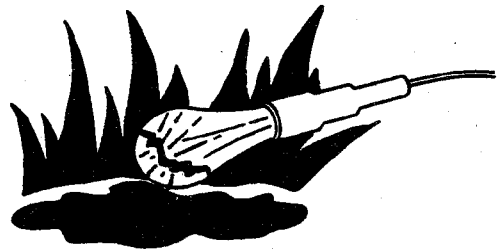

O53,LIGHT -19-26JAN90

TS223 -UN-23AUG88

### REPLACE SAFETY SIGNS

Replace missing or damaged safety signs. See the machine operator's manual for correct safety sign placement.



O53,SIGNS1 -19-26JAN90

TS201 -UN-23AUG88

### USE PROPER LIFTING EQUIPMENT

Lifting heavy components incorrectly can cause severe injury or machine damage.

Follow recommended procedure for removal and installation of components in the manual.

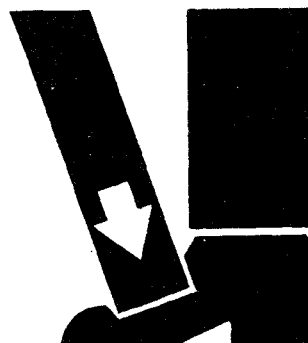

O53,LIFT -19-26JAN90

TS226 -UN-23AUG88

### KEEP ROPS INSTALLED PROPERLY

Make certain all parts are reinstalled correctly if the roll-over protective structure (ROPS) is loosened or removed for any reason. Tighten mounting bolts to proper torque.

The protection offered by ROPS will be impaired if ROPS is subjected to structural damage, is involved in an overturn incident, or is in any way altered by welding, bending, drilling, or cutting. A damaged ROPS should be replaced, not reused.

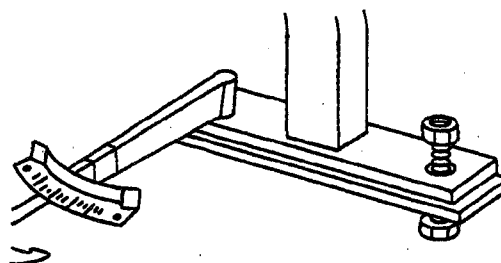

O53,ROPS3 -19-26JAN90

TS212 -UN-23AUG88

### USE SEAT BELT PROPERLY

Use a seat belt when you operate with a roll-over protective structure (ROPS) to minimize chance of injury from an accident such as an overturn.

Do not use a seat belt if operating without a ROPS.

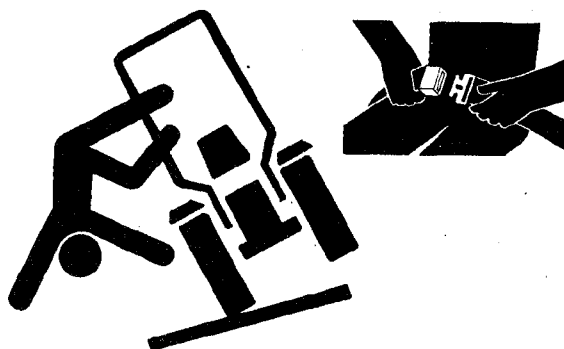

O53,ROPS1 -19-26JAN90

TS205 -UN-23AUG88

## SERVICE TIRES SAFELY

Explosive separation of a tire and rim parts can cause serious injury or death.

Do not attempt to mount a tire unless you have the proper equipment and experience to perform the job.

Always maintain the correct tire pressure. Do not inflate the tires above the recommended pressure.

When inflating tires, use a clip-on chuck and extension hose long enough to allow you to stand to one side and NOT in front of or over the tire assembly. Use a safety cage if available.

Check wheels for low pressure, cuts, bubbles, damaged rims or missing lug bolts and nuts.

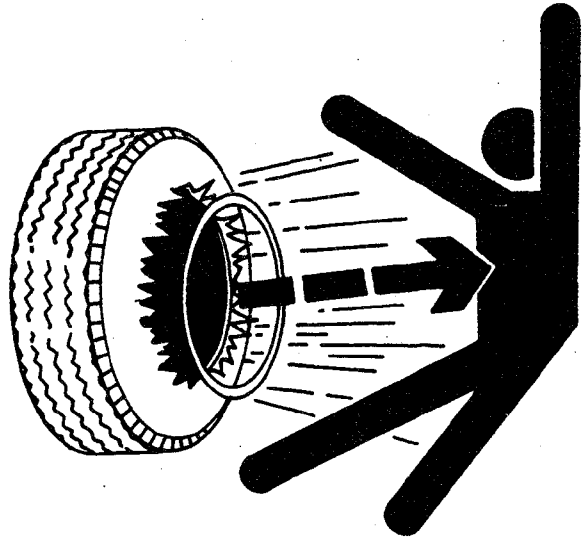

TS211 -UN-23AUG88

O53,RIM -19-26JAN90

## AVOID HARMFUL ASBESTOS DUST

Avoid breathing dust that may be generated when handling components containing asbestos fibers. Inhaled asbestos fibers may cause lung cancer.

Components in John Deere products that may contain asbestos fibers are brake pads, brake band and lining assemblies, clutch plates, and some gaskets. The asbestos used in these components is usually found in a resin or sealed in some way. Normal handling is not hazardous as long as airborne dust containing asbestos is not generated.

Avoid creating dust. Never use compressed air for cleaning. Avoid brushing or grinding of asbestos containing materials. When servicing, wear an approved respirator. A special vacuum cleaner is recommended to clean asbestos. If not available, wet the asbestos containing materials with a mist of oil or water.

Keep bystanders away from the area.

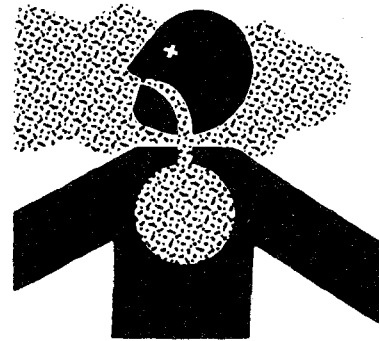

TS220 -UN-23AUG88

O53,DUST -19-26JAN90

### WORK IN CLEAN AREA

Before starting a job:

- Clean work area and machine.
- Make sure you have all necessary tools to do your job.
- Have the right parts on hand.
- Read all instructions thoroughly; do not attempt shortcuts.

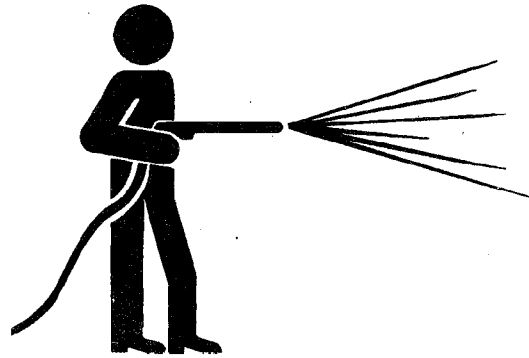

O53,CLEAN -19-26JAN90

T6642EJ -UN-18OCT88

### USE TOOLS PROPERLY

Use tools appropriate to the work. Makeshift tools, parts, and procedures will not make good repairs.

Use pneumatic and electric tools only to loosen threaded parts and fasteners. Never use such tools to tighten fasteners, especially on light alloy parts.

Use only replacement parts meeting John Deere specifications.

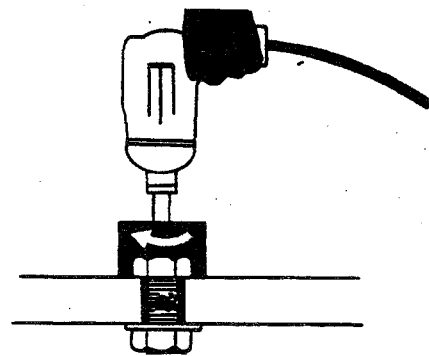

O53,REPAIR -19-26JAN90

TS221 -UN-29AUG88

### DISPOSE OF FLUIDS PROPERLY

Improperly disposing of fluids can harm the environment and ecology. Before draining any fluids, find out the proper way to dispose of waste from your local environmental agency.

Avoid pouring oil into the ground, down a drain, or into a stream, pond, or lake. Observe relevant environmental protection regulations when disposing of oil, fuel, coolant, brake fluid, filters, batteries, and other harmful waste.

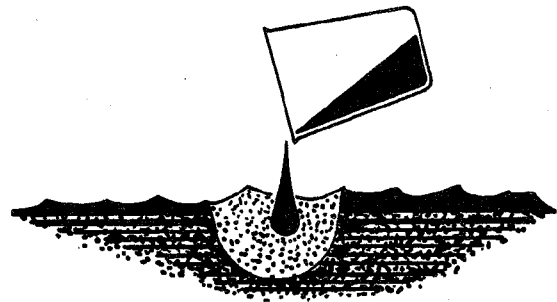

O53,DRAIN -19-26JAN90

TS222 -UN-29AUG88



**LIVE WITH SAFETY**

Before returning machine to customer, make sure machine is functioning properly, especially the safety systems. Install all guards and shields.



O53,LIVE -19-26JAN90

TS231 -19-07OCT88

*Safety/Live with Safety*

**Group II  
General Specifications**

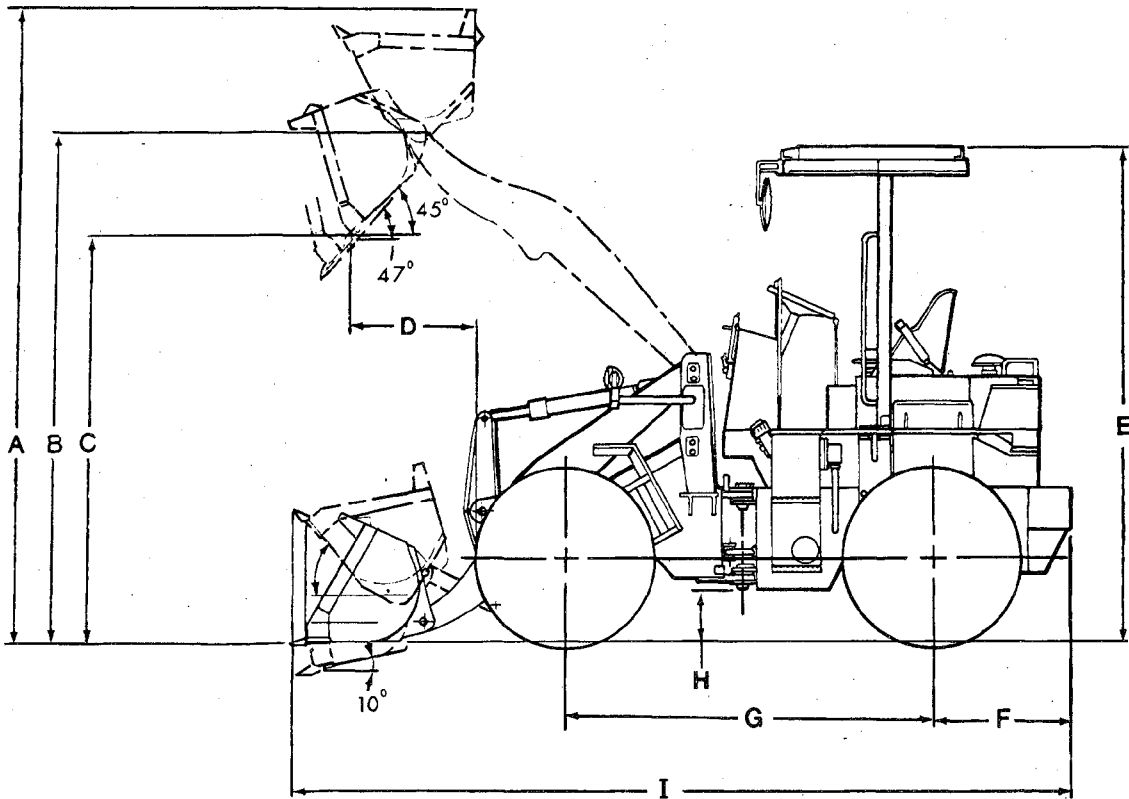

T6451BR -JUN-24MAY89

A—Overall operating height (boom full raise) .....	3.8 m (12 ft 6 in.)
B—Bucket hinge height .....	3.0 m (9 ft 11 in.)
C—Dump height .....	2.4 m (7 ft 10 in.)
D—Dump reach .....	795 mm (2 ft 7 in.)
E—Overall height .....	2.9 m (9 ft 6 in.)
F—Overhang .....	820 mm (2 ft 8 in.)
G—Wheelbase .....	2.2 m (7 ft 3 in.)
H—Ground clearance .....	310 mm (1 ft.)
I—Overall length .....	4.6 m (15 ft 3 in.)

*NOTE: All dimensions are less cutting edge and teeth.*

Standard operating weight (with ROPS canopy) ..... 4 900 kg (10,800 lb)

05T,115,K26 -19-02APR90

General Specifications/Engine

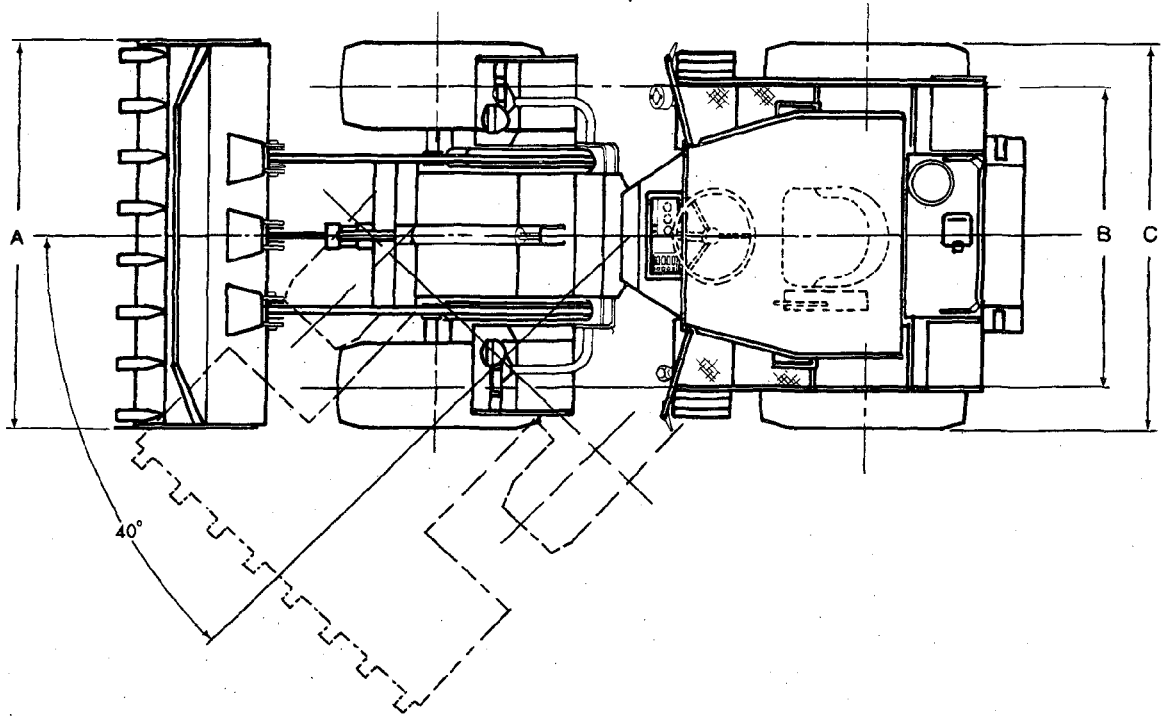

A—Overall width bucket .....	2.1 m (6 ft 10 in.)
B—Tread (center of tire to center of tire) .....	1.5 m (5 ft 1 in.)
C—Overall width (outside of tire to outside) .....	2.0 m (6 ft. 7 in.)

T6451BS1 -JN-17MAY89

05T,115,K23 -19-02APR90