

**John Deere
670A and 672A
Motor Grader
Repair**

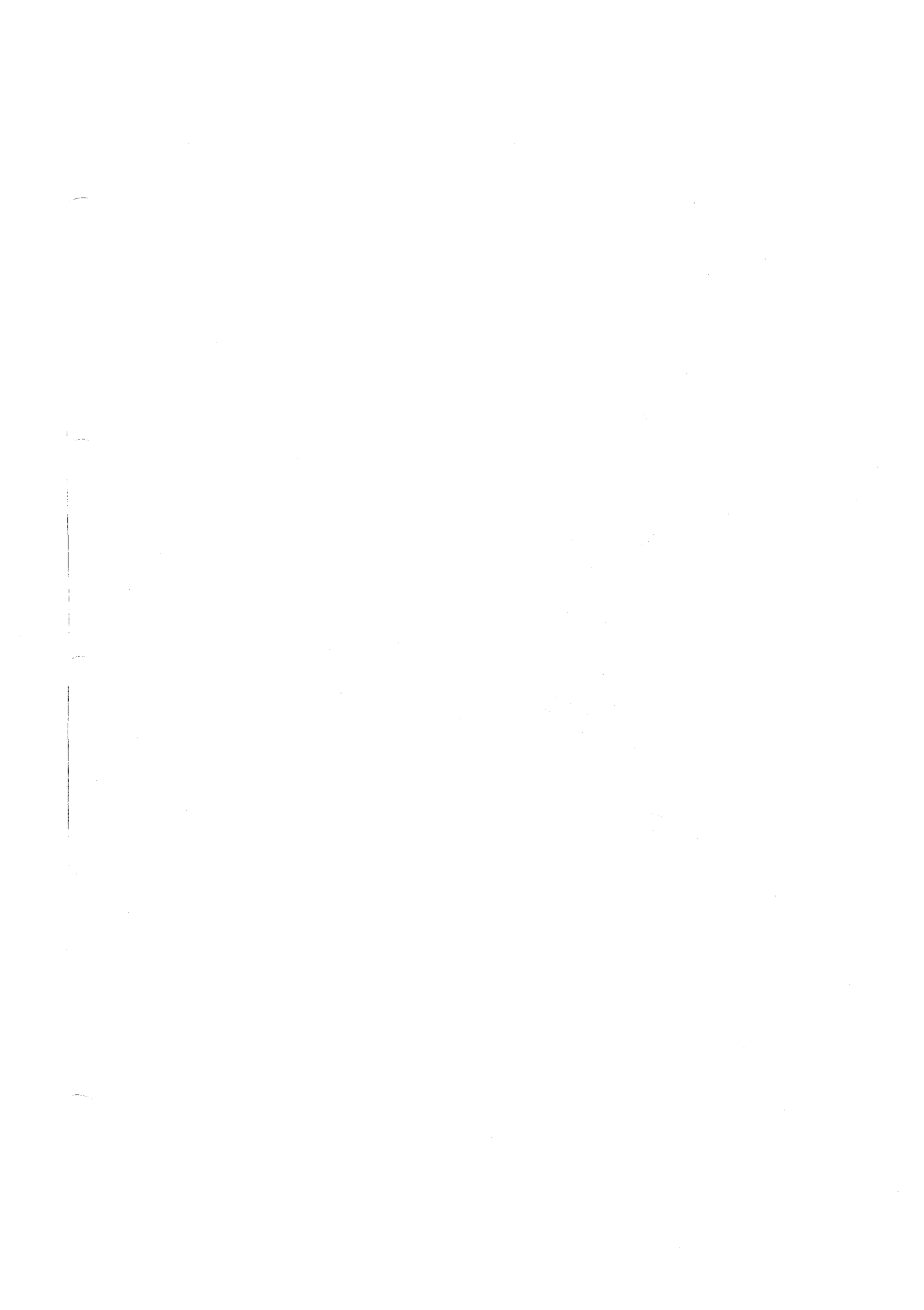

TECHNICAL MANUAL

TM-1188 (Dee-87)
LITHO IN U.S.A.



TO JOHN DEERE DEALERS

IMPORTANT: Please remove this page and route through your service department.

This is a complete revision for TM-1188, JD670-A and JD672-A Motor Graders Repair.

Binder and tabs from old manual may be saved and used with this bound manual.

The new pages are dated (Dec-87). Listed below is a brief explanation of "WHAT" was changed and "WHY" it was changed.

This manual was revised:

- To clarify assembly of clutch plate disks.
- To update engine section and add engine CTM-4.
- To add Weather Pack™ electrical connectors information.
- To update hydraulic section and add radial piston pump CTM-7.
- To add serial number breaks and new art on pump drive assemblies.
- To add information on cylinder piston cap seals.

**Thanks very much for your reading,
Want to get more information,
Please click here, Then get the complete
manual**

JustClickHere 

NOTE:

**If there is no response to click on the link above,
please download the PDF document first, and then
click on it.**

**Have any questions please write to me:
admin@servicemanualperfect.com**

JD670-A AND JD672-A MOTOR GRADERS

Technical Manual
TM-1188 (Dec-87)

SECTION AND GROUP CONTENTS

SECTION I - GENERAL INFORMATION

- Group I - Contents (not used)
- Group II - Introduction and Safety Information
- Group III - General Specifications
- Group IV - Predelivery, Delivery and After-Sales Services
- Group V - Lubrication

SECTION 1 - WHEELS

- Group 0110 - Powered Wheels and Fastenings
- Group 0120 - Non-Powered Wheels and Fastenings
- Group 0199 - Specifications and Special Tools

SECTION 2 - AXLES AND SUSPENSION SYSTEMS

- Group 0201 - Drive Axle Housing and Support
- Group 0210 - Differential or Bevel Drive
- Group 0250 - Axle Shafts, Bearing and Reduction Gears
- Group 0260 - Hydraulic System
- Group 0299 - Specifications and Special Tools

SECTION 3 - TRANSMISSION

- Group 0315 - Controls
- Group 0341 - Housings and Covers
- Group 0350 - Gears, Shafts, Bearings and Power Shift Clutch
- Group 0360 - Hydraulic System
- Group 0370 - Clutch Disconnect and Controls
- Group 0399 - Specifications and Special Tools

SECTION 4 - ENGINE

- Group 0400 - Removal and Installation
- Group 0422 - Starting Motor and Fastenings
- Group 0499 - Specifications and Special Tools

SECTION 5 - ENGINE AUXILIARY SYSTEMS

- Group 0505 - Cold Weather Starting Aids
- Group 0510 - Cooling Systems
- Group 0515 - Speed Controls
- Group 0520 - Intake System
- Group 0540 - Mounting Frame
- Group 0560 - External Fuel Supply Systems
- Group 0599 - Specifications and Special Tools

SECTION 8 - TRANSFER DRIVE

- Group 0841 - Housings and Covers
- Group 0851 - Gears, Shafts, Bearings
- Group 0899 - Specifications and Special Tools

SECTION 9 - STEERING SYSTEM

- Group 0920 - Power Steering
- Group 0960 - Hydraulic System
- Group 0999 - Specifications and Special Tools

SECTION 10 - SERVICE BRAKES

- Group 1011 - Active Elements
- Group 1015 - Controls Linkage
- Group 1060 - Hydraulic System
- Group 1099 - Specifications and Special Tools

SECTION 11 - PARKING-EMERGENCY BRAKES

- Group 1111 - Active Elements
- Group 1115 - Controls Linkage
- Group 1199 - Specifications and Special Tools

SECTION 15 - EQUIPMENT ATTACHING

- Group 1511 - Drawbar
- Group 1599 - Specifications and Special Tools

Continued on next page

All information, illustrations and specifications contained in this technical manual are based on the latest information available at the time of publication. The right is reserved to make changes at any time without notice.

Copyright© 1987
DEERE & COMPANY
Moline, Illinois
All Rights Reserved

SECTION 16 - ELECTRICAL SYSTEMS

- Group 1671 - Batteries, Support and Cables
- Group 1672 - Alternator, Regulator and Charging System Wiring
- Group 1673 - Lighting System
- Group 1674 - Wiring Harness and Switches
- Group 1675 - System Controls
- Group 1676 - Instruments and Indicators
- Group 1699 - Specifications and Special Tools

SECTION 17 - FRAME, CHASSIS OR SUPPORTING STRUCTURE

- Group 1740 - Frame Installation
- Group 1746 - Frame Bottom Guards
- Group 1747 - Bumpers, Vehicle
- Group 1799 - Specifications and Special Tools

SECTION 18 - OPERATOR'S STATION

- Group 1810 - Operator Enclosure
- Group 1821 - Seat and Seat Belt
- Group 1822 - Steps and Handholds
- Group 1830 - Heating and Air Conditioning
- Group 1899 - Specifications and Special Tools

SECTION 19 - SHEET METAL AND STYLING

- Group 1910 - Hood or Engine Enclosure
- Group 1913 - Miscellaneous Shields
- Group 1921 - Grille and Grille Housing

SECTION 20 - SAFETY, CONVENIENCE AND MISCELLANEOUS

- Group 2002 - Mirror
- Group 2003 - Fire Extinguisher
- Group 2004 - Horn
- Group 2006 - Cigar Lighter

SECTION 21 - MAIN HYDRAULIC SYSTEM

- Group 2160 - Hydraulic System
- Group 2199 - Specifications and Special Tools

SECTION 34 - GRADING DEVICE

- Group 3401 - Blade
- Group 3415 - Controls Linkage
- Group 3440 - Frames
- Group 3450 - Circle Gear Box
- Group 3460 - Hydraulic System
- Group 3499 - Specifications and Special Tools

SECTION 42 - GROUND CONDITIONING TOOL

- Group 4201 - Blades, Teeth, Shanks, Etc.
- Group 4215 - Controls Linkage
- Group 4240 - Frames
- Group 4260 - Hydraulic System
- Group 4299 - Specifications and Special Tools

Group II INTRODUCTION AND SAFETY INFORMATION

INTRODUCTION

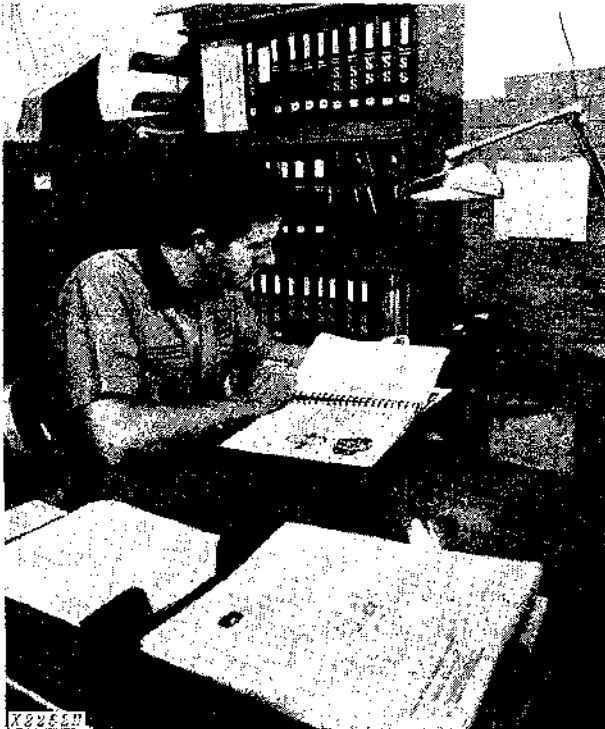

Use FOS Manuals for Reference

This technical manual is part of a twin concept of service:

The two kinds of manuals work as a team to give you both the general background and technical details of shop service.

•FOS Manuals - For Reference

Fundamentals of Service (FOS) Manuals cover basic theory of operation, fundamentals of troubleshooting, general maintenance, and basic types of failure and their causes. FOS Manuals are for training new personnel and for reference by experienced service technicians.



When a service technician should refer to a FOS Manual for more information, a FOS symbol like the one at the left is used in the technical manual.

•Technical Manuals - For Actual Service

Technical manuals are concise service guides for specific machines. Technical manuals are on-the-job guides containing only the vital information needed by an experienced service technician.



Use Technical Manuals for Actual Service

This technical manual was written for you - an experienced service technician. Keep it in a permanent binder in the shop where it is handy. Read it when you need to know correct service procedures or specifications.

Some features of this manual:

- Inside front cover - "Table of Contents".
- Section I - General specifications and services.
- Sections 1 through 46 - Removal, repair, testing (components removed), installation, and adjustment.
- Section 90 - Detailed explanation of system operation, diagnosis, visual inspection, testing, and adjustments.
- Specifications are listed and illustrated at the end of each section.

MAINTENANCE WITHOUT ACCIDENT WORK SAFELY



T27396N

 This safety symbol is used for important safety messages. When you see this symbol, follow the safety message to avoid personal injury.

**EVERY EMPLOYER HAS A
SAFETY PROGRAM. KNOW
WHAT IT IS!**

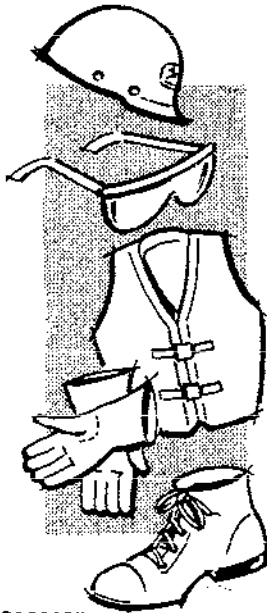

T27501N

See your shop supervisor for specific instructions on a job, and the safety equipment required.

For instance, you may need: Hard hat, safety shoes, safety goggles, heavy gloves, reflector vest, ear protectors, respirator.



T27502N

BE ALERT!

Plan ahead—work safely—know how to use a first-aid kit and a fire extinguisher—and where to get assistance.

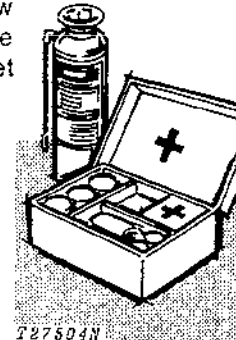

T27504N

Maintenance Area

Make sure the maintenance area has enough ventilation.

Keep the maintenance area **CLEAN AND DRY**. Oily and wet floors are slippery. Greasy rags are a fire hazard. Wet spots are dangerous when working with electrical equipment.

Keep starting aids in a cool, well-ventilated place, out of reach of unauthorized personnel.

MAINTENANCE WITHOUT ACCIDENT

AVOID FIRE HAZARDS—

Fuel Is Dangerous!

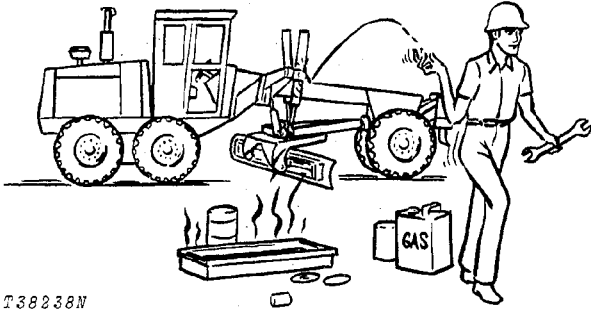

Do not smoke while putting fuel in the fuel tank.

Do not smoke while working with material that will start on fire easily.

Stop the engine before filling the fuel tank.

If the engine is hot, use care when putting fuel in the fuel tank.

Do not use gasoline or diesel fuel for cleaning parts. Use solvents that will not start on fire.

Battery Gas Is Highly Flammable!

When charging batteries, be sure there is enough ventilation.

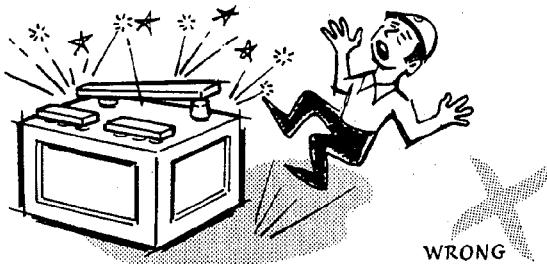

Do not check the battery charge by putting metal objects across the posts.

Do not let sparks or open flame near batteries.

Do not smoke near battery.

Flame Is Not a Flashlight!

NEVER USE OPEN FLAME AROUND THE MACHINE.

KNOW WHERE FIRE EXTINGUISHERS ARE KEPT!

Litho in U.S.A.

UNDER ALL MAINTENANCE CONDITIONS—

Do not work on the equipment unless you are approved to do so. Then be sure you know the safe and correct procedure.

Never work on equipment while it is being operated.

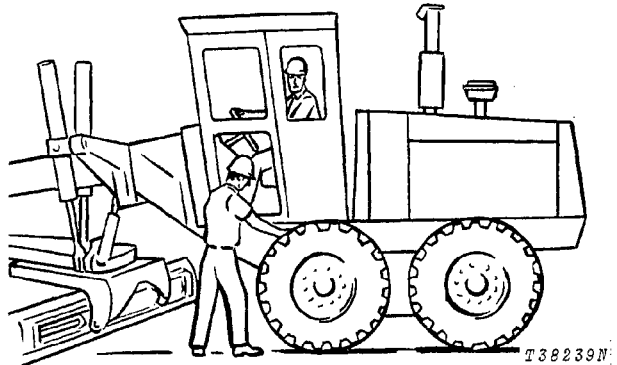

When the engine is running, avoid working on equipment.

If you must work on the machine with the engine running, ALWAYS USE TWO service technicians. One must be at the controls. The other must be within sight of the operator.

KEEP HANDS AWAY FROM MOVING PARTS

Put a support under all raised equipment.

Never work under a raised blade, ripper, or scarifier.

Lower all equipment to the ground.

If the machine is on a slope, use blocks to hold it in place.

Do not lift heavy parts by yourself. Use hoisting equipment for this.

TAKE CARE! WATCH OUT FOR OTHER PEOPLE IN THE AREA

When drilling, grinding, or hammering metal, wear safety glasses.

BE CAREFUL DURING SERVICE AND REPAIR

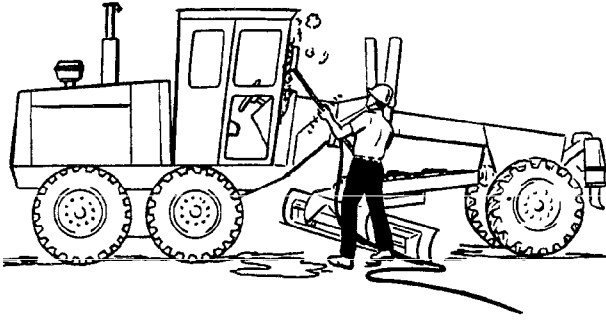

T38242N

Keep ALL equipment free of dirt and oil.

Clean oil, grease, mud, ice or snow from the operator's station, steps and hand rails.

When getting the engine ready for storage, remember that inhibitor changes easily into gas and is dangerous. After adding the inhibitor, seal and tape openings. When you are not using the inhibitor, keep the can tightly closed.

Do not remove the radiator cap unless you can hold your hand on the radiator tank. First, loosen the cap slowly to the stop. Then release all pressure in the cooling system before removing the cap.

Check the exhaust system regularly for leaks.

Release hydraulic pressure before working on the hydraulic system. Stop the engine. Lower all equipment to the ground. Move the control levers until the equipment does not move.

When checking hydraulic pressure, be sure to use the correct test gauge.

Before working on the fuel system, close the fuel shutoff valve.

Before working on the electrical system, or making a major overhaul, disconnect the batteries.

KNOW EQUIPMENT IS READY!

Check all guards, shields, and safety bars. Every one must be in place and tight.

CHECK IT OUT!

- GUARDS
- SHIELDS
- SAFETY BARS
- ROLL-OVER PROTECTIVE STRUCTURES
- SEAT BELTS, ETC.

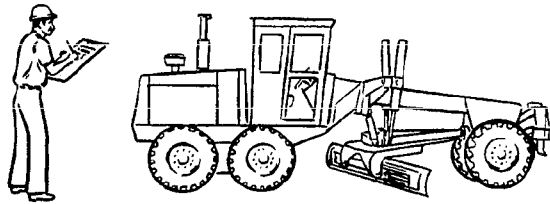

T38243N

Carefully inspect all systems for leaks.

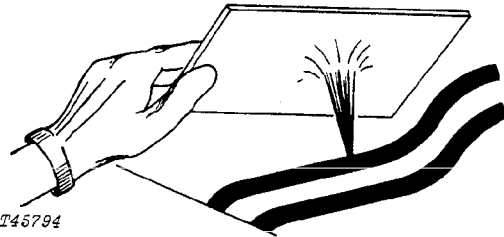

T45794

Use a piece of cardboard or wood, rather than hands, to search for suspected leaks.

Escaping fluid under pressure can penetrate the skin.

If injured by escaping fluid, see a doctor at once.

Group III

GENERAL SPECIFICATIONS

(Specifications and design subject to change without notice. Wherever applicable, specifications are in accordance with ICED and SAE Standards. Except where otherwise noted, these specifications are based on a unit equipped with 13.00-24, 12 ply rating, tubeless tires, 12 ft. (3.66 m) moldboard, and standard equipment. Weights include lubricants, coolants, full fuel tank and 175 lb. (79 kg) operator.)

Power

(at 2300 engine rpm):	SAE	DIN
Gross	135 hp (100.7 kW)	
Net	125 hp (93.2 kW)	126.7 PS

Net engine flywheel power is for an engine equipped with fan, air cleaner, water pump, lubricating oil pump, fuel pump, alternator, and muffler. The gross engine power is without fan. Flywheel power ratings are under SAE standard conditions of 500 ft. altitude and 85°F temperature, and DIN 70 020 conditions (non-corrected). No derating is required up to 10,000 ft. (3000 m) altitude.

Engine: John Deere turbocharged diesel, vertical 6-cylinder, valve-in-head, 4-stroke cycle.
 Bore and stroke 4.19x5 in. (106.5x127 mm)
 Piston displacement 414 cu. in. (6784 cm³)
 Compression ratio 16.2 to 1
 Maximum torque @ 1300 rpm . . 372 lb.-ft. (504 Nm)
 (51.4 kg/m)
 NACC or AMA (U.S. Tax) horsepower 42.1
 Main bearings 7
 Lubrication Pressure system w/full-flow filter
 Cooling . Pressurized, w/thermostat and fixed bypass
 Fan Suction
 Air cleaner w/restriction indicator Dry
 Electrical system 24 volt w/alternator
 Batteries (2) 12 volt. Reserve capacity: 180 minutes

Transmission Direct drive full Power Shift with planetary gear reductions. Foot inching pedal.

Travel Speeds (2300 engine rpm, no tire slip):

Shift Lever Position	Forward		Reverse	
	mph	km/h	mph	km/h
1	2.3	3.6	2.8	4.5
2	3.2	5.1	3.9	6.3
3	4.8	7.8	5.9	9.5
4	6.3	10.1	7.6	12.3
5	8.2	13.2		
6	10.5	17.0		
7	14.1	22.8		
8	23.9	38.4		

Differential Lock Foot-operated, hydraulically actuated

Front Drive: (JD672-A only)

Hydrostatic motor in each wheel controlled through a flow divider to provide optimum traction. Free-wheeling in gears 5 through 8. Switch controlled for two modes of operation.

Pump 5.43 cu. in. (89 cm³) variable displacement pump driving a 2.03 cu. in. (33 cm³) reversible motor in each wheel.

Rear Drive... Inboard planetary final drives with heat-treated, splined steel torque shafts. Oscillating welded construction tandems; nodular cast sprockets driving 2 in. (51 mm) pitch roller chain in oil bath.

Front Axle: Fabricated steel box-frame with steel spindles
 Total oscillation..... 30 deg.
 Wheel lean range (either direction) 20 deg.

Steering:
 Front... Full hydraulic power system. Steering capabilities without power
 Rear...Hydraulically articulated frame steering (25 deg. left or right)
 Minimum turning radius
 (JD670-A) 22 ft. (6.7 m)
 Minimum turning radius
 (JD672-A) 22 ft. 6 in. (6.86 m)

Brakes:
 Service... Foot-operated, hydraulically-actuated, wet-disk, effective on 4 tandem wheels
 Parking Foot-operated, mechanical, dry-disk, effective on 4 tandem wheels
 Hydraulic System: Closed-center
 Pressure controlled variable-displacement pump ... 35 gpm (132 L/min) @ 2300 engine rpm

Blade:
 Length 12 ft. (3.66 m)
 Height 24 in. (610 mm)
 Thickness 0.88 in. (22 mm)

Blade Range:
 Lift above ground 1 ft. 4.10 in. (409 mm)
 Blade side shift:
 Right or left 2 ft. 2.9 in. (683 mm)
 Shoulder reach outside wheels:
 Right or left 7 ft. (2.13 m)
 Pitch at ground line 44 deg. forward
 10 deg. back

Blade Lifting Mechanism:
 Control Dual-lever, hydraulic w/float position

Lift Arms: Nodular cast
 Positions 7
 Control Hydraulic, foot operated

Circle: Fabricated steel angle construction
 Circle diameter 4 ft. 10 in. (1.47 m)
 Rotation 360 deg.
 Drive...Hydraulic motor and worm gear w/positive position lock
 Sideshift, right and left 31.2 in. (792 mm)

Drawbar Welded box section, 3.5x7x0.5 in. (89x178x13 mm) wall w/ball and socket draft connection

Frame:
 Rear main frame... Welded box section from articulation joint to main frame arch
 Width, minimum 9.25 in. (235 mm)
 Height, minimum 14.65 in. (372 mm)
 Thickness, sides 0.63 in. (16 mm)
 top and bottom (min.)... 0.75 in. (19 mm)
 Weight per ft. (m), minimum 110 lb. (164 kg/m)
 Minimum vertical section modulus... 125 inches cubed (2050 cm cubed)
 Front main frame... Welded box section from main frame arch to front hood
 Width 10 in. (254 mm)
 Height, minimum 13 in. (330 mm)
 Thickness, minimum 0.50 in. (13 mm)
 Weight per ft. (m), minimum 110 lb. (164 kg/m)
 Minimum vertical section modulus... 109 inches cubed (1786 cm cubed)

Capacities:	U.S.	Imp.	Liters
Fuel tank	60 gal.	50.0 gal.	227
Cooling system	7 gal.	5.8 gal.	26.5
Engine lubrication, including filter	20 qt.	16.7 qt.	18.9
Transmission case	14 gal.	12 gal.	53
Transmission and hydraulic system (JD670-A)	28 gal.	23.3 gal.	106
Transmission and hydraulic system (JD672-A)	38 gal.	32 gal.	144
Tandem housings (each)	4 gal.	3.3 gal.	15.1
Worm gearbox	3 qt.	2.5 qt.	2.8

Additional Standard Equipment:

Transistorized voltage regulator	Gauges:
Lights (2 white front w/stop and tail light)	Water temperature
Work lights (2 front and 2 rear floods)	Transmission temperature
Turn signals	Transmission lube pressure
Horn	Transmission pressure
Deluxe suspension seat	Engine oil pressure
Mechanical hour meter	Fuel
Cold weather starting aid	Indicators:
Precleaner	All-wheel drive charge pressure (JD672-A)
Engine side shields	Air filter
ROPS cab w/seat belt	Transmission filter
Front and rear windshield wipers	All-wheel drive filter (JD672-A)
Floor mat	

Dimensions:

Tire Size	Wheel Tread		Width		Ground Clearance (Front Axle)
	Front	Rear	Front	Rear	
13.00-24	76.60 in. (1.94 m)	79.61 in. (2.02 m)	7 ft. 10 in. (2.34 m)	7 ft. 10 in. (2.34 m)	1 ft. 10 in. (559 mm)
14.00-24	76.60 in. (1.94 m)	79.61 in. (2.02 m)	8 ft. (2.44 m)	8 ft. (2.44 m)	1 ft. 10.5 in. (571 mm)
17.5-25	79.36 in. (2.01 m)	82.37 in. (2.09 m)	8 ft. 6 in. (2.59 m)	8 ft. 6 in. (2.59 m)	1 ft. 11.2 in. (589 mm)

Height to top of steering wheel... 7 ft. 4.4 in. (2.25 m)

Scarifier (Special Equipment):

V-type for 4 ft. (1.22 m) cut with 3 manual pitch positions and hydraulic float
 Number of teeth (9 possible) 5
 Lift above ground 1 ft. 10 in. (559 mm)
 Penetration 12 in. (305 mm)
 Shank size 1.25x4 in. (31.7x102 mm)

Ripper (Special Equipment): 8 ft. (2.44 m) cut width, parallelogram linkage, 2 manual shank vertical positions

Number of shank pockets 5
 Number of shanks 3
 Lift above ground 1 ft. 2.5 in. (368 mm)
 Penetration 1 ft. 2 in. (356 mm)
 Shank size 2x5 in. (51x127 mm)
 Lift above ground (shanks in upper position) 1 ft. 11.5 in. (597 mm)

JD670-A

SAE Operating Weight	On Front Wheels	On Rear Wheels	Total
Standard equipment	7728 lb. (3 505 kg)	18,252 lb. (8 279 kg)	25,980 lb. (11 784 kg)
Standard equipment and scarifier	8828 lb. (4 004 kg)	18,252 lb. (8 279 kg)	27,080 lb. (12 283 kg)
Standard equipment, scarifier and ripper	8031 lb. (3 643 kg)	21,549 lb. (9 775 kg)	29,580 lb. (13 418 kg)

JD672-A

SAE Operating Weight	On Front Wheels	On Rear Wheels	Total
Standard equipment	8568 lb. (3 886 kg)	18,507 lb. (8 395 kg)	27,075 lb. (12 281 kg)
Standard equipment and scarifier	9668 lb. (4 385 kg)	18,507 lb. (8 395 kg)	28,175 lb. (12 780 kg)
Standard equipment, scarifier and ripper	8871 lb. (4 024 kg)	21,804 lb. (9 890 kg)	30,675 lb. (13 914 kg)

Tires:

13.00-24, 8 or 12 ply rating; 8 in. rim
 14.00-24, 10 or 12 ply rating; 8 or 10 in. rim
 17.5-25, 12 ply rating; 14 in. rim

Special Equipment:

Scarifier	Overlay end bits
Heavy-duty scarifier	Transmission bottom guard
Below-cab blade lights	Heavy-duty bottom guard w/drawbar
Bench seat	Rear-mounted ripper w/drawbar hitch
Cab heater (40,000 BTU)	Drawbar hitch
Cab heater (19,000 BTU)	Toolbox
Cab defroster fan	Articulation indicator
Air conditioning w/50 amp heavy-duty alternator	Engine disconnect
Roof-mounted heater (w/air conditioner only)	Reverse warning system
Outside rear view mirrors	Sound-baffled engine side shields
ROPS canopy w/seat belt	3 in. seat belt
Coolant heater	Heavy-duty cutting edge
2 ft. (610 mm) moldboard extensions, right or left	Automatic blade control
13 ft. (3.96 m) and 14 ft. (4.27 m) moldboards	

DIMENSIONS

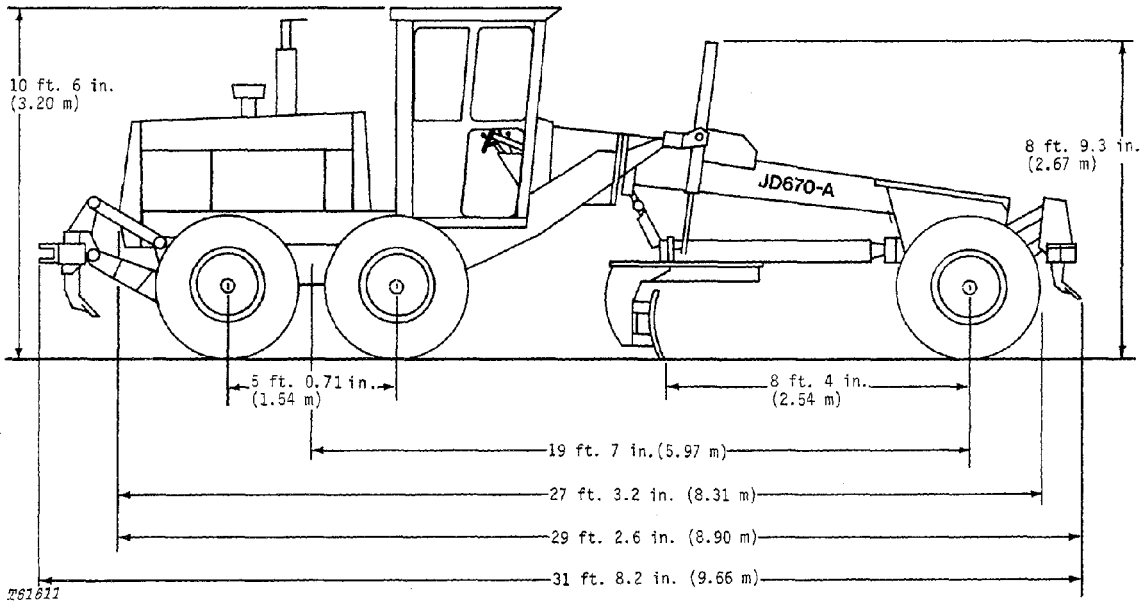

NOTE: Dimensions for the JD672-A are the same as those shown above. When a motor grader has air conditioning, the height is 10 ft. 7 in. (3.23 m).

Group IV PREDELIVERY, DELIVERY, AND AFTER-SALE SERVICES

TEMPORARY GRADER STORAGE

After receiving your grader from the factory and before putting the machine into temporary storage, perform the following checks.

1. Check the battery electrolyte level. Charge the battery, if necessary.
2. Check the level of the coolant in the radiator. The coolant must be 4 in. (102 mm) below the top of the filler neck.
3. Fill the fuel tank.
4. Check the crankcase oil level. Oil must be between marks on the dipstick after the engine has been stopped for 10 minutes.
5. Relieve hydraulic pressure by lowering the blade, stopping the engine and operating the hydraulic control levers until no equipment moves.

PREDELIVERY SERVICE

The service technician must carefully check and service the machine before the dealer delivers it to the customer. When the customer receives a machine that is correctly prepared, the customer is well-satisfied. For these reasons, correct predelivery service is very important to the dealer and the customer.

Use the following check list when getting a unit ready for delivery to the customer.

1. Cab Equipment

Check the operation of doors, windows, seat belts, horn, defroster fan, dome light, wipers, heater, etc.

Check air conditioner controls.

NOTE: Air temperature must be 60°F (16°C) or higher.

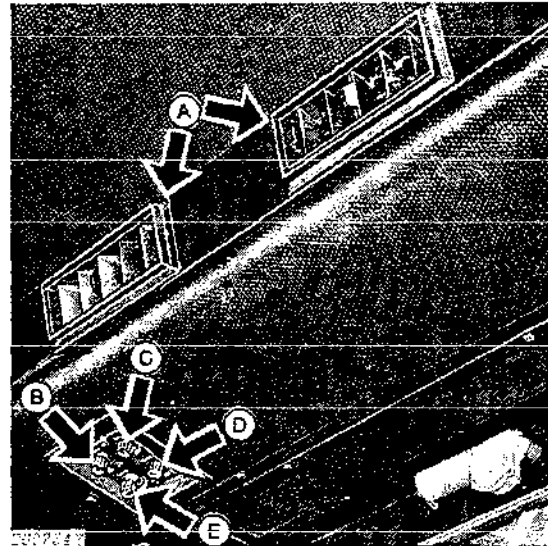

A—Louvers
B—Recirculating Air Control
C—Heat Control Knob
D—Cooling Control Knob
E—Blower Control Knob

Fig. 1—Air Conditioner Controls

1 - Turn key switch ON. Operate the blower control knob (E) in all positions. Check the fan speeds and air volume from the louvers (A).

2 - Turn the key and blower switches ON. Turn the cooling control knob (D) clockwise toward maximum cooling. Listen for the click from the compressor clutch.

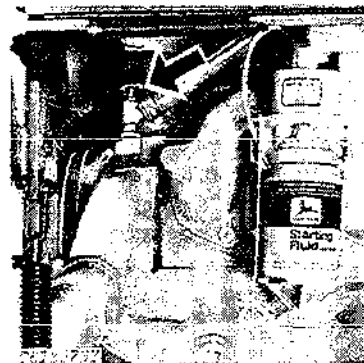

Fig. 2—Heater Valve

3 - Turn the heater valve (Fig. 2) clockwise to closed position.

4 - Turn the blower control knob clockwise to high speed. Turn the cooling control knob clockwise to maximum cooling. Run the engine at approximately 2000 rpm.

5 - After ten minutes check sight glass for bubbles. The sight glass is on the receiver-dryer in the engine compartment next to the compressor.

NOTE: Bubbles may be seen immediately after the compressor cycles ON. If bubbles are seen under any other condition, see Section 90, Group 9031.

6 - Check the temperature of air from louvers. Hold a thermometer in louver until you get the lowest reading.

When air temperature is above 80°F (27°C), the temperature of air from louvers must be 25°-30°F (14°-17°C) lower.

When air temperature is below 80°F (27°C), the temperature of air from louvers must be less than 50°F (10°C).

7 - When the unit does not operate correctly, see Section 90, Group 9031.

Cab equipment checked Yes No

2. Seat

Check operation of seat controls.

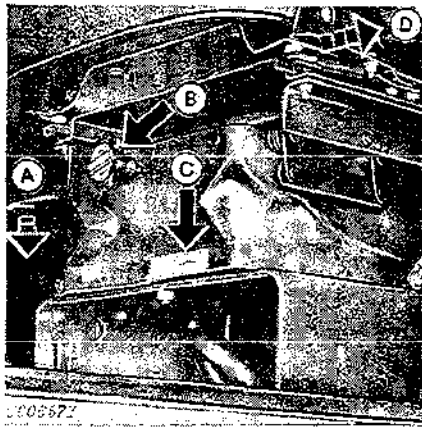

Fig. 3-Controls for Cab Seat and Seat without Cab

A - Height adjustment lever - Push down the lever. Move the seat to the desired position. Release the lever.

B - Weight adjustment knob - Turn the knob clockwise for a firm ride. Turn the knob counterclockwise for a soft ride. Use the flip-out handle to crank the knob.

C - Weight adjustment tube - Sit on the seat. Turn knob B until the yellow pointer inside the tube is flush with tube.

D - Forward and rearward adjustment lever - Move the lever outward to the left (L.H.). Move the seat forward or rearward to the desired position. Release the lever.

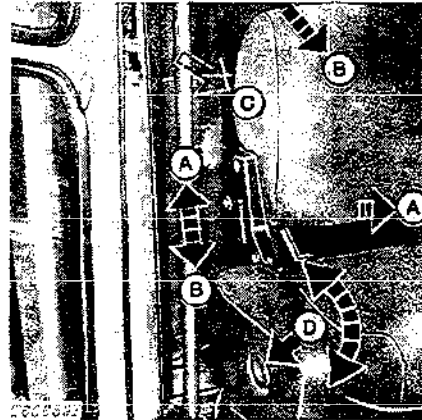

Fig. 4 - Cab Seat Controls

A - Backrest tilt knob - Lift the knob to tilt the bottom of the backrest forward.

B - Lower the knob to tilt the top of the backrest forward.

C - Backrest knob - Raise the knob for a soft backrest. Lower the knob for a firm backrest.

D - Armrest button - Hold the button in. Move the armrest up or down to the desired position. Release the button. The armrest will latch in four different positions.

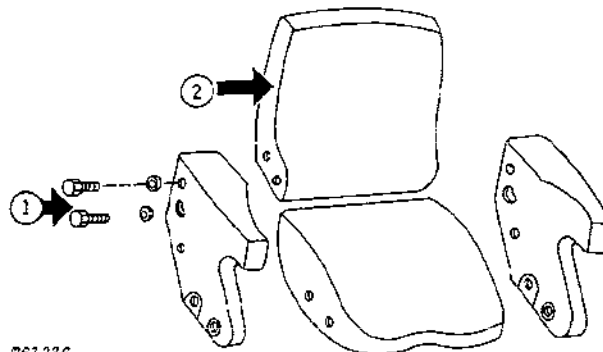
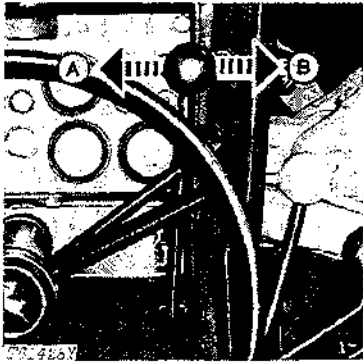

Fig. 5-Adjustment for Seat without Cab

Adjust backrest tilt as follows:

- 1 - Loosen two cap screws on each side.
- 2 - Move the backrest to the desired position.
- 3 - Tighten the cap screws.

Seat controls checked Yes No



A—Wheel Lean Left (L.H.) B—Wheel Lean Right (R.H.)

Fig. 10-Wheel Lean Lever

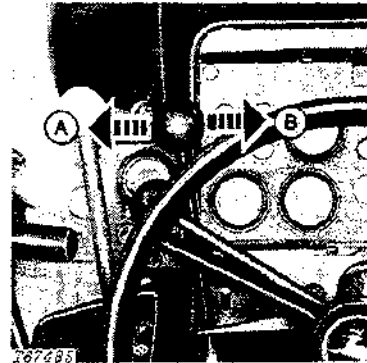

A—Circle Side-Shift Left (L.H.) B—Circle Side-Shift Right (R.H.)

Fig. 12-Circle Side-Shift Lever

Lean wheels toward turn to make a sharper turn.

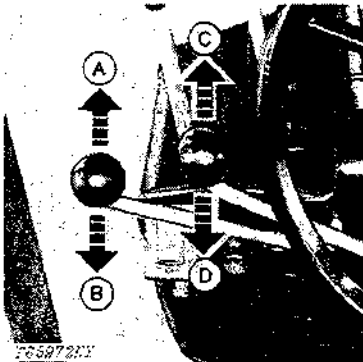

A—Lower Scarifier C—Pitch Blade Forward
B—Raise Scarifier D—Pitch Blade Rearward

Fig. 11-Scarifier Lever and Blade Pitch Lever

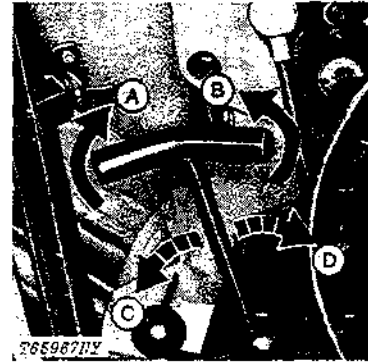

A—Rotate Circle Clockwise C—Blade Side-Shift Left (L.H.)
B—Rotate Circle Counterclockwise D—Blade Side-Shift Right (R.H.)

Fig. 13-Circle Rotation Lever and Blade Side-Shift Lever

Scarifier Lever: Push the lever forward until it locks in float position. Pull the lever back to release it from float.

IMPORTANT: Be sure blade does not contact tires or main frame during rotation.

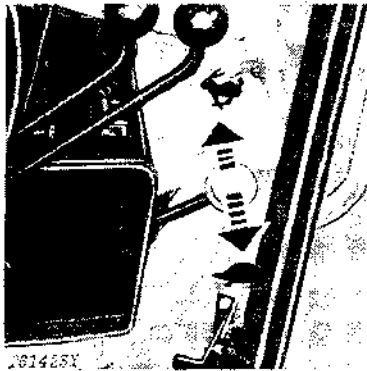

Fig. 14-Hand Throttle

Use the hand throttle to operate at constant speed.

Control levers checked Yes No

5. Control Pedals

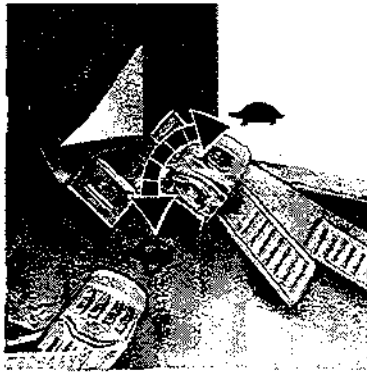

Fig. 15-Accelerator Pedal

Push down the pedal to increase speed quickly. When you release the pedal, speed will go back to the hand throttle setting.

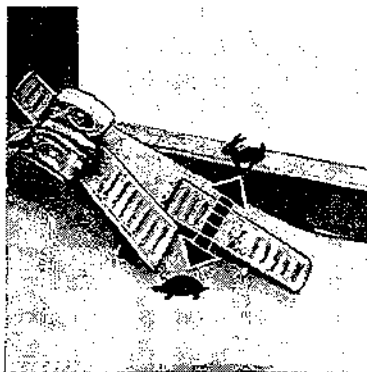
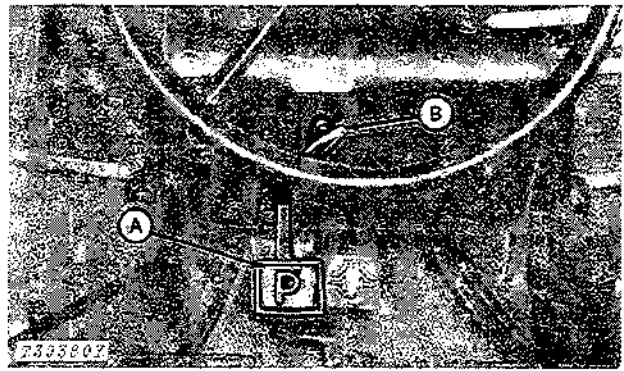

Fig. 16-Decelerator

Push down the pedal to decrease speed quickly. When you release the pedal, speed will go back to the hand throttle setting.

Litho in U.S.A.



A—Engage Pedal

B—Disengage Handle

Fig. 17-Parking Brake

Push down the parking brake. When the pedal uses over 3/4 total travel to fully engage the brake, change the adjustment. See page I-IV-26.

To release the parking brake, pull handle B, while holding down pedal A to take the load off the latch.

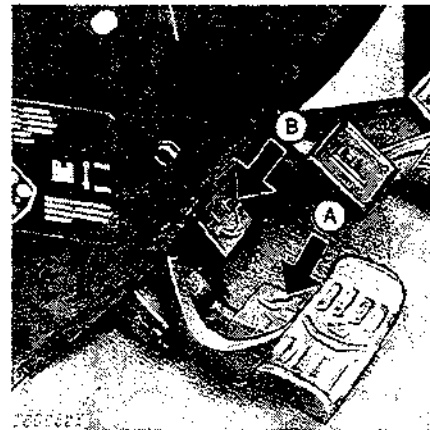

A—Differential Engage Pedal

B—Differential Disengage Pedal

Fig. 18-Differential Lock Pedals

Check the operation of the differential lock. Engage the lock and attempt to turn the steering wheel. If the lock is working correctly, steering resistance must be felt.