

Technical Manual

John Deere JD401-C Loader and Backhoe Loader

TM1092



Litho in U.S.A.

JD401-C LOADER AND BACKHOE LOADER

Technical Manual
TM-1092 (Jan-79)

CONTENTS

Section 10 - GENERAL

- Group 5 Specifications
- Group 10 Predelivery, Delivery, and After-Sale Services
- Group 15 Lubrication

Section 20 - ENGINE

- Group 5 Engine Removal and Installation
- Group 10 Basic Engine
- Group 15 Engine Lubrication System
- Group 20 Engine Cooling System
- Group 25 Fuel System
- Group 30 Speed Control Linkage
- Group 35 Air Intake System
- Group 40 Specifications and Special Tools

Section 30 - ELECTRICAL SYSTEM

- Group 5 Batteries
- Group 10 Charging System
- Group 15 Starting System
- Group 20 Ignition System
- Group 25 Gauges and Switches
- Group 30 Specifications and Special Tools

Section 40 - POWER TRAIN

- Group 5 Clutch Assemblies
- Group 10 Transmission
- Group 15 Reverser
- Group 20 Continuous Running PTO
- Group 25 Differential and Parking Brake
- Group 30 Final Drives
- Group 35 Specifications and Special Tools

Section 50 - HYDRAULIC SYSTEM

- Group 5 Transmission Pump
- Group 10 Main Hydraulic Pump
- Group 15 Reverser Clutch Control Valve
- Group 20 Pressure Control Valve
- Group 25 Steering Valve
- Group 30 Brake Valve
- Group 35 Loader Control Valve
- Group 40 Backhoe Control Valve
- Group 45 Selective Control Valve
- Group 50 Rockshaft System
- Group 55 Miscellaneous Hydraulic Components
- Group 60 Hydraulic Cylinders
- Group 61 Remote Cylinder
- Group 62 9250 Backhoe Cylinders
- Group 63 9250-A Backhoe Cylinders
- Group 65 Specifications and Special Tools

Section 60 - MISCELLANEOUS COMPONENTS

- Group 5 Front End Assembly
- Group 10 Loader Frame, Boom and Bucket
- Group 15 Backhoe Frame, Boom, Dipperstick and Bucket
- Group 16 9250-A Backhoe Frame, Boom, Dipperstick and Bucket
- Group 20 Three-Point Hitch
- Group 25 Specifications and Special Tools

Section 70 - SYSTEM TESTING

- Group 5 General Information
- Group 10 Engine
- Group 15 Electrical System
- Group 20 Power Train
- Group 25 Hydraulic System
- Group 26 Hydraulic System (Analyzer)
- Group 30 Miscellaneous Components
- Group 35 Specifications and Special Tools

Section 80 - INDEX

The specifications and design information contained in this manual were correct at the time this machine was manufactured. It is John Deere's policy to continually improve and update our machines. Therefore, the specifications and design information are subject to change without notice. Wherever applicable, specifications and design information are in accordance with SAE and ICED standards.

Copyright 1973
DEERE & COMPANY
Moline, Illinois
All rights reserved

INTRODUCTION

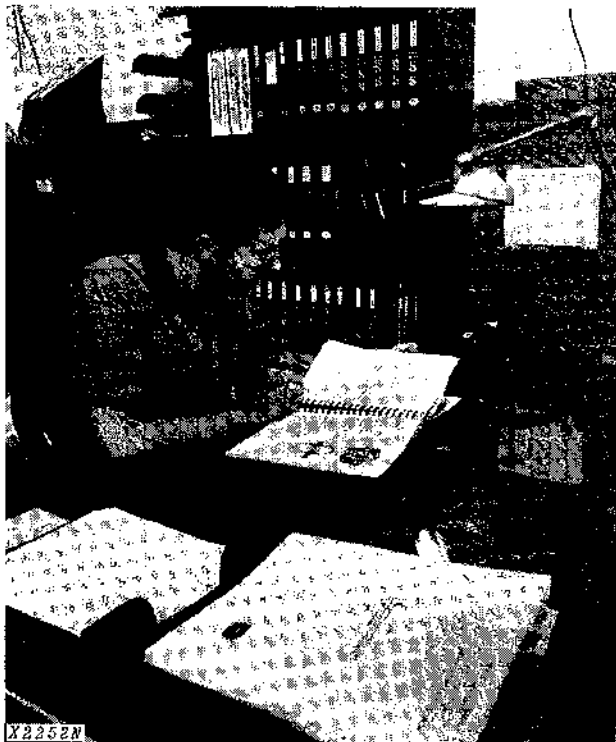

Use FOS Manuals for Reference



Use Technical Manuals for Actual Service

This technical manual is part of a twin concept of service:

The two kinds of manuals work as a team to give you both the general background and technical details of shop service.

•FOS Manuals—for reference

Fundamentals of Service (FOS) Manuals cover basic theory of operation, *fundamentals* of trouble shooting, *general* maintenance, and *basic* types of failure and their causes. FOS Manuals are for training new personnel and for reference by experienced service technicians.



When a service technician should refer to a FOS Manual for more information, a FOS symbol like the one at the left is used in the TM to identify the reference.

•Technical Manuals—for actual service

Technical Manuals are concise service guides for a specific machine. Technical manuals are on-the-job guides containing only the vital information needed by an experienced service technician.

This technical manual was planned and written for you—an experienced service technician. Keep it in a permanent binder in the shop where it is handy. Refer to it whenever in doubt about correct service procedures or specifications.

Some features of this manual:

- Inside front cover - "Table of Contents" and "Maintenance Without Accident".
- Section 10 - General specifications and services.
- Sections 20 through 60 - Removal, repair, testing (components removed), installation, and adjustment.
- Section 70 - Detailed explanation of system operation, diagnosis, visual inspection, testing, and adjustments.
- Specifications grouped and illustrated at the end of each section.

**Thanks very much for your reading,
Want to get more information,
Please click here, Then get the complete
manual**

JustClickHere 

NOTE:

**If there is no response to click on the link above,
please download the PDF document first, and then
click on it.**

**Have any questions please write to me:
admin@servicemanualperfect.com**

MAINTENANCE WITHOUT ACCIDENT WORK SAFELY



T27999

 This safety alert symbol identifies important safety messages in this manual and on the loader and loader backhoe. When you see this symbol, be alert to the possibility of personal injury and carefully read the message that follows.

**EVERY EMPLOYER HAS A
SAFETY PROGRAM. KNOW
WHAT IT IS!**

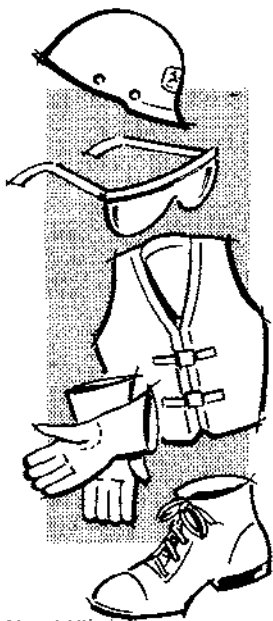

T27501N

Consult your shop foreman for specific instructions on a job, and the safety equipment required.

For instance, you may need: Hard hat, safety shoes, safety goggles, heavy gloves, reflector vests, ear protectors, respirators.

RIGHT



WRONG

T27502N

BE ALERT!

Plan ahead — work safely — know how to use a first-aid kit and a fire extinguisher — and where to get aid and assistance.

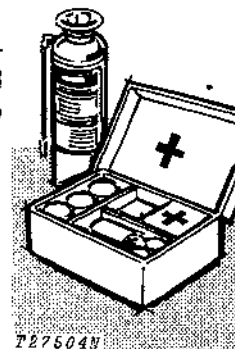

T27504N

Maintenance Area

Make sure the maintenance area is adequately vented.

Keep maintenance area **CLEAN AND DRY**. Oily and wet floors are slippery; greasy rags are a fire hazard; wet spots are dangerous when working with electrical equipment.

Store starting aids in a cool and well-ventilated place, out of the reach of unauthorized personnel.

MAINTENANCE WITHOUT ACCIDENT

AVOID FIRE HAZARDS—

Fuel Is Dangerous!

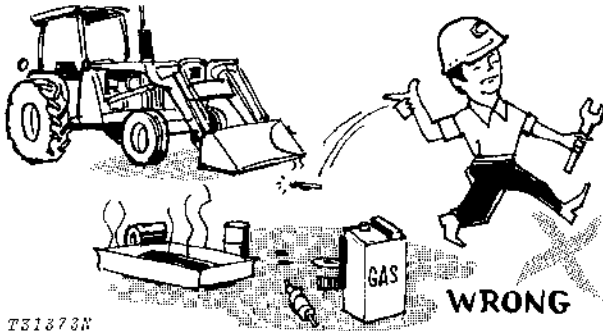

T31373N

Don't smoke while refueling.

Don't smoke while handling highly flammable material.

Engine should be shut off when refueling.

Use care in refueling if the engine is hot.

Don't use open pans of gasoline or diesel fuel for cleaning parts. Good commercial, nonflammable solvents are preferred.

Battery Gas Is Highly Flammable!

Provide adequate ventilation when charging batteries.



T27506N

Don't check battery charge by placing metal objects across the posts.

Don't allow sparks or open flame near batteries.

Don't smoke near battery.

Flame Is Not a Flashlight!

NEVER USE OPEN FLAME AROUND THE MACHINE.

KNOW WHERE FIRE EXTINGUISHERS ARE KEPT!

UNDER ALL MAINTENANCE CONDITIONS—

Do not perform any work on the equipment unless authorized to do so. Then be sure you know the safe and proper procedure.

Follow recommended procedures.

Never service the equipment while it is being operated.

Avoid working on equipment with the engine running.

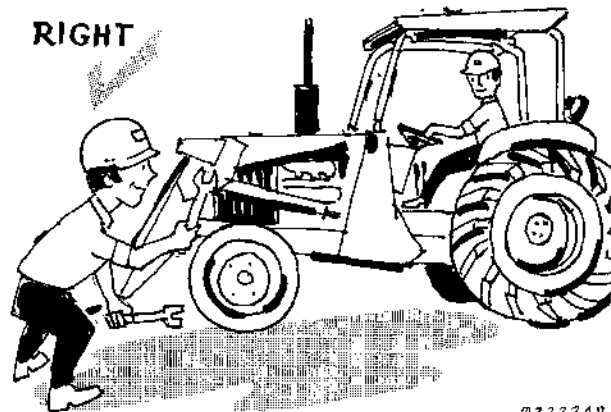

T31374N

If it is necessary to make checks with the engine running, **ALWAYS USE TWO** service technicians—one, the operator, at the controls, the other checking within sight of the operator.

KEEP HANDS AWAY FROM MOVING PARTS

Support all raised equipment.

Never work under raised bucket or backhoe.

Lower bucket and backhoe to ground.

If the machine is on an incline, block it securely.

Use hoisting equipment for lifting heavy parts.

TAKE CARE! WATCH OUT FOR OTHER PEOPLE IN THE VICINITY

Wear safety glasses when drilling, grinding, or hammering metal.

SERVICING PRECAUTIONS

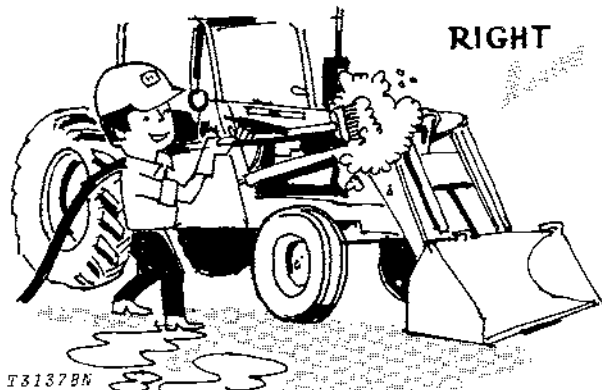

Keep ALL equipment free of dirt and oil.

Be sure to clean any oil, grease, mud, ice, or snow from floor of operator's compartment and stepping points.

When preparing the engine for storage, remember that inhibitor is volatile and therefore dangerous. Seal and tape openings after adding the inhibitor. Keep container tightly closed when not in use.

Don't remove the radiator cap until coolant temperature is below the boiling point. Then loosen cap slowly to the stop to relieve pressure before removing.

Periodically check exhaust system for excessive leakage.

Relieve hydraulic pressure before working on hydraulic system: shut off engine, lower bucket and backhoe to ground, and move control levers and steering wheel until no response is felt.

When checking hydraulic pressure, be sure to use the correct test gauge.

PRECAUTIONS DURING REPAIR

Before working on hydraulic system relieve hydraulic pressure.

Before repairing the electrical system, or performing a major overhaul, disconnect batteries.

KNOW EQUIPMENT IS READY!

Check guards, canopies, safety guards — all protective devices installed on the unit. Every one should be in place and secure.

CHECK IT OUT!

- GUARDS
- CANOPIES
- SHIELDS
- PROTECTIVE DEVICES
- ROLL-OVER PROTECTIVE STRUCTURES
- SEAT BELTS, ETC.

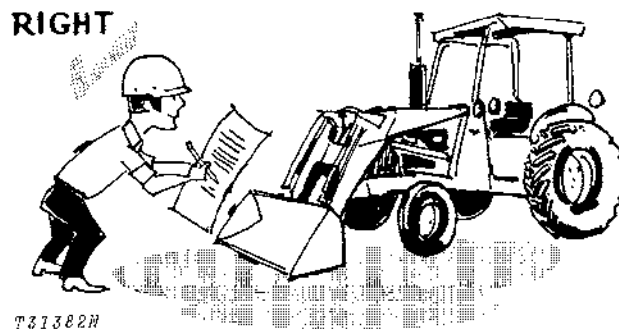

Carefully inspect equipment for visual defects—leaks in fuel, lubrication, and hydraulic systems. Do not search for pressurized fluid leaks with your hands. Use cardboard or wood to search for leaks.

**COMPLETE PAGE LISTING
 WITH LATEST DATE LINES**

1,2	(Jan-79)	20-25-13,14	(Jan-79)	40-5-9,10	(Jan-79)
3,4	(Jan-79)	20-30-1,2	(Jan-79)	40-5-11,12	(Oct-79)
5,6	(Jan-79)	20-35-1,2	(Oct-79)	40-5-13,14	(Jan-79)
7,8	(Oct-79)	20-40-1,2	(Oct-79)	40-10-1,2	(Jan-79)
		20-40-3,4	(Oct-79)	40-10-3,4	(Jan-79)
10-5-1,2	(Oct-79)	20-40-5,6	(Oct-79)	40-10-5,6	(Jan-79)
10-5-3,4	(Oct-79)	20-40-7,8	(Oct-79)	40-10-7,8	(Jan-79)
10-10-1,2	(Oct-79)	20-40-9,10	(Oct-79)	40-10-9,10	(Jan-79)
10-10-3,4	(Oct-79)	20-40-11,12	(Oct-79)	40-15-1,2	(Jan-79)
10-10-5,6	(Oct-79)	20-40-13,14	(Oct-79)	40-15-3,4	(Jan-79)
10-10-7,8	(Oct-79)	20-40-15,16	(Oct-79)	40-15-5,6	(Jan-79)
10-10-9,10	(Oct-79)	20-40-17,18	(Oct-79)	40-20-1,2	(Jan-79)
10-10-11,12	(Oct-79)	20-40-19,20	(Oct-79)	40-20-3,4	(Jan-79)
10-10-13,14	(Oct-79)	20-40-21,22	(Jan-79)	40-25-1,2	(Jan-79)
10-10-15,16	(Oct-79)	20-40-23,24	(Jan-79)	40-25-3,4	(Jan-79)
10-10-17,18	(Oct-79)	20-40-25,26	(Jan-79)	40-25-5,6	(Jan-79)
10-10-19,20	(Oct-79)	20-40-27,28	(Jan-79)	40-30-1,2	(Jan-79)
10-10-21,22	(Oct-79)			40-30-3,4	(Jan-79)
10-10-23,24	(Oct-79)	30-5-1,2	(Jan-79)	40-30-5,6	(Jan-79)
10-10-25,26	(Oct-79)	30-5-3,4	(Jan-79)	40-35-1,2	(Oct-79)
10-10-27,28	(Oct-79)	30-5-5,6	(Jan-79)	40-35-3,4	(Jan-79)
10-10-29,30	(Oct-79)	30-10-1,2	(Jan-79)	40-35-5,6	(Jan-79)
10-10-31,32	(Oct-79)	30-10-3,4	(Jan-79)	40-35-7,8	(Jan-79)
10-10-33,34*	(Jan-79)	30-10-5,6	(Jan-79)		
10-10-35,36*	(Jan-79)	30-10-7,8	(Jan-79)	50-5-1,2	(Jan-79)
10-15-1,2	(Jan-79)	30-10-9,10	(Jan-79)	50-5-3,4	(Jan-79)
		30-10-11,12	(Jan-79)	50-10-1,2	(Jan-79)
20-5-1,2	(Jan-79)	30-15-1,2	(Jan-79)	50-10-3,4	(Oct-79)
20-5-3,4	(Oct-79)	30-15-3,4	(Jan-79)	50-10-5,6	(Oct-79)
20-10-1,2	(Oct-79)	30-15-5,6	(Jan-79)	50-15-1,2	(Oct-79)
20-10-3,4	(Jan-79)	30-15-7,8	(Jan-79)	50-15-3,4	(Jan-79)
20-10-5,6	(Oct-79)	30-15-9,10	(Jan-79)	50-15-5,6	(Jan-79)
20-10-7,8	(Jan-79)	30-20-1,2	(Jan-79)	50-20-1,2	(Oct-79)
20-10-9,10	(Oct-79)	30-20-3,4	(Jan-79)	50-25-1,2	(Oct-79)
20-10-11,12	(Oct-79)	30-20-5,6	(Jan-79)	50-25-3,4	(Oct-79)
20-10-13,14	(Jan-79)	30-20-7,8	(Jan-79)	50-25-5,6	(Jan-79)
20-10-15,16	(Jan-79)	30-25-1,2	(Jan-79)	50-25-7,8	(Jan-79)
20-10-17,18	(Oct-79)	30-25-3,4	(Jan-79)	50-30-1,2	(Oct-79)
20-10-19,20	(Jan-79)	30-30-1,2	(Jan-79)	50-30-3,4	(Oct-79)
20-10-21,22	(Jan-79)	30-30-3,4	(Jan-79)	50-35-1,2	(Jan-79)
20-15-1,2	(Oct-79)	30-30-5,6	(Jan-79)	50-35-3,4	(Jan-79)
20-15-3,4	(Jan-79)	30-30-7,8	(Jan-79)	50-35-5,6	(Jan-79)
20-20-1,2	(Jan-79)	30-30-9,10	(Jan-79)	50-35-7,8	(Jan-79)
20-20-3,4	(Jan-79)	30-30-11,12	(Jan-79)	50-35-9,10	(Jan-79)
20-25-1,2	(Jan-79)	30-30-13,14	(Jan-79)	50-35-11,12	(Jan-79)
20-25-3,4	(Jan-79)			50-35-13,14	(Jan-79)
20-25-5,6	(Jan-79)	40-5-1,2	(Jan-79)	50-40-1,2	(Jan-79)
20-25-7,8	(Jan-79)	40-5-3,4	(Jan-79)	50-40-3,4	(Jan-79)
20-25-9,10	(Jan-79)	40-5-5,6	(Jan-79)	50-40-5,6	(Jan-79)
20-25-11,12	(Jan-79)	40-5-7,8	(Jan-79)	50-41-1,2	(Jan-79)
				50-41-3,4	(Jan-79)

Vertical lines indicate pages included in this revision.

*Remove these pages from the manual.

Litho in U.S.A.

PAGE LISTING—Continued

50-41-5,6	(Jan-79)	60-10-3,4	(Jan-79)	70-25-1,2	(Oct-79)
50-45-1,2	(Jan-79)	60-10-5,6	(Jan-79)	70-25-3,4	(Jan-79)
50-45-3,4	(Jan-79)	60-15-1,2	(Jan-79)	70-25-5,6	(Jan-79)
50-45-5,6	(Jan-79)	60-15-3,4	(Jan-79)	70-25-7,8	(Jan-79)
50-45-7,8	(Jan-79)	60-15-5,6	(Jan-79)	70-25-9,10	(Jan-79)
50-50-1,2	(Jan-79)	60-15-7,8	(Jan-79)	70-25-11,12	(Oct-79)
50-50-3,4	(Jan-79)	60-16-1,2	(Jan-79)	70-25-13,14	(Jan-79)
50-50-5,6	(Oct-79)	60-16-3,4	(Jan-79)	70-25-15,16	(Jan-79)
50-50-7,8	(Jan-79)	60-16-5,6	(Jan-79)	70-25-17,18	(Jan-79)
50-50-9,10	(Jan-79)	60-16-7,8	(Jan-79)	70-26-1,2	(Jan-79)
50-50-11,12	(Oct-79)	60-16-9,10	(Jan-79)	70-26-3,4	(Jan-79)
50-50-13,14	(Jan-79)	60-20-1,2	(Jan-79)	70-26-5,6	(Jan-79)
50-55-1,2	(Jan-79)	60-25-1,2	(Jan-79)	70-26-7,8	(Jan-79)
50-55-3,4	(Oct-79)	60-25-3,4	(Jan-79)	70-26-9,10	(Jan-79)
50-55-5,6	(Jan-79)			70-26-11,12	(Oct-79)
50-55-7,8	(Oct-79)	70-5-1,2	(Jan-79)	70-26-13,14	(Jan-79)
50-55-9,10	(Oct-79)	70-10-1,2	(Jan-79)	70-26-15,16	(Jan-79)
50-60-1,2	(Jan-79)	70-10-3,4	(Jan-79)	70-26-17,18	(Jan-79)
50-60-3,4	(Jan-79)	70-10-5,6	(Jan-79)	70-26-19,20	(Jan-79)
50-61-1,2	(Jan-79)	70-10-7,8	(Jan-79)	70-26-21,22	(Jan-79)
50-62-1,2	(Jan-79)	70-10-9,10	(Jan-79)	70-26-23,24	(Jan-79)
50-62-3,4	(Jan-79)	70-10-11,12	(Jan-79)	70-26-25,26	(Jan-79)
50-62-5,6	(Jan-79)	70-10-13,14	(Jan-79)	70-26-27,28	(Jan-79)
50-62-7,8	(Jan-79)	70-10-15,16	(Oct-79)	70-30-1,2	(Oct-79)
60-63-1,2	(Jan-79)	70-15-1,2	(Jan-79)	70-35-1,2	(Oct-79)
50-63-3,4	(Jan-79)	70-15-3,4	(Jan-79)	70-35-3,4	(Jan-79)
50-63-5,6	(Jan-79)	70-15-5,6	(Jan-79)	70-35-5,6	(Oct-79)
50-63-7,8	(Jan-79)	70-15-7,8	(Jan-79)	70-35-7,8	(Jan-79)
50-65-1,2	(Jan-79)	70-15-9,10	(Jan-79)	70-35-9,10	(Jan-79)
50-65-3,4	(Jan-79)	70-15-11,12	(Oct-79)	70-35-11,12	(Oct-79)
50-65-5,6	(Oct-79)	70-15-13,14	(Oct-79)	70-35-13,14	(Oct-79)
50-65-7,8	(Jan-79)	70-15-15,16	(Jan-79)	70-35-15,16	(Oct-79)
50-65-9,10	(Jan-79)	70-15-17,18	(Jan-79)	70-35-17,18	(Oct-79)
50-65-11,12	(Jan-79)	70-15-19,20	(Jan-79)	70-35-19,20	(Oct-79)
50-65-13,14	(Jan-79)	70-15-21,22	(Jan-79)	70-35-21,22	(Oct-79)
50-65-15,16	(Jan-79)	70-15-23,24	(Jan-79)		
50-65-17,18	(Jan-79)	70-15-25,26	(Oct-79)	Index - 1,2	(Oct-79)
50-65-19,20	(Oct-79)	70-15-27,28	(Jan-79)	Index - 3,4	(Oct-79)
50-65-21,22	(Oct-79)	70-15-29,30	(Jan-79)	Index - 5,6*	(Jan-79)
50-65-23,24	(Oct-79)	70-15-31,32	(Jan-79)	Index - 7,8*	(Jan-79)
		70-20-1,2	(Jan-79)		
60-5-1,2	(Jan-79)	70-20-3,4	(Jan-79)		
60-5-3,4	(Jan-79)	70-20-5,6	(Jan-79)		
60-5-5,6	(Jan-79)	70-20-7,8	(Jan-79)		
60-5-7,8	(Jan-79)	70-20-9,10	(Jan-79)		
60-10-1,2	(Jan-79)	70-20-11,12	(Oct-79)		
		70-20-13,14	(Jan-79)		

Vertical lines indicate pages included in this revision.

*Remove these pages from the manual.

Section 10 GENERAL

CONTENTS OF THIS SECTION

	Page		Page
GROUP 5 - SPECIFICATIONS		GROUP 15 - LUBRICATION	
General Machine Specifications	5-1	Lubricants	15-1
GROUP 10 - PREDELIVERY, DELIVERY, AND AFTER-SALE SERVICES			
Temporary Machine Storage	10-1		
Predelivery Service	10-1		
Delivery Service	10-14		
After-Sale Inspection	10-14		

Group 5 GENERAL MACHINE SPECIFICATIONS

(Specifications and design subject to change without notice. Wherever applicable specifications are in accordance with ICED and SAE Standards. Except where otherwise noted, these specifications are based on a unit equipped with 16.9-24, 6 ply rating, R4 rear tires; 11L-15, 8 ply rating, F-3 front tires; 3/4 cu. yd. (0.57 m³) bucket, and standard equipment.)

Power (@ 2500 engine rpm):	SAE	DIN
Gross	66 hp (49.2 kW*)	
Net	62 hp (46.2 kW)	65.9 PS

Net engine flywheel power is for an engine equipped with fan, air cleaner, water pump, lubricating oil pump, fuel pump, alternator, and muffler. Gross engine power is without fan. Flywheel power ratings are under SAE standard conditions of 500 ft. altitude and 85°F. temperature and DIN 70 020 standard conditions of 760 mm Hg barometer (sea level) and 20°C. temperature.

*In the International System of Units (SI), power is expressed in kilowatts (kW).

Engine: John Deere 4-cylinder diesel, valve-in-head, 4-stroke cycle

Bore and stroke	4.02x4.33 in. (102x110 mm)
Piston displacement	219 cu. in. (3 588 cm ³)
Compression ratio	16.2 to 1
Maximum torque @ 1300 rpm	160 lb-ft (217 Nm) (17.8 kg-m)

NACC or AMA (U.S. Tax) horsepower	25.65
Main bearings	5
Lubrication	Pressure system with full flow filter
Cooling	Pressurized with thermostat and fixed bypass

Fan	Suction
Air cleaner	Dry
Electrical system	12 volt with alternator
Batteries (two 12 volt)	Reserve capacity: 220 minutes

Engine Clutch Foot-operated, single 10 in. (254 mm) plate

Transmission:
 Constant mesh, 8 speeds forward, 8 reverse. Hydraulic direction reverser permits no-clutch reversing in all gears.

Gear:	Travel Speeds			
	mph		km/h	
	Fwd.	Rev.	Fwd.	Rev.
1	1.4	1.6	2.3	2.6
2	2.0	2.3	3.2	3.7
3	3.0	3.5	4.8	5.6
4	4.2	4.8	6.8	7.7
5	5.5	6.3	8.9	10.1
6	7.9	9.0	12.7	14.5
7	11.7	13.5	18.8	21.7
8	16.4	18.7	26.4	30.1

Final Drives Inboard, planetary

Hydraulic System: Closed-center	
Max. pressure	2350 psi (16 203 kPa) (165.2 kg/cm ²)
Loader control	Single-lever
Pump	Piston, constant pressure, variable displacement, 28 gpm (106 L/min) at 2500 engine rpm
Filter	25 micron steel-enclosed paper cartridge in return

Hydraulic

Cylinders:	Bore	Stroke
Boom	2.75 in. (70 mm)	28.25 in. (718 mm)
Bucket	2.5 in. (64 mm)	15.125 in. (384 mm)
Cylinder rods	Ground, heat-treated, chrome-plated, polished	
Boom cylinder rods	1.75-in. (44 mm) dia.	
Bucket cylinder rods	1.25-in. (32 mm) dia.	

Brakes . . . Hydraulically actuated, fully enclosed wet-disk. Self-equalizing. Foot-operated individually or simultaneously.

Steering Power
Turning radius
(brake applied) 11 ft. 1 in. (3.35 m)
Loader clearance
(brake applied) 33 ft. (10.06 m)
Number of turns, far left to far right 3.3

Tires:	Front	Rear
11L-15, 8 ply rating, F3		16.9-24, 6 ply rating, R1
7.50/8.00-16, 10 ply rating, F3		16.9-24, 8 ply rating, R4
		19.5L-24, 8 ply rating, R4

Wheel Treads:

Front 56 in. (1.42 m)
Rear 62 in. (1.57 m)

Dimensions:

Height to top of hood 4 ft. 7.3 in. (1.40 m)
Overall height to top of canopy 7 ft. 8 in. (2.34 m)
Overall width without bucket 6 ft. 7 in. (2.01 m)
Overall length
with 3-point hitch 14 ft. 9.25 in. (4.50 m)
Ground clearance (under
front axle) 1 ft. 6 in. (457 mm)
Ground clearance, min. 1 ft. 1.25 in. (337 mm)

Capacities

	U.S.	Liters
Cooling system	3 gal.	11.4
Fuel tank	19.5 gal.	73.8
Engine lubrication, including filter	9 qt.	8.5
Transmission and hydraulic system	10 gal.	37.9
Loader hydraulic system	3 gal.	11.4

Additional Standard Equipment:

- Transistorized voltage regulator
- Oil pressure indicator light
- Alternator charge indicator light
- Coolant temperature gauge
- Key switch safety start
- Cushioned seat
- Vertical muffler w/rain cap
- Fenders
- Antifreeze
- Bucket-level indicator
- Lights
- Differential lock
- Foot throttle
- Fuel gauge
- Air cleaner restriction indicator
- Cigar lighter
- Cold weather starting aid
- Speed-hour meter
- Horn

SAE Operating Weight 7840 lb. (3 556 kg)

DIMENSIONS

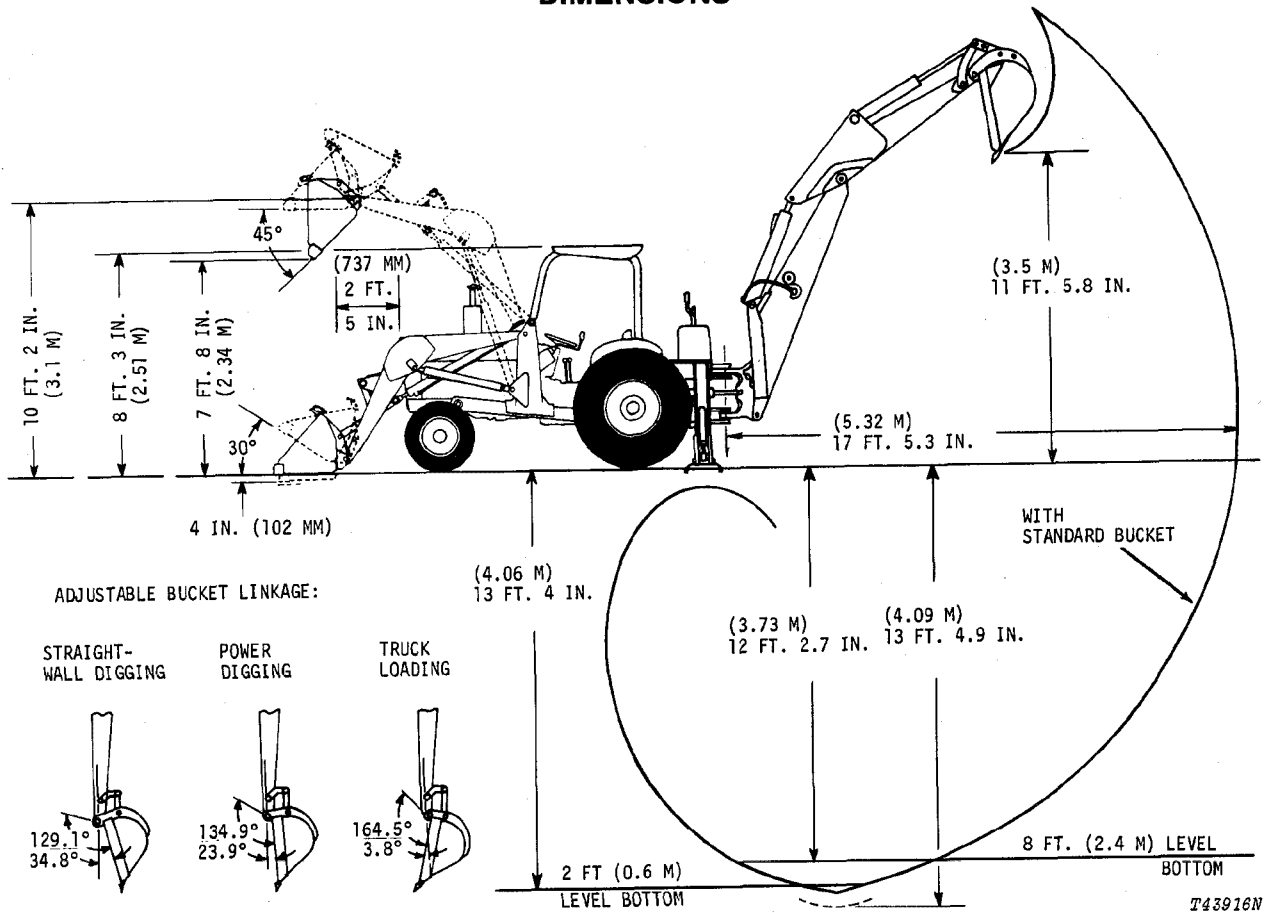

Special Equipment

- Backhoe
- Counterweights with bracket (without 3-point hitch or remote cylinder)
- Deluxe seat
- Front axle counterweights
- Front grille guard
- Parking brake
- Rear PTO (continuous "live" 540 rpm)
- Rear wheel weights
- Remote hydraulic cylinder
- ROPS with canopy and seat belt
- Single remote hydraulic cylinder control with quick-disconnect couplers
- Swinging drawbar
- 3 inch seat belt
- 3-point hitch (Category 1 or 2 with sway blocks and regular or short links)

Buckets:	Nominal Heaped Capacity	Width
	3/4 cu. yd. (0.57 m ³)	81.125 in. (2.06 m)
	1 cu. yd. (0.76 m ³)	81.125 in. (2.06 m)

Operating Information:

- Breakout force 5500 lb. (24.65 kN) (2 495 kg)
- Digging depth below ground level ... 4 in. (102 mm)
- Lifting capacity, full height 3500 lb. (1 590 kg)
- Maximum dumping angle 50 deg.
- Raising time to full height 3.5 sec.
- Bucket dumping time 1.3 sec.
- Lowering time (power) 2.3 sec.
- Float-down time 3.8 sec.
- Minimum effective rear wheel counterweight required, except when used with backhoe 2700 lb. (1 225 kg)

**9250-A WHEEL BACKHOE SPECIFICATIONS
(24 in. [610 mm] STANDARD BUCKET)**

Operating Information:

Digging depth (ICED):
 Maximum 13 ft. 5 in. (4.09 m)
 2 ft. (610 mm) flat bottom 13 ft. 4 in. (4.07 m)
 8 ft. (2.44 m) flat bottom 12 ft. 3 in. (3.73 m)
 Swing arc 180 deg.
 Digging force (bucket cylinder in power-dig
 position), ICED 7409 lb. (33.21 kN) (3 361 kg)
 Digging force, crowd
 cylinder 4198 lb. (18.82 kN) (1 904 kg)
 Reach from center of
 swing mast, ICED 17 ft. 5 in. (5.31 m)
 Reach from center of rear
 axle: 20 ft. 5.25 in. (6.23 m)
 Loading height, ICED 11 ft. 6 in. (3.51 m)
 Transport height 11 ft. 2 in. (3.40 m)

Hydraulic System: Closed-center

Max. Pressure 2350 psi (16 203 kPa)
 (165.2 kg/cm²)
 Pump 28 gpm (106 L/min)
 @ 2500 engine rpm

Hydraulic

Cylinders:	Bore	Stroke	Rod Diameter
Boom	4 in. (102 mm)	32.38 in. (822 mm)	2 in. (51 mm)
Crowd	3.5 in. (89 mm)	31.25 in. (794 mm)	1.75 in. (44 mm)
Bucket	3 in. (76 mm)	26.5 in. (673 mm)	1.75 in. (44 mm)
Swing	3.5 in. (89 mm)	8.88 in. (226 mm)	1.75 in. (44 mm)
Stabilizer	3.5 in. (89 mm)	15.5 in. (394 mm)	1.75 in. (44 mm)
Cylinder rods	Ground, heat-treated, chrome-plated, polished		

Stabilizer Width:

Transport position 6 ft. 8 in. (2.03 m)
 Operating position (overall) 9 ft. 8 in. (2.95 m)
 Operating position (ICED) 8 ft. 6 in. (2.59 m)

Buckets:

	Width		Struck Capacity	
	in.	mm	cu. ft.	m³
Standard	12	305	1.6	0.045
	16	406	2.6	0.074
	18	457	3.6	0.102
	24	610	4.8	0.136
	30	762	6.0	0.170
Heavy-duty	36	914	7.2	0.204
	18	457	3.6	0.102
Ejector	24	610	4.8	0.136
	24	610	4.2	0.119
Cemetery Special	36	914	7.2	0.204

Attachments:

Ripper tooth replaces backhoe bucket. Cast steel; 225 lb. (102 kg) tooth has hardened replaceable tip. Bolt-on rubber street pads for stabilizer pads.

Shipping Weight:

W/mounting parts,
 without bucket 2,550 lb. (1 157 kg)

Group 10 PREDELIVERY, DELIVERY, AND AFTER-SALE SERVICES

TEMPORARY UNIT STORAGE

After receiving your unit from the factory and before putting the machine into temporary storage, perform the following checks and services.

For long term storage (over 30 days) information, consult your JD401-C operator's manual.

1. Check battery electrolyte level and charge the battery, if necessary.
2. Check engine coolant level. Maintain midway between the radiator core and filler neck.
3. Fill the fuel tank.
4. Check crankcase oil level. Oil must be between marks on dipstick after machine has been shut down for 10 minutes.
5. Relieve hydraulic pressure by stopping engine, lowering bucket and backhoe and operating control levers and steering wheel until system fails to respond.
6. Reduce shipping pressure of all tires to the inflation pressure listed on page 10-10-2.

PREDELIVERY SERVICE

Because of the shipping factors involved, plus extra finishing touches that are necessary to promote customer satisfaction, proper predelivery service is of prime importance to the dealer and the customer.

Use the following list when preparing a unit for delivery to the customer.

1. Air Cleaner

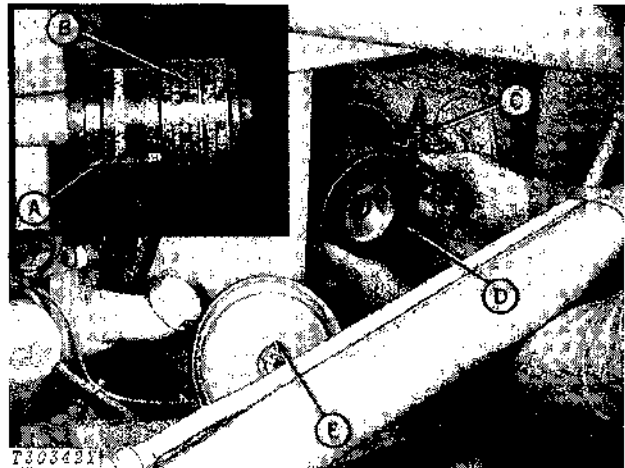

- A—Restriction Indicator D—Element
B—Red Signal E—Cover
C—Wing Nut

Fig. 1—Air Cleaner

Check air filter restriction indicator (A). If red signal can be fully seen, remove element (D) and clean. Install a new element if necessary.

Element checked	Yes	No
-----------------	-----	----

2. Radiator

Check engine coolant level.

CAUTION: Do not remove radiator filler cap unless the engine is cool. Then loosen the cap slowly to the stop to release pressure before removing the cap.

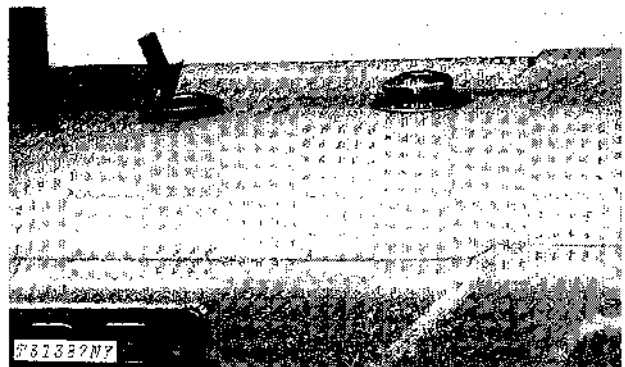

Fig. 2—Radiator Filler Cap

Maintain coolant level midway between the radiator core and the filler neck. If needed add clean soft water for warm weather or a solution of 50% clean water and 50% ethylene glycol (permanent type antifreeze with approved rust inhibitor) for cold weather. Tighten the filler cap.

Check cooling system for loose connections and leaks.

Coolant level checked Yes No

3. Batteries

Check battery electrolyte level. If distilled water is not available, use clean soft water. Avoid use of hard water. Remove foreign material from top of battery and coat terminals with petroleum jelly. Check vent holes in battery caps.

IMPORTANT: Never add water to battery in freezing weather unless engine will be run 2 or 3 hours.

Punch date code on battery.

Batteries checked Yes No

4. Tires

Check tire pressure with an accurate gauge having 1 psi (0.07 bar) graduation.

Inflate tires according to the chart below.

FRONT TIRES			
Tire Size	Type	Ply Rating	Inflation Pressure psi (bar)
11L-15	I-1A	8	40 (2.8)
7.50/8.00-16	F-3	10	56 (4)

REAR TIRES

Tire Size	Type	Ply Rating	Inflation Pressure psi (bar)
16.9-24	R1	6	16 (1.1)
16.9-24	R4	8	22 (1.5)
19.5L-24	R4	6	20 (1.4)

Tire pressure checked Yes No

5. Crankcase Oil Level

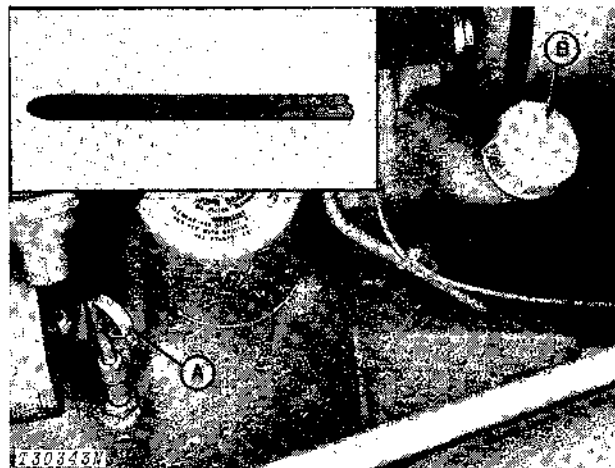

A—Dipstick

B—Oil Filler Cap

Fig. 3-Crankcase Oil Level

Check crankcase oil level with machine on level ground. (Allow a minimum of 10 minutes for the oil to drain down before checking. If oil level is at or below bottom mark on dipstick, add oil specified on page 10-15-1 to bring oil level to between marks on dipstick. Do not operate engine with oil level below the bottom mark.

Crankcase oil level checked Yes No
 Oil added qts (L)

6. Transmission-Hydraulic Oil Level

Check transmission-hydraulic oil level.

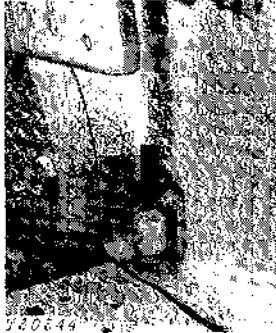

Fig. 4-Transmission-Hydraulic System Dipstick Resting On Top Threads

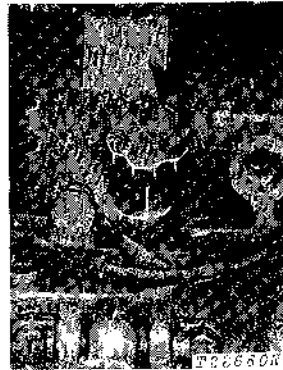

Fig. 5-Transmission-Hydraulic System Filler Cap

Run engine two to three minutes to fill oil circuits. Check oil level with machine on level ground, engine running at slow idle, rockshaft and any equipment lowered, reverser lever locked in neutral, parking brake engaged (if equipped), range shift lever in park, and clutch engaged. Remove dipstick and wipe oil off. Insert dipstick with cap resting on threads of tube (not screwed in place). If oil level is down to bottom mark on dipstick, add oil. Remove filler cap on rockshaft housing and add oil specified on page 10-15-1 to bring oil level to top mark on dipstick.

Oil level checked	Yes	No
Oil added		qts. (L)

7. Fuel Tank

Fill fuel tank with correct fuel. Check action of fuel gauge.

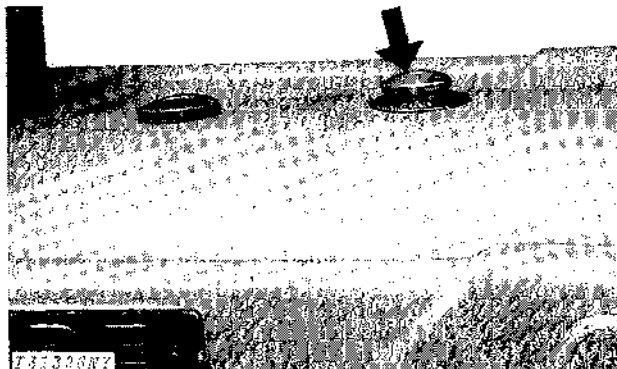
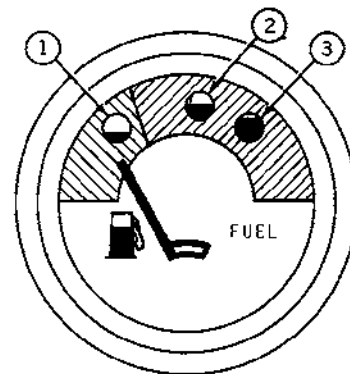

Fig. 6-Fuel Tank Filler Cap



1—Empty Tank 2—Half Full Tank
 3—Full Tank

Fig. 7-Fuel Gauge

Fuel tank filled	Yes	No
Fuel gauge checked	Yes	No

8. Grease Fittings

All grease fittings were lubricated and checked before the unit left the factory. However, to insure customer satisfaction, check each fitting shown on the following pages. Lubricate, if necessary, with John Deere Multi-Purpose Grease or an equivalent.

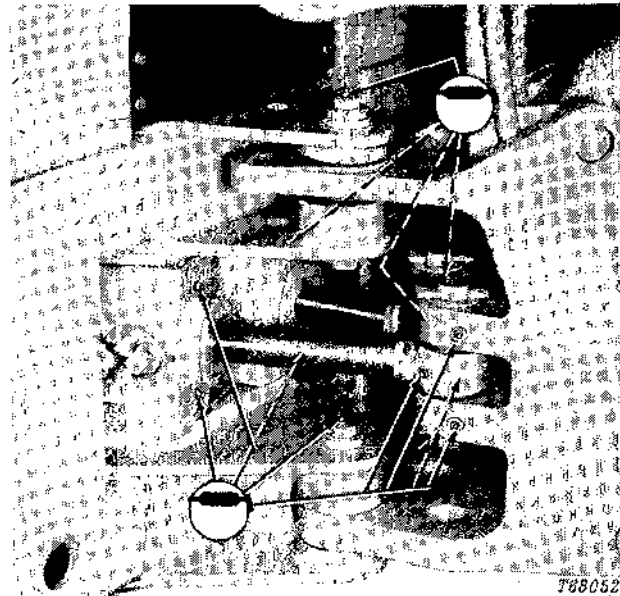
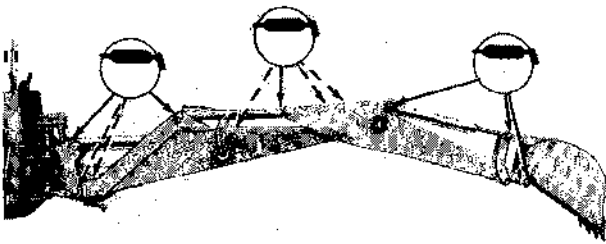

Fig. 8-Backhoe Pivot Points (12 points)

Lubrication required	Yes	No
----------------------	-----	----



T68051X

Fig. 9-Backhoe Boom Pivots (11 points)

Lubrication required Yes No

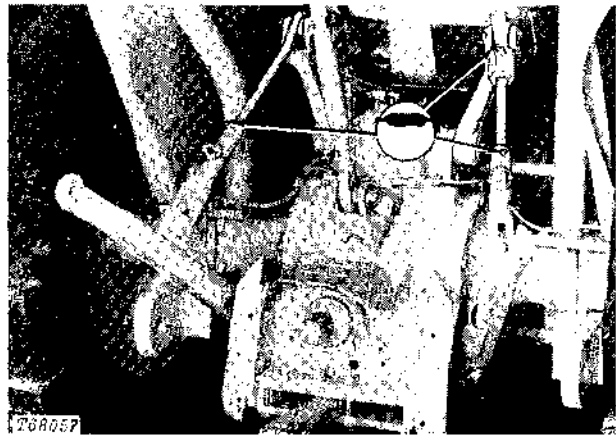

T68057

Fig. 12-3-Point Hitch (3 points)

Lubrication required Yes No

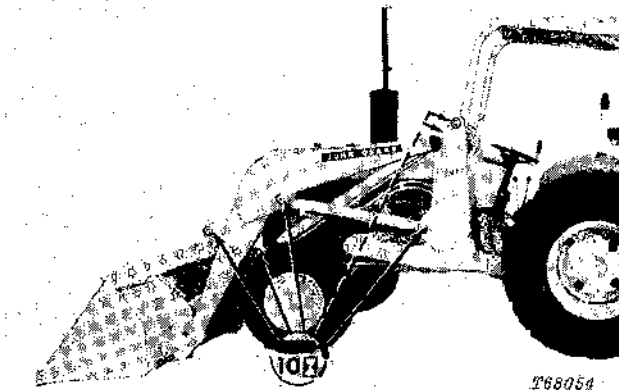

T68054

Fig. 10-Loader Pivot Points (12 points)

Lubrication required Yes No

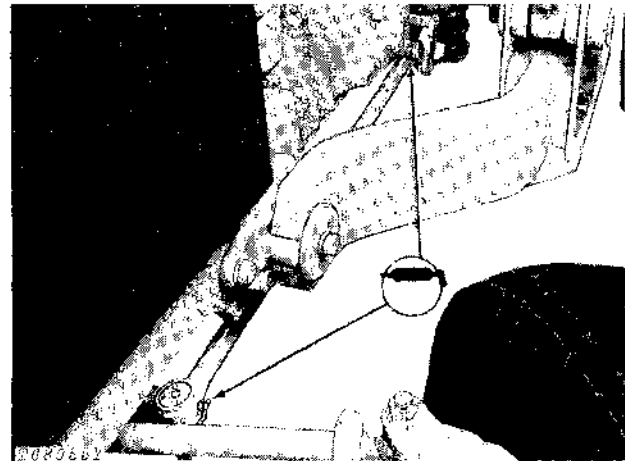

T68055

Fig. 13-Drag Links (2 points)

Lubrication required Yes No

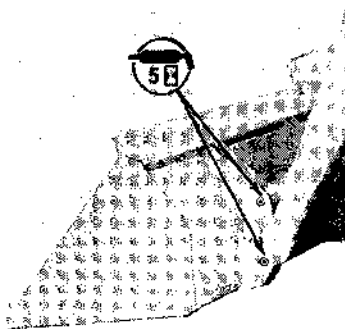

T32442

Fig. 11-Bucket Pivots (4 points)

Lubrication required Yes No

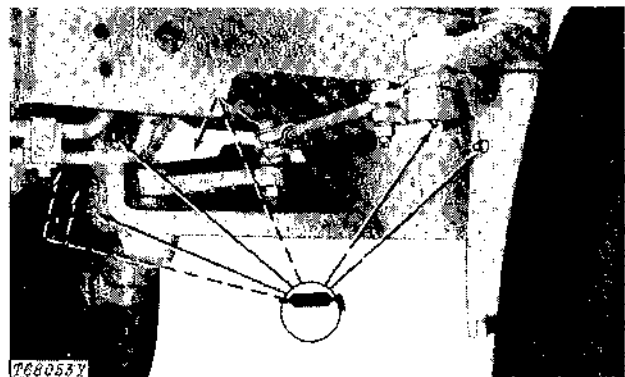

T68053Y

Fig. 14-Front Axle Pivot Points (8 points)

Lubrication required Yes No

9. Air Intake Hoses

Check clamps on hoses connecting air cleaner and engine. Tighten hose clamps where necessary. Inspect hoses for cracks.

Intake hoses checked Yes No

10. Alternator-Fan Belt Tension

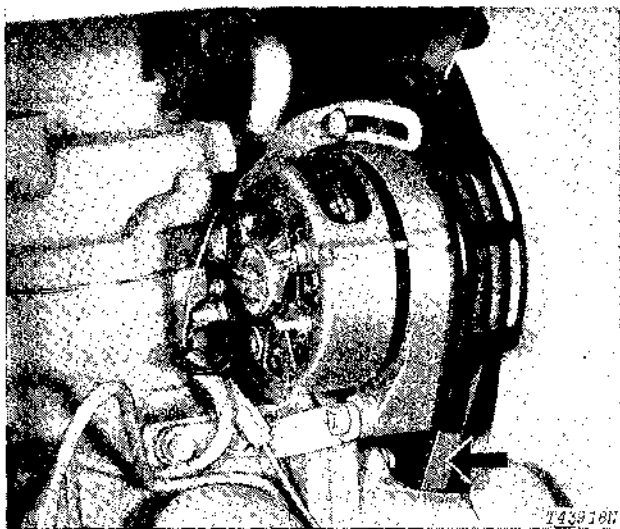

Fig. 15-Alternator-Fan Belt Tension

Check alternator belt tension. Loosen the alternator bracket and adjusting cap screws. Apply outward force to the FRONT alternator frame until 20 lb (9 kg) force on the belt midway between the pulleys will deflect the belt 3/4 inch (19 mm). If a strand tension gauge is used, strand tension must be 90 lb (41 kg).

IMPORTANT: Do not pry on the rear half of the alternator housing.

Belt tension checked Yes No

11. Engine Speeds

Check engine speeds.

- Slow idle - 825 rpm
- Fast idle - 2650 rpm hand throttle
 2800 rpm foot throttle

If adjustment is needed, see page 10-10-20.

Engine speeds checked Yes No

12. Fuel Filter

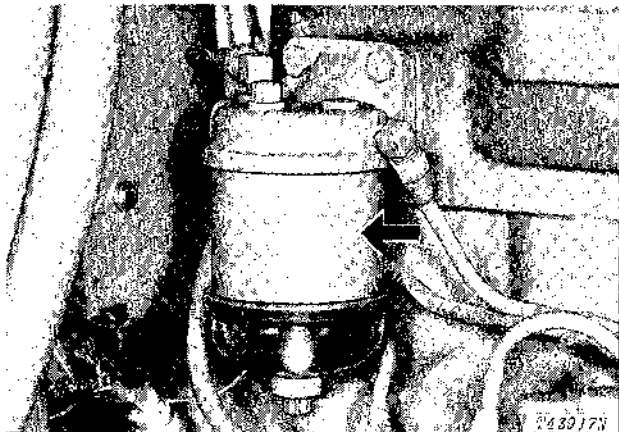

Fig. 16-Fuel Filter

Check fuel filter for sediment and drain if necessary.

Fuel filter checked Yes No

13. Indicator Lights and Gauges

Check operation of indicator lights.

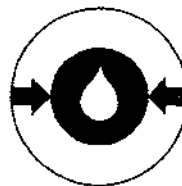

Fig. 17-Engine Oil Pressure Indicator Light

If light glows red when engine is running, stop engine immediately and determine cause.



Fig. 18-Alternator Indicator Light

Light glows red when alternator is not charging. When light goes on with engine running, stop engine and determine cause.