

# JOHN DEERE 7640 KNUCKLEBOOM LOADER



## TECHNICAL MANUAL JOHN DEERE 7640 KNUCKLEBOOM LOADER

TM1148 (01APR76) English

**TM1148 (01APR76)**

LITHO IN THE U.S.A.  
ENGLISH

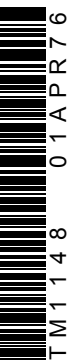

**Thanks very much for your reading,  
Want to get more information,  
Please click here, Then get the complete  
manual**

**JustClickHere** 

**NOTE:**

**If there is no response to click on the link above,  
please download the PDF document first, and then  
click on it.**

**Have any questions please write to me:  
[admin@servicemanualperfect.com](mailto:admin@servicemanualperfect.com)**



## 7640 KNUCKLEBOOM LOADER

### Technical Manual TM-1148 (Apr-76)

#### CONTENTS

Section 10 - GENERAL	Section 50 - HYDRAULIC SYSTEM
Group 5 Specifications	Group 5 General Information and Malfunction Diagnosis
Group 10 Lubricants	Group 10 Hydraulic Pump
Group 15 Separation	Group 15 Reservoir, Filters, and Oil Cooler
Section 20 - ENGINE	Group 20 Main Valve
Group 5 - Diagnosing Malfunctions	Group 25 Stabilizer Valve
Group 10 Separation and Installation	Group 30 Swing Motor
Group 15 Basic Engine	Group 35 Motion Control Valve
Group 20 Engine Lubrication	Group 40 Hydraulic Swivel
Group 25 Speed Control Linkage	Group 45 Selector Valve
Group 30 Engine Cooling System	Group 50 Grapple Inline Crossover Relief Valve
Group 35 Specifications and Special Tools	Group 55 Hydraulic Cylinders
Section 30 - FUEL SYSTEM	Group 60 Control Lever Linkage
Group 5 Diagnosing Malfunctions	Group 65 Grapple Standard Orbit Motor
Group 10 Fuel Tank, Fuel Filter, Fuel Transfer Pump	Group 70 Grapple High Torque Orbit Motor
Group 15 Fuel Injection Pump	Group 75 Specifications
Group 20 Specifications	Section 60 - MISCELLANEOUS
Section 40 - ELECTRICAL SYSTEM	Group 5 Grapples
Group 5 Wiring Diagrams	Group 10 Stabilizer
Group 10 Charging System	Group 15 Cab
Group 15 Starting Motor	
Group 20 Electrical Swivel	
Group 25 Specifications	

#### SI (International System) UNITS OF MEASURE

Metric equivalents have been included, where applicable, throughout this technical manual.

All information, illustrations and specifications contained in this technical manual are based on the latest information available at the time of publication. The right is reserved to make changes at any time without notice.

Copyright® 1976  
DEERE & COMPANY  
Moline, Illinois  
All rights reserved

## INTRODUCTION

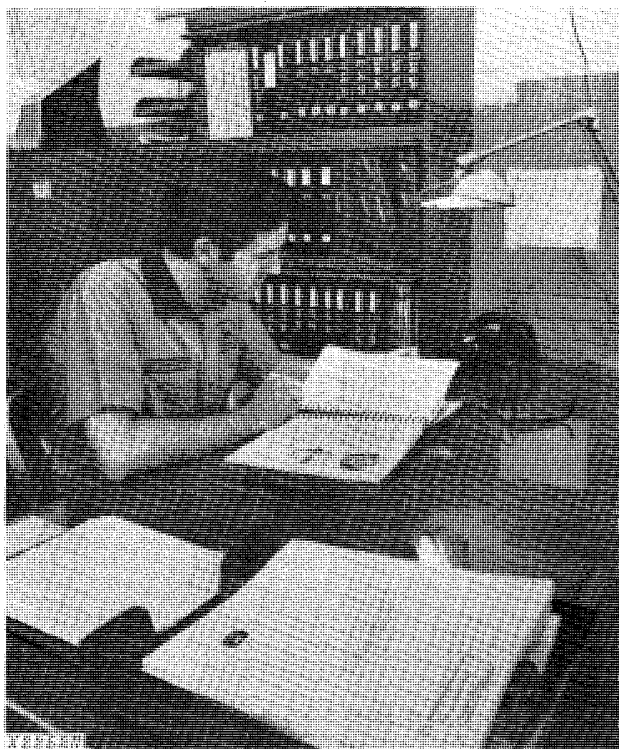

*Use FOS Manuals for Reference*

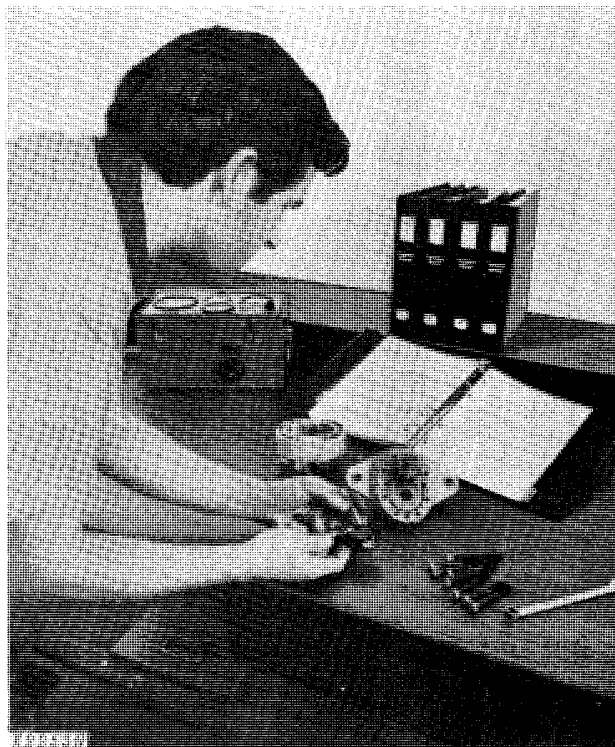

*Use Technical Manuals for Actual Service*

This technical manual is part of a twin concept of service:

### **FOS Manuals - for reference**

### **Technical Manuals - for actual service**

The two kinds of manuals work as a team to give you both the general background and technical details of shop service.

Fundamentals of Service (FOS) Manuals cover basic theory of operation, fundamentals of trouble shooting, general maintenance, and basic types of failures and their causes. FOS Manuals are for training new personnel and for reference by experienced service technicians.

Technical Manuals are concise service guides for a specific machine. Technical Manuals are on-the-job guides containing only the vital information needed by an experienced service technician.

Some features of this technical manual:

- Table of contents at front of manual
- Exploded views showing parts relationship
- Photos showing service techniques
- Specifications grouped for easy reference

This technical manual was planned and written for you - an experienced service technician. Keep it in a permanent binder in the shop where it is handy. Refer to it whenever in doubt about correct service procedures or specifications.

Using the technical manual as a guide will reduce error and costly delay. It will also assure you the best in finished service work.

## MAINTENANCE WITHOUT ACCIDENT WORK SAFELY



T27999N

 This safety alert symbol identifies important safety messages in this manual and on the loader. When you see this symbol, be alert to the possibility of personal injury and carefully read the message that follows.

**EVERY EMPLOYER HAS A  
SAFETY PROGRAM. KNOW  
WHAT IT IS!**

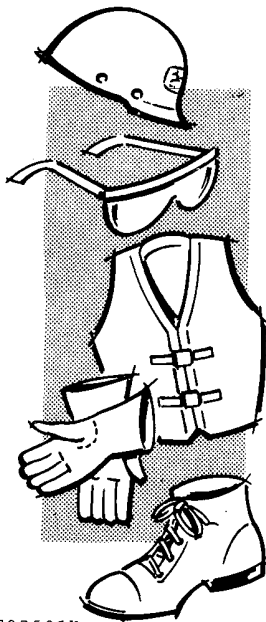

T27501N

Consult your shop supervisor for specific instructions on a job, and the safety equipment required.

For instance, you may need: Hard hat, safety shoes, safety goggles, heavy gloves, reflector vests, ear protectors, respirators.

Litho in U.S.A.



T27502N

ALWAYS AVOID loose clothing or any accessory - flopping cuffs, dangling neckties and scarves, or rings and wrist watches - that can catch in moving parts and put you out of work.

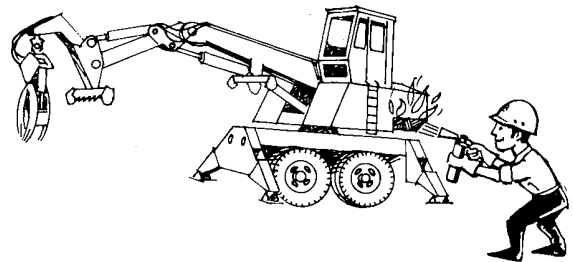

G8396N

### BE ALERT!

Plan ahead—work safely—avoid accidental damage and injury. If a careless moment does cause an accident or fire, react quickly with the tools and skills at hand—know how to use a first aid kit and a fire extinguisher—and where to get aid and assistance. In an emergency split-second action is the key to safety.

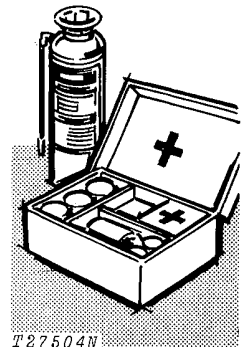

T27504N

## MAINTENANCE WITHOUT ACCIDENT—Continued

Specific safety procedures should always be observed, whether servicing the equipment or making the repairs. Remembering these—in time!—can prevent an injury ... or save your life ...

### AVOID FIRE HAZARDS

#### Fuel is Dangerous!

Don't smoke while refueling.

Don't smoke while handling highly flammable material.

Engine should be shut off when refueling.

Use care in refueling if the engine is hot.

Don't use open pans of gasoline or diesel fuel for cleaning parts. Good commercial, nonflammable solvents are preferred.

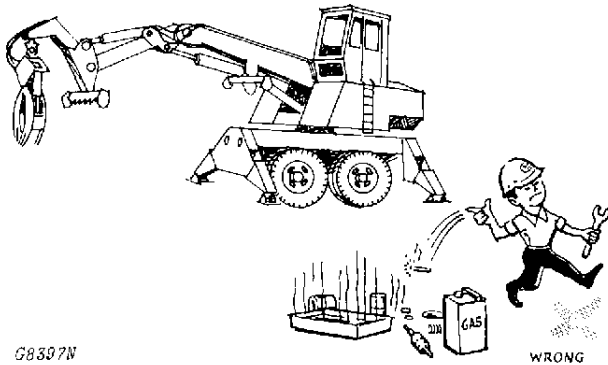

#### Battery Gas Is Highly Flammable!

Provide adequate ventilation when charging batteries.

Don't check battery charge by placing metal objects across the posts.

Don't allow sparks or open flame near batteries.

Don't smoke near battery.

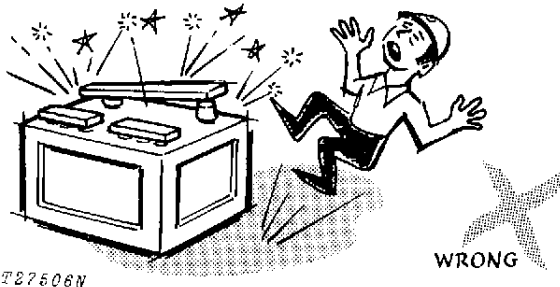

#### Flame Is Not A Flashlight!

Never check fuel, battery electrolyte or coolant levels with an open flame.

Never use an open flame to look for leaks anywhere on the equipment.

Never use an open flame as a light anywhere on or around the equipment.

KNOW WHERE FIRE EXTINGUISHERS ARE KEPT!

### UNDER ALL MAINTENANCE CONDITION -

Do not perform any work on the equipment unless authorized to do so. Then be sure you know what you're doing. Follow recommended procedures.

Never service the equipment while it is being operated.

Avoid working on equipment with the engine running. If it is necessary to make checks with the engine running, ALWAYS USE TWO SERVICE TECHNICIANS—one, the operator, at the controls, the other checking in view of the operator. Also, put the transmission in neutral, set the brake, and apply any safety locks provided. KEEP HANDS AWAY FROM MOVING PARTS.

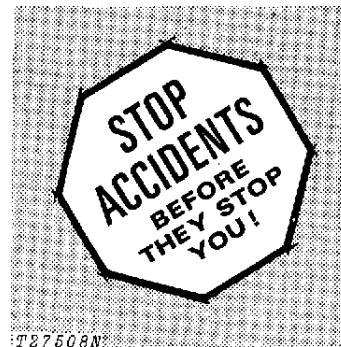

## MAINTENANCE WITHOUT ACCIDENT

Before servicing, adjusting, or repairing - LOWER attachments to the ground - or, if necessary to raise them for access to certain parts, SECURELY SUPPORT by external means. DO NOT rely on controls to support or position attachments for maintenance.

Never allow ANYONE to walk under equipment that is raised and not properly blocked.

Avoid working directly under raised and blocked equipment unless absolutely necessary.

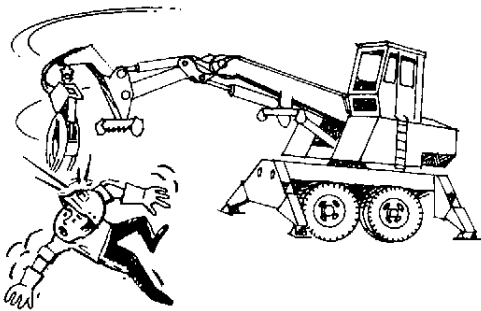

G8398N

If the machine is on an incline, block it securely.

Use hoisting equipment for lifting heavy parts. TAKE CARE! WATCH OUT FOR OTHER PEOPLE IN THE VICINITY.

Use extreme caution in removing radiator caps, drain plugs, grease fittings, or hydraulic pressure caps.

Wear safety glasses when drilling, grinding, or hammering metal.

Make sure the maintenance area is adequately vented.

Keep maintenance area CLEAN AND DRY. Oily and wet floors are slippery; greasy rags are a fire hazard; wet spots are dangerous when working with electrical equipment.

Store starting aids in a cool and well-ventilated place, out of the reach of unauthorized personnel.

### SERVICING PRECAUTIONS

Stop the engine before cleaning or lubricating the equipment.

Lower mounted equipment and tools to the ground carefully.

Engine coolant gets hot! Don't remove the radiator cap until coolant temperature is below the boiling point. Then turn cap slightly to relieve pressure before removing.

Exhaust gases are dangerous! Periodically check exhaust system for excessive leakage.

Don't forget a hydraulic system may be pressurized! To relieve pressure, follow the technical manual.

When checking hydraulic pressure, be sure to use the correct test gauge for the pressure in the particular system.



## MAINTENANCE WITHOUT ACCIDENT—Continued

Keep ALL equipment free of dirt and oil. This attention will minimize fire hazards and facilitate spotting of loose or defective parts.

When preparing engine for storage, remember that inhibitor is volatile and therefore dangerous. Seal and tape openings after adding the inhibitor. Keep container tightly closed when not in use.

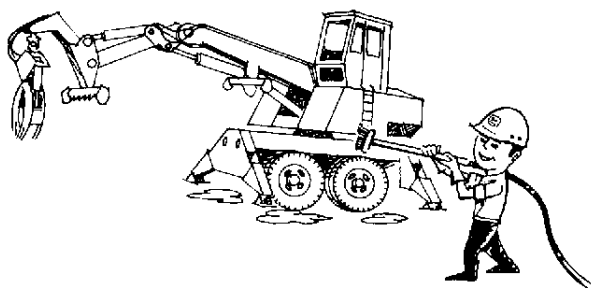

G8399N

Before removing any housing covers, stop engine. Take all objects from your pockets which could fall into the opened housings. Don't let adjusting wrenches fall into opened housing.

### .... for Maintenance Adjustments

Don't attempt to check belt tension while the engine is running.

Don't adjust the fuel system while the machine is in motion.

## PRECAUTIONS DURING REPAIR

Before working on the engine fuel system—close fuel shutoff valve.

Before working on hydraulic system—make sure engine is not running and the system pressure is relieved by working the control levers in all directions with the engine shut off.

Never let your bare hands come in contact with the sharp edges. WEAR GLOVES.

Before repairing the electrical system, or performing a major overhaul, make sure the batteries are disconnected.

# Section 10 GENERAL

## CONTENTS OF THIS SECTION

### GROUP 5 - SPECIFICATIONS

7640 Loader Design .....	5-3
Serial Number .....	5-3
Loader Specifications .....	5-4
Grapples .....	5-5
Boom Lift Capacities .....	5-6
Side View .....	5-7
Rear View .....	5-8

### GROUP 10 - LUBRICANTS

Lubricants .....	10-1
Lubrication and Periodic Service .....	10-2
Lubrication and Service Intervals .....	10-2
Periodic Service Chart .....	10-3-10-4
Rear Mount Lubrication .....	10-5-10-8

### GROUP 15 - SEPARATION

General .....	15-1
Separating the 7640 from the truck .....	15-2
Installing Loader Onto Truck .....	15-3



## Group 5 SPECIFICATIONS

### 7640

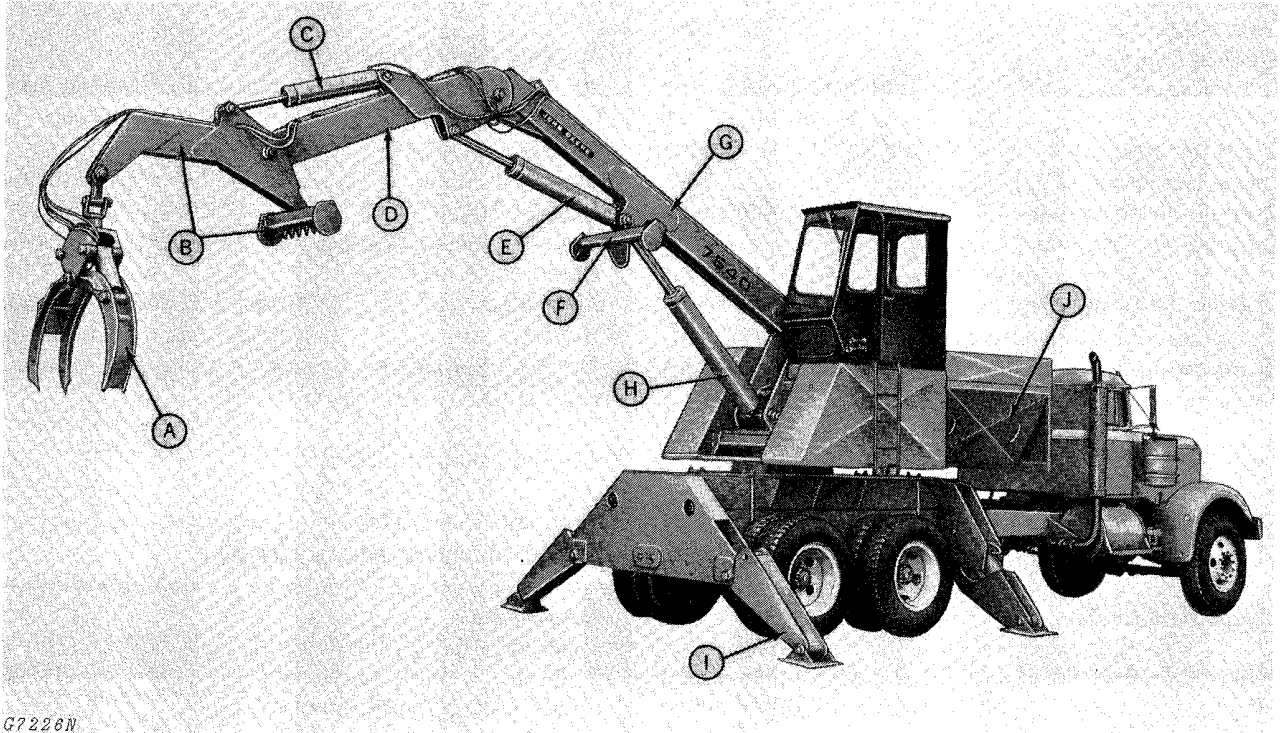

- A—Stabilizer
- B—Operating Platform
- C—Hand Railing
- D—Jib Boom
- E—Jib Cylinder

- F—Heel
- G—Main Boom
- H—Main Cylinder
- I—Stabilizer
- J—Engine Access Panel

Fig. 1—John Deere 7640 Knuckleboom Loader with 44-Inch (1.11 m) Grapple

### SERIAL NUMBER

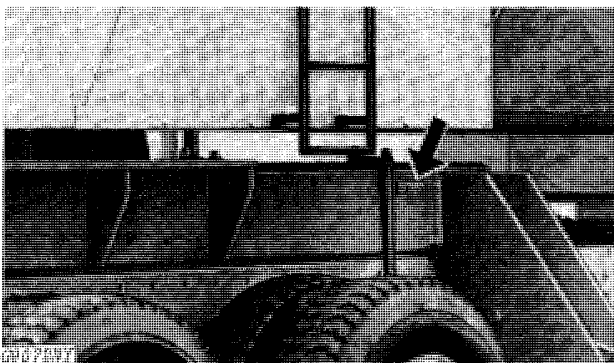

Fig. 2—Serial Number

The loader serial number on the 7640 Knuckleboom Loader is located on the lower rear left-hand side of the mounting frame.

## LOADER SPECIFICATIONS

### Operating Information:

Maximum loading reach	32 ft. (9.75 m)
Swing system	Turntable
Swing arc	360° continuous
Swing torque	28,000 lb-ft (3872 kg-m)
Swing speed	5 rpm
Stabilizer spread:	
front	11 ft. 6 in. (3.51 m)
rear	15 ft. 4 in. (4.67 m)
Stabilizer area, each	256 sq. in. (1652 cm <sup>2</sup> )
Grapple rotation	360°
Grapple swing torque	175 lb-ft (24.2 kg-m)
Grapple opening, maximum:	
40 in. (1.02 m) grapple	40 in. (1.02 m)
44 in. (1.12 m) grapple	44 in. (1.12 m)
1/4 cord (0.9 m <sup>3</sup> ) grapple	50 in. (1.27 m)
Transport height	13 ft. (3.96 m)
Maximum transport width	8 ft. (2.44 m)

### Mounting:

Mounting frame integral with main frame. Brackets supplied for universal mounting. Bolts to truck frame.

### Hydraulic Cylinders:

Main	8x48 in. (203 x 1219 mm), double-acting
Jib	7x36 in. (178 x 914 mm), double-acting
Live heel	6x24 in. (152 x 610 mm), double-acting
Stabilizer	6x21 in. (152 x 533 mm), double-acting
Grapple:	
40 in. (1.02 m) and 1/4 cord (0.9 m <sup>3</sup> ), 3-1/2x8 in. (82 x 203 mm), double-acting	
44-in. (1.12 m) 4x10 in. (102x254 mm), double-acting	

### Hydraulic System:

Controls	2-lever, stack valve
Relief pressure	2050 psi (14132 kp/cm <sup>2</sup> )
Pump	90 gpm (341 l/min) at 1800 rpm
Reservoir capacity	57 gal. (215.8 l)

### Auxiliary Diesel Power Unit:

John Deere, 6-cylinder, valve-in-head, 4-stroke cycle.	
Power (@ 2500 rpm), intermittent	104 hp (78 kW*)110.5 DIN-PS
Bore and stroke	4.02x4.33 in. (102x110 mm)
Piston displacement	32.9 cu. in. (5391 cm <sup>3</sup> )
Rotation, facing flywheel end	Counterclockwise
Compression ratio	16.3 to 1
Alternator	12 volt, 55 amp w/regulator
Starter	12 volt (no battery and cables)

\*In the International System of Units (SI), power is expressed in kilowatts (kW).

### Shipping Weight (approx)

Complete with stabilizers, all cylinders, hydraulic pump and all mounting, less grapples:

15,336 lb (6970 kg)

### Grapples:

40 in. (1.02 m) interlocking	585 lb. (265 kg)
44 in. (1.12 m) interlocking	695 lb. (315 kg)
1/4 cord (0.9 m <sup>3</sup> ) general purpose	620 lb. (281 kg)

### GRAPPLES

Three types of grapples are available, each with the standard orbital motor or a high torque orbital motor.

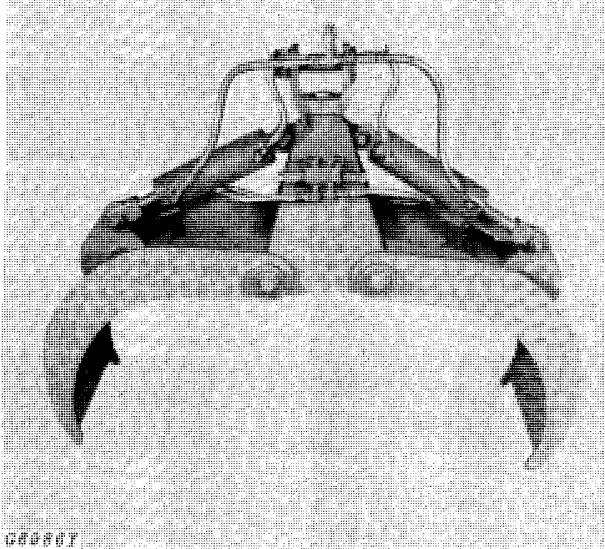

Fig. 3-One Quarter Cord Grapple

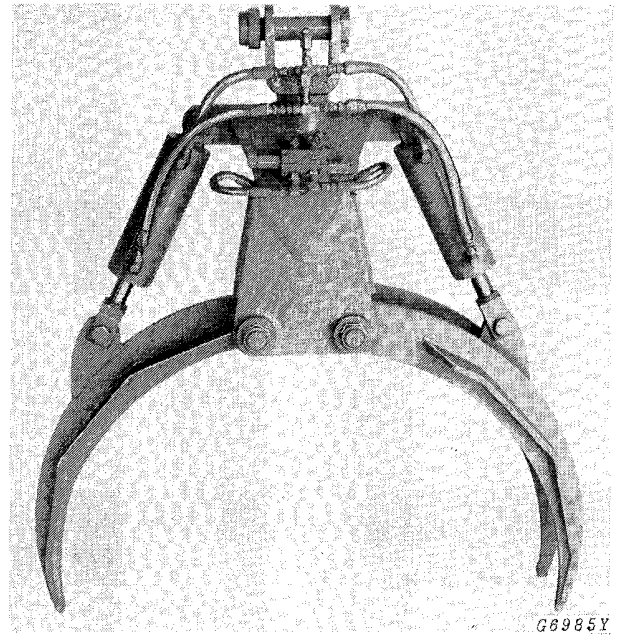

Fig. 5-Forty-Inch (1.01 m) Grapple

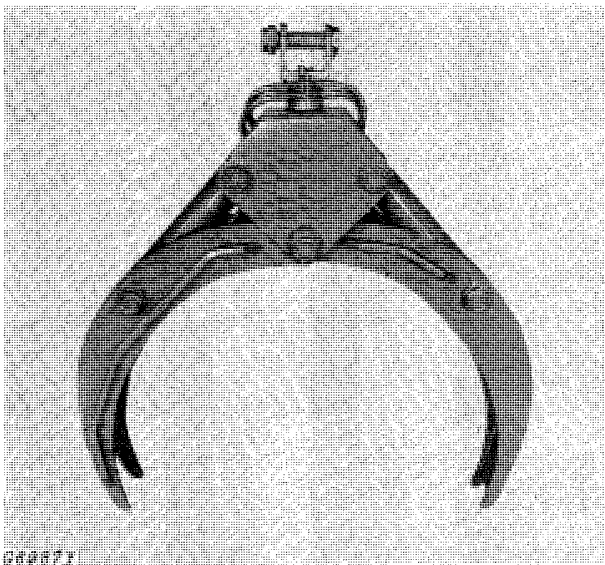
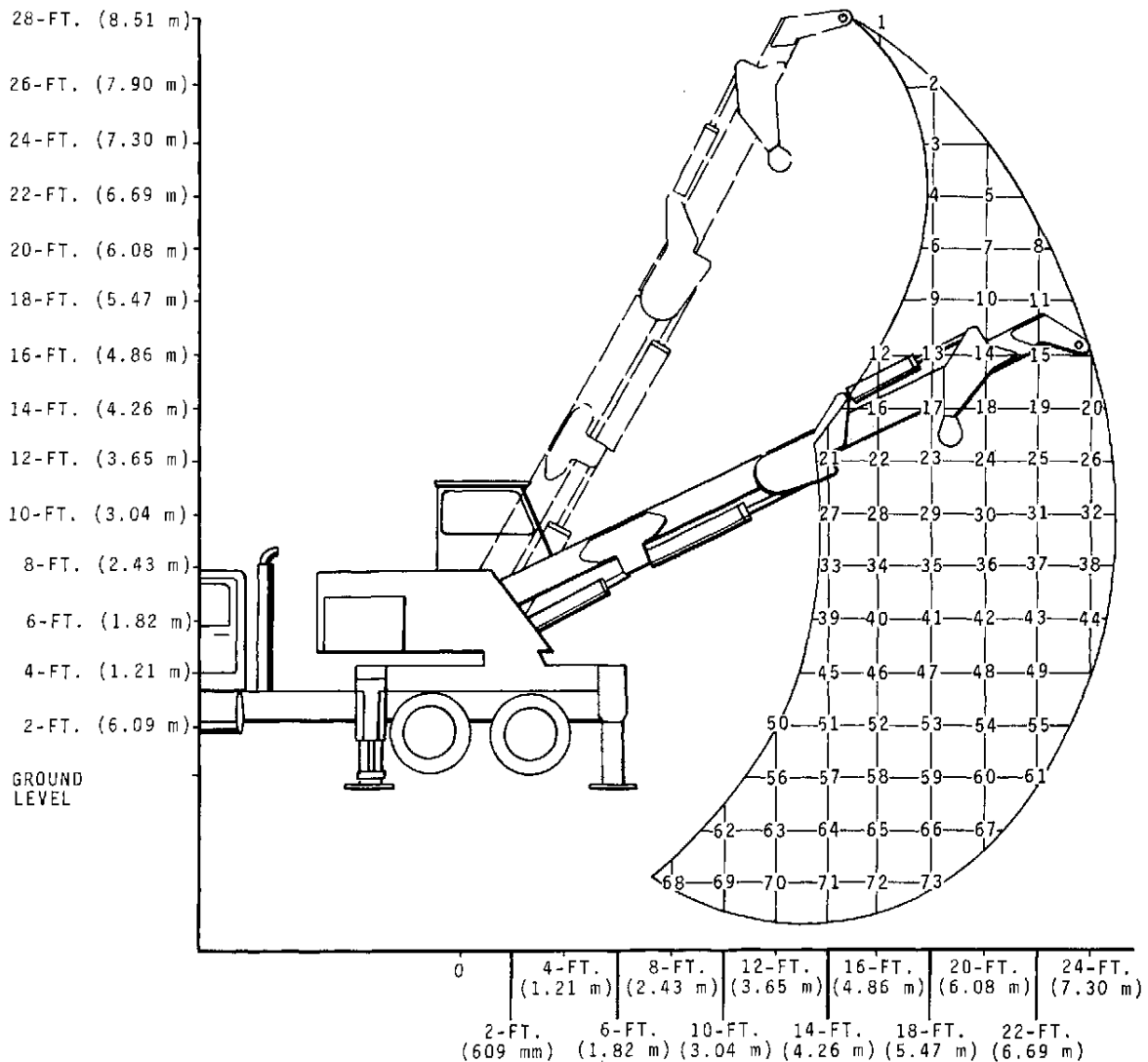

Fig. 4-Forty-Four-Inch (1.11 m) Grapple

### BOOM LIFT CAPACITIES



G7223H

1. 8940 lbs. (39.8 kN)	21. 14370 lbs. (63.9 kN)	41. 15870 lbs. (70.6 kN)	61. 9790 lbs. (43.5 kN)
2. 8110 lbs. (36.1 kN)	22. 13970 lbs. (62.1 kN)	42. 14430 lbs. (64.2 kN)	62. 26290 lbs. (116.9 kN)
3. 10110 lbs. (45.0 kN)	23. 13330 lbs. (59.3 kN)	43. 11460 lbs. (51.0 kN)	63. 23520 lbs. (104.6 kN)
4. 10940 lbs. (48.7 kN)	24. 12010 lbs. (53.4 kN)	44. 7240 lbs. (32.2 kN)	64. 20130 lbs. (89.5 kN)
5. 9090 lbs. (40.4 kN)	25. 11020 lbs. (49.0 kN)	45. 20610 lbs. (91.7 kN)	65. 17400 lbs. (77.4 kN)
6. 10970 lbs. (48.8 kN)	26. 7270 lbs. (32.3 kN)	46. 18110 lbs. (80.6 kN)	66. 15020 lbs. (66.8 kN)
7. 10240 lbs. (45.5 kN)	27. 16910 lbs. (75.2 kN)	47. 16150 lbs. (71.8 kN)	67. 12610 lbs. (56.1 kN)
8. 6730 lbs. (29.9 kN)	28. 16150 lbs. (71.8 kN)	48. 14510 lbs. (64.5 kN)	68. 18840 lbs. (83.8 kN)
9. 11150 lbs. (49.6 kN)	29. 14880 lbs. (66.2 kN)	49. 11420 lbs. (50.8 kN)	69. 25910 lbs. (115.3 kN)
10. 10900 lbs. (48.5 kN)	30. 13030 lbs. (58.0 kN)	50. 24440 lbs. (108.7 kN)	70. 21940 lbs. (97.6 kN)
11. 8730 lbs. (38.8 kN)	31. 11190 lbs. (49.8 kN)	51. 20940 lbs. (93.1 kN)	71. 18740 lbs. (83.4 kN)
12. 11930 lbs. (53.1 kN)	32. 7820 lbs. (34.8 kN)	52. 18290 lbs. (81.4 kN)	72. 16010 lbs. (71.2 kN)
13. 11470 lbs. (51.0 kN)	33. 18930 lbs. (84.2 kN)	53. 16170 lbs. (71.9 kN)	73. 13400 lbs. (59.6 kN)
14. 11070 lbs. (49.2 kN)	34. 16950 lbs. (75.4 kN)	54. 14350 lbs. (63.8 kN)	
15. 9810 lbs. (43.6 kN)	35. 15430 lbs. (68.6 kN)	55. 10800 lbs. (48.0 kN)	
16. 12550 lbs. (55.8 kN)	36. 14150 lbs. (62.9 kN)	56. 24320 lbs. (108.2 kN)	
17. 12160 lbs. (54.1 kN)	37. 11320 lbs. (50.4 kN)	57. 20820 lbs. (92.6 kN)	
18. 11340 lbs. (50.4 kN)	38. 7870 lbs. (35.0 kN)	58. 18090 lbs. (80.5 kN)	
19. 10670 lbs. (47.5 kN)	39. 19910 lbs. (88.6 kN)	59. 15850 lbs. (70.5 kN)	
20. 5960 lbs. (26.5 kN)	40. 17640 lbs. (78.5 kN)	60. 13800 lbs. (61.4 kN)	

These lift values are obtained by use of the boom and jib cylinders and do not account for any additional lift that could be obtained by use of the live heel cylinder for lifting.

Fig. 6-Boom Lift Capacities

**SIDE VIEW**

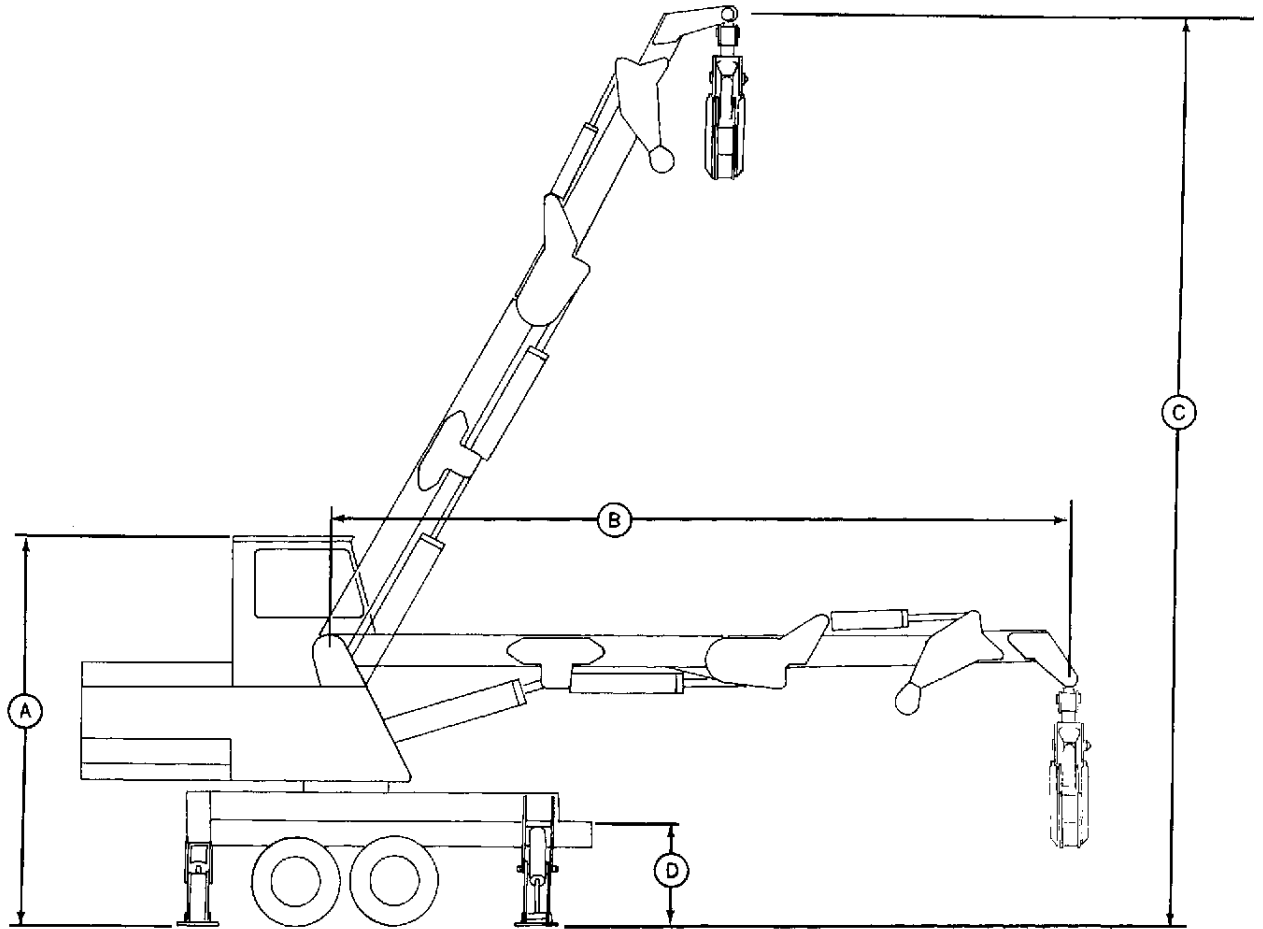

G7218N

A—Transport Height—13 Ft. (3.96 m)  
B—Boom Length—25 Ft. (7.62 m)

C—Maximum Reach—32 Ft. (9.75 m)  
D—Average Truck Bed Height—3 Ft. 6 In. (1.06 m)

Fig. 7-7640 Side View



**REAR VIEW**

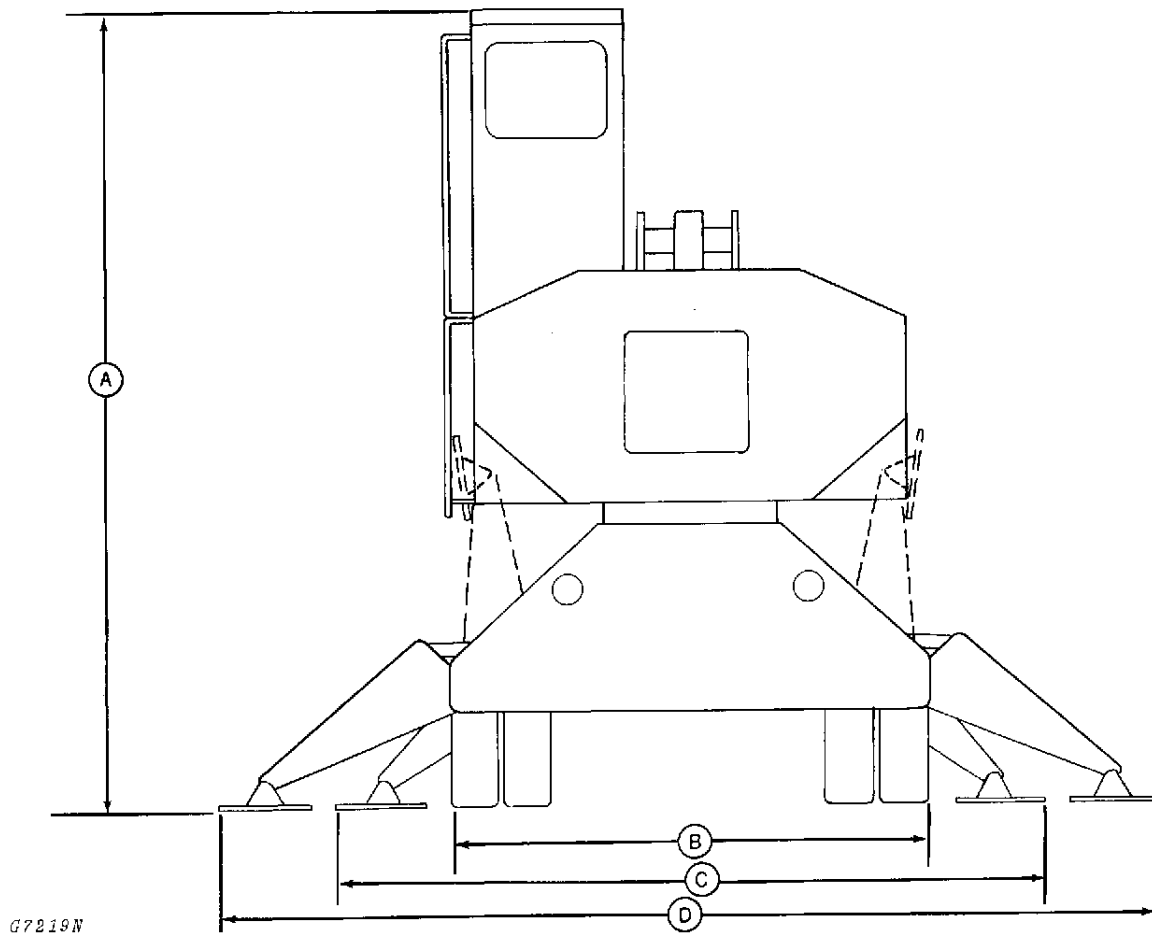

A—Transport Height-13 ft. (3.96 m)  
B—Average Truck Tread Width-8 ft. (2.43 m)

C—Front Stabilizer Spread Width-11 ft. 6 in. (3.5 m)  
D—Rear Stabilizer Spread Width-15 ft. 4 in. (4.67 m)

Fig. 8-Rear View

## Group 10 LUBRICATION

### LUBRICANTS

Effective use of lubricating oils and greases is perhaps the most important step towards low upkeep cost, long engine life, and satisfactory service. Use only lubricants specified in this section; apply them at intervals and according to the instructions in the lubrication and periodic service section.

#### ENGINE LUBRICATING OILS

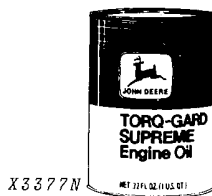

We recommend John Deere Torq-Gard Supreme engine oil for use in the engine crankcase. This oil is compounded specifically for use in John Deere engines and provides superior lubrication under all conditions. NEVER PUT ADDITIVES IN THE CRANKCASE. Torq-Gard Supreme oil is formulated to provide all the protection your engine needs. Additives could reduce this protection rather than help it.

If oil other than Torq-Gard Supreme is used, it must conform to one of the following specifications for all John Deere engines:

##### Single Viscosity Oils

API Service CD/SD  
MIL-L-2104C  
Series 3

##### Multi-Viscosity Oils

API Service CC/SD  
MIL-L-46152

Depending on the expected prevailing temperature for the fill period, use oil viscosity as shown in the following chart.

Air Temperature	John Deere Torq-Gard Oil	Other Oils	
		Single Viscosity Oil	Multi-Viscosity Oil
Above 32°F (0°C)	SAE 30	SAE 30	Not recommended
-10°F to 32°F (-23°C to 0°C)*	SAE 10W-20	SAE 10W	SAE 10W-30
Below -10°F (-23°C)	SAE 5W-20	SAE 5W	SAE 5W-20

\*SAE 5W-20 oil may also be used to insure optimum lubrication at starting, particularly when engine is subjected to -10°F (-23°C) or lower temperatures for several hours.

Some increase in oil consumption may be expected when SAE 5W-20 or SAE 5W oils are used. Check oil level more frequently.

#### STORING LUBRICANTS

Your engine can operate at top efficiency only if clean lubricants are used. Use clean containers to handle all lubricants. Store them in an area protected from dust, moisture, and other contamination.

Do not handicap your engine by using inferior or incorrect oil and grease. Use only quality lubricants at the specified intervals.

#### HYDRAULIC OILS

Use only John Deere Hy-Gard Hydraulic Oil or its equivalent in the hydraulic system reservoir.

For temperatures of 0°F to 30°F (-17.7°C to -1.1°C) use John Deere All Weather Hydrostatic Fluid.

#### GREASES

Use John Deere Multi-Purpose lubricant or an equivalent SAE multipurpose-type grease for all grease fittings. Application of grease as instructed in the lubrication section will provide proper lubrication and will keep loader in top operating condition.

## LUBRICATION AND PERIODIC SERVICE

The instructions on the following pages will help you perform recommended service at proper intervals. Performing the services as instructed will result in long, reliable service.

The intervals at which the various working parts of your knuckleboom should be checked, lubricated, serviced, or adjusted are based on hours of operation.

*NOTE: For engine lubrication refer to the engine operator's manual.*

After the first 50 hours of loader operation change the return line filter in the loader reservoir.

### KEEP LUBRICANTS CLEAN!

Use only high-grade lubricants which have been stored in clean containers. Wipe away all grease and dirt before removing filler caps or plugs.

### LUBRICATION AND SERVICE INTERVALS

The lubrication and service intervals for this knuckleboom are based on operation under average conditions. When the knuckleboom is operated under unusual conditions, such as excessive heat, cold, dust, frequent starts and stops, or with poor quality fuels or lubricants, the knuckleboom should be serviced at MORE FREQUENT INTERVALS.



Lubricate with John Deere Multi-Purpose Lubricant or an equivalent SAE multipurpose-type grease at hourly intervals indicated on the symbols.



Lubricate Every 10 Hours of Operation with John Deere Hy-Gard Hydraulic Oil or its equivalent.



Oil periodically with John Deere Torq-Gard Supreme Engine Oil or an equivalent SAE 30 oil.

The chart which follows is a condensed list of the knuckleboom components to be serviced at each interval and the service to be performed. Detailed instructions for performing each service are given on the pages which follow the chart. Each item in the chart is numbered, with the corresponding detailed procedure bearing the same number.

Perform the indicated services at the time intervals specified in the chart.