



**570, 575  
and 375  
Skid-Steer  
Loaders**



**John Deere Horicon Works**  
**TM1359 (20APR90)**



LITHO IN U.S.A.  
ENGLISH

# Contents

## SECTION 10—GENERAL INFORMATION

- Group 05—Introduction and Safety
- Group 10—General Specifications
- Group 15—Cap Screw Torque
- Group 20—Tune-Up
- Group 25—Fuel and Lubrication—570
- Group 30—Fuel and Lubrication—575 and 375
- Group 35—Serial Numbers



## SECTION 20—DIESEL ENGINE

- Group 05—Engine Removal and Installation—Model 575
- Group 06—Engine Removal and Installation Model 375
- Group 10—Cooling System



## SECTION 25—GASOLINE ENGINE

- Group 05—Gasoline Engine Removal and Installation
- Group 10—Valve Actuating Means and Camshaft
- Group 15—Manifold, Cylinder Heads and Valves
- Group 20—Flywheel and Housing
- Group 25—Connecting Rods and Pistons
- Group 30—Crankshaft and Main Bearings
- Group 35—Gear Housing
- Group 40—Lubrication System
- Group 45—Cooling System



## SECTION 30—FUEL AND AIR SYSTEM—DIESEL

- Group 05—Throttle Control Linkage
- Group 10—External Fuel Supply



## SECTION 35—FUEL AND AIR SYSTEM (GASOLINE)

- Group 05—Carburetor
- Group 10—Carburetor and Governor Linkages
- Group 15—External Fuel Supply



## SECTION 40—ELECTRICAL

- Group 05—Alternator—Model 570
- Group 10—Starter—Model 570
- Group 15—Seat Lockout Switch



## Index

*All information, illustrations and specifications in this manual are based on the latest information available at the time of publication. The right is reserved to make changes at any time without notice.*

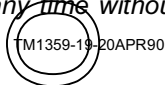

COPYRIGHT©1989  
DEERE & COMPANY  
Moline, Illinois  
All rights reserved  
A John Deere ILLUSTRATION™ Manual



# Contents

## SECTION 50—POWER TRAIN

Group 05—Hydrostatic Pumps—Models 570 and 575

Group 06—Hydrostatic Pump—Model 375

Group 10—Hydrostatic Motors—Models 570 and 575

Group 11—Hydrostatic Motors—Model 375

Group 15—Drive Chains and Axles—Models 570 and 575

Group 16—Drive Chains and Axles—Model 375

Group 20—Drive Shaft



## SECTION 60—STEERING AND BRAKES

Group 05—Park Brake

Group 10—Steering Neutralizer



## SECTION 70—HYDRAULICS

Group 05—Hydraulic Pump—Models 570 and 575

Group 06—Hydraulic Pump—Model 375

Group 10—Main Control Valve

Group 15—Hydraulic Cylinders

Group 20—Miscellaneous Hydraulics

Group 25—Lift Arms, Linkage and Stops



## SECTION 210—SPECIFICATIONS/OPERATIONAL CHECKOUT

Group 01—Test and Adjustment Specifications

Group 05—Machine Operational Checkout

## SECTION 220—ENGINE OPERATION AND TESTS

Group 05—Engine System Checkout—375/575

Group 06—Engine System Checkout—570

Group 10—Engine System Diagnosis—375/575

Group 11—Engine System Diagnosis—570



## SECTION 240—ELECTRICAL OPERATION AND TESTS

Group 05—Electrical System Checkout

Group 10—Electrical System Diagnosis

Group 15—Component Locations and Diagrams



## SECTION 250—POWER TRAIN OPERATION AND TESTS

Group 05—Power Train System Checkout

Group 10—Power Train Tests and Adjustments



*All information, illustrations and specifications in this manual are based on the latest information available at the time of publication. The right is reserved to make changes at any time without notice.*

TM1359-19-20APR90

## SECTION 270—HYDRAULIC OPERATION AND TEST

Group 05—Hydraulic System Checkout

Group 10—Hydraulic System Tests

Group 15—Schematic Diagrams

50

60

70

210

220

240

250

270



**Thanks very much for your reading,  
Want to get more information,  
Please click here, Then get the complete  
manual**

**JustClickHere** 

**NOTE:**

**If there is no response to click on the link above,  
please download the PDF document first, and then  
click on it.**

**Have any questions please write to me:  
[admin@servicemanualperfect.com](mailto:admin@servicemanualperfect.com)**

10

R

20

O

25

O

30

F

35

40

P

INDX

R

O

O



# Section 10

# GENERAL INFORMATION

## Contents

Page

### Group 05—Introduction and Safety

Introduction . . . . .	10-05-1
Safety . . . . .	10-05-2



### Group 10—General Specifications

570 Skid-Steer Loader . . . . .	10-10-1
575 Skid-Steer Loader . . . . .	10-10-3



### Group 15—Cap Screw Torque

Bolt Torque Chart . . . . .	10-15-1
Metric Hardware Torque Specifications . . . . .	10-15-2

### Group 20—Tune-Up

570 and 575 Skid-Steer Loader . . . . .	10-20-1
---	---------



### Group 25—Fuel and Lubrication—570

Fuel . . . . .	10-25-1
Storing and Handling Fuel . . . . .	10-25-1
Engine Oil . . . . .	10-25-2
General Purpose Grease . . . . .	10-25-2
Hydraulic Oil . . . . .	10-25-3

### Group 30—Fuel and Lubrication—575 and 375

Fuel . . . . .	10-30-1
Fuel Specifications . . . . .	10-30-1
Fuel Storage . . . . .	10-30-2
Diesel Engine Oil . . . . .	10-30-3
General Purpose Grease . . . . .	10-30-4
Hydraulic Oil . . . . .	10-30-4



### Group 35—Serial Numbers

Product Identification Number . . . . .	10-35-1
Engine Serial Number . . . . .	10-35-1



R

O

O

F

P

R

O

O

**INTRODUCTION**

This manual is part of a total service support program.

FOS MANUALS—REFERENCE

TECHNICAL MANUALS—MACHINE SERVICE

COMPONENT MANUALS—COMPONENT SERVICE

Fundamentals of Service (FOS) Manuals cover basic theory of operation, fundamentals of troubleshooting, general maintenance, and basic types of failures and their causes. FOS Manuals are for training new personnel and for reference by experienced technicians.

Technical Manuals are concise service guides for specific machines. Technical manuals are on-the-job guides containing only the vital information needed by an experienced service technician.

Component Technical Manuals are concise service guides for specific components. Component Technical Manuals are written as stand alone manuals covering multiple machine applications.



RW5559 -JUN-23AUG88

10  
05  
1

O53,INTRO2 -19-03JUL85



10  
05  
2

### FEATURES OF THIS TECHNICAL MANUAL

John Deere ILLUSTRATION format emphasizing illustrations and concise instructions in easy-to-use modules.



Emphasis on diagnosis, analysis, and testing so you can understand the problem and correct it.

Diagnostic information presented with the most logical and easiest to isolate problems first to help you identify the majority of routine failures quickly.



Step-by-step instructions for teardown and assembly.

Summary listing at the beginning of each group of all applicable specifications, wear tolerances, torque values, essential tools, and materials needed to do the job.



An emphasis throughout on safety—so you do the job right without getting hurt.



This technical manual was planned and written for you—an experienced service technician. Keep it in a permanent binder in the shop where it is handy. Refer to it when you need to know correct service procedures or specifications.



RW5560 -UN-23AUG68



O53.INTRO3 -19-07OCT85

### SAFETY AND YOU

**CAUTION:** This safety symbol is used for important safety messages. When you see this symbol, follow the safety message to avoid personal injury.



T81389 -UN-07DEC88

M45,1005A,3 -19-09JAN85



### PREPARE FOR EMERGENCIES

Be prepared if a fire starts.

Keep a first aid kit and fire extinguisher handy.

Keep emergency numbers for doctors, ambulance service, hospital, and fire department near your telephone.

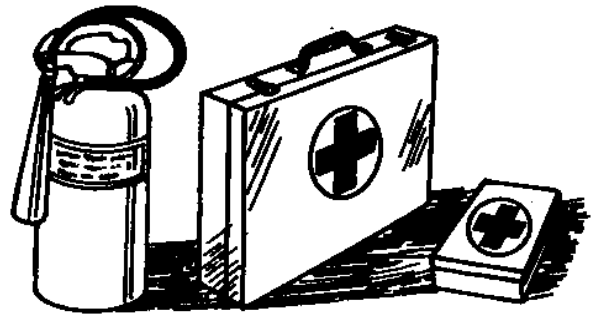

O53,FIRE2 -19-26JAN90

UN-23AUG88  
TS291

### HANDLE FUEL SAFELY—AVOID FIRES

Handle fuel with care: it is highly flammable. Do not refuel the machine while smoking or when near open flame or sparks.

Always stop engine before refueling machine. Fill fuel tank outdoors.

Prevent fires by keeping machine clean of accumulated trash, grease, and debris. Always clean up spilled fuel.

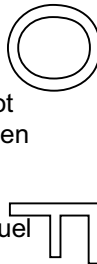

O53,FIRE1 -19-26JAN90

UN-23AUG88  
TS202

### LEARN MACHINE SAFETY

Carefully read this manual. Learn how to operate the machine and how to use the controls properly.

Do not let anyone operate this machine without proper instruction.

Unauthorized modifications to the machine may impair the function and/or safety and affect machine life.

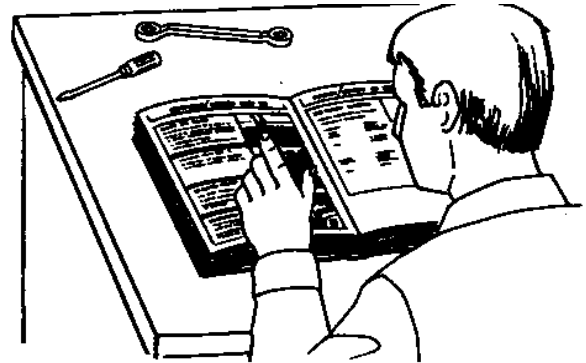
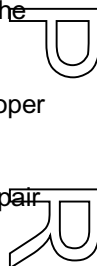

O53,READ2 -19-08JUL85

UN-23AUG88  
TS183

### WEAR PROTECTIVE CLOTHING

Wear fairly tight clothing .... and safety equipment.

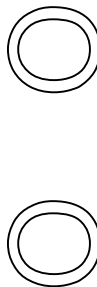

M45,1005A,6 -19-09JAN85

UN-24APR89  
M34583

10  
05  
4

### PROTECT AGAINST NOISE

Prolonged exposure to loud noise can cause impairment or loss of hearing.

Wear a suitable hearing protective device such as earmuffs or earplugs to protect against objectionable or uncomfortable loud noises.



O53,NOISE -19-26JAN90

TS207 -UN-23AUG88

### AVOID HIGH-PRESSURE FLUIDS

Escaping fluid under pressure can penetrate the skin causing serious injury.

Avoid the hazard by relieving pressure before disconnecting hydraulic or other lines. Tighten all connections before applying pressure.

Search for leaks with a piece of cardboard. Protect hands and body from high pressure fluids.

If an accident occurs, see a doctor immediately. Any fluid injected into the skin must be surgically removed within a few hours or gangrene may result. Doctors unfamiliar with this type of injury may call the Deere & Company Medical Department in Moline, Illinois, or other knowledgeable medical source.

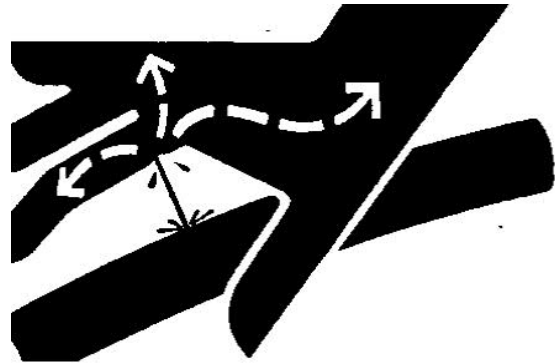

O53,FLUID -19-26JAN90

X9811 -UN-23AUG88



## SERVICE LOADER SAFELY

Do not work under lift arms unless they are resting on lift arm stops.



Before you work on loader or any attached equipment:

- Lower attachments to ground, or
- Rest lift arms on lift arm stops.

Lower lift arms all the way and stop engine before you install or remove attachments.



Before you make repairs or adjustments, stop the engine.



Do not change engine governor settings or overspeed engine.

Keep the loader and attachments in good operating condition.

Keep safety devices in place and in working condition.



Keep all nuts, bolts, and screws tight so equipment is in safe working condition.

Before you work on any part of the engine, stop the engine, and let it cool. Hot engine parts can burn skin on contact.

Do not run engine unless park brake is locked.

Be careful to prevent clothing, jewelry, or long hair from getting caught in the fan blades, belts, or any other moving parts.

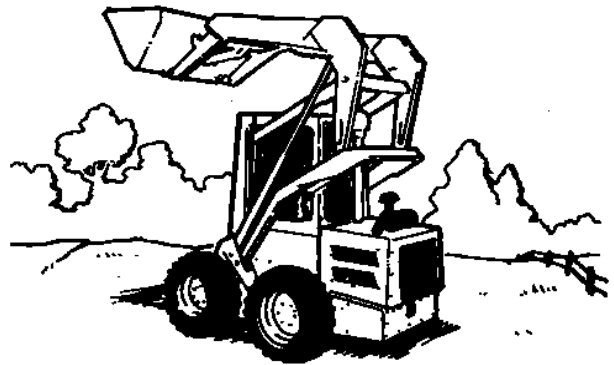

10  
5195  
M38809 -UN-25APR89

M21,SAU,I -19-09SEP85

## PREVENT BATTERY EXPLOSIONS

Battery gas can explode. Keep sparks and flames away from batteries. Use a flashlight to check battery electrolyte level.



Never check battery charge by placing a metal object across the posts. Use a voltmeter or hydrometer.



Always remove grounded (-) battery clamp first and replace it last.

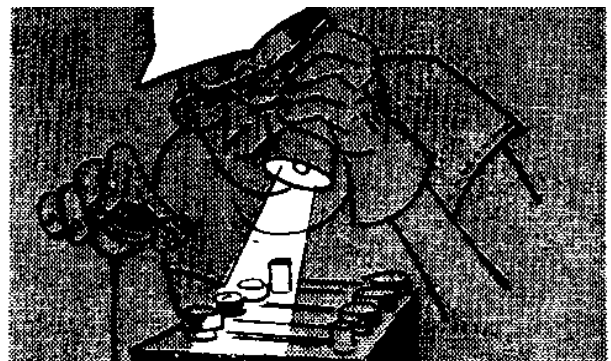

TS181 -UN-23AUG88

O53,EXPLO -19-29JAN86

10  
05  
6

**CAUTION:** Sulfuric acid in battery electrolyte is poisonous. It is strong enough to burn skin, eat holes in clothing, and cause blindness if splashed into eyes.

Avoid the hazard by:

1. Filling batteries in a well-ventilated area.
2. Wearing eye protection and rubber gloves.
3. Avoiding breathing fumes when electrolyte is added.
4. Avoiding spilling or dripping electrolyte.
5. Use proper jump start procedure.

If you spill acid on yourself:

1. Flush your skin with water.
2. Apply baking soda or lime to help neutralize the acid.
3. Flush your eyes with water for 10—15 minutes. Get medical attention immediately.

If acid is swallowed:

1. Drink large amounts of water or milk.
2. Then drink milk of magnesia, beaten eggs, or vegetable oil.
3. Get medical attention immediately.

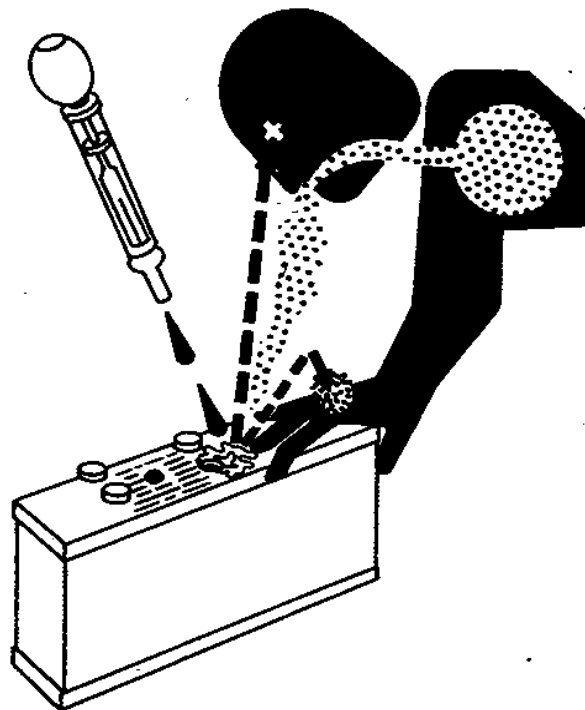

TSS203 -UN-23AUG88

O53.ACID -19-29JAN86

### SERVICE TIRES SAFELY

Failure to follow proper procedures when mounting a tire on a wheel or rim can produce an explosion which may result in serious injury or death. Do not attempt to mount a tire unless you have the proper equipment and experience to perform the job. Have it done by your John Deere dealer or a qualified tire repair service.

When sealing tire beads on rims, never exceed 35 psi (241 kPa) (2.4 bar) or maximum inflation pressures specified by tire manufacturers for mounting tires. Inflation beyond this maximum pressure may break the bead, or even the rim, with dangerous explosive force. If both beads are not seated when the maximum recommended pressure is reached, deflate, reposition tire, relubricate bead and reinflate.



M34163 -UN-25AUG88

10  
05  
7

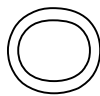
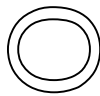
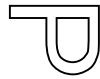
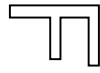
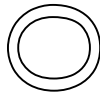
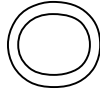
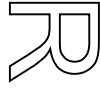

O53,TIRE4 -19-21APR86





**570 SKID-STEER LOADER**

**ENGINE**

Manufacturer		Teledyne Continental
Model		TM13
Cylinders		2
Bore and stroker		3.58 x 4.06 in. (91 x 103.2 mm)
Displacement		81.9 in. <sup>3</sup> (1342 cm <sup>3</sup> )
Fast idle		2800 rpm
Slow idle		1000 rpm
Horsepower		31 at 2800 rpm
Intake valve clearance (cold)		0.014 in. (0.35 mm)
Exhaust valve clearance (cold)		0.018 in. (0.46 mm)
Spark plug		Champion RN9YC
Spark Plug gap		0.035 in. (0.89 mm)
Spark plug torque		30 lb-ft (41 N·m)
Gradability (maximum angle for engine operation on intermittent basis)		45° all directions

**CAPACITIES**

Engine oil with filter		5 qt (4.7 L)
Fuel tank		10 gal (38 L)
Cooling system		6 qt (5.7 L)
Hydraulic system		15 gal (57 L)

**ELECTRICAL SYSTEM**

Battery		12 V, cold cranking capacity: 445 amps at 0°F (-18°C)
Alternator		37 amp
Circuit breaker		20 amp

**HYDROSTATIC TRANSMISSION**

Manufacturer		Cessna
Charge filter		10 micron
Relief pressure		4000 psi (276 bar) (27 580 kPa)
Warning light pressure setting		50 psi (3.5 bar) (350 kPa)

**HYDRAULIC SYSTEM**

Relief pressure		2000 psi (138 bar) (13 790 kPa)
Pump manufacturer		Cessna
Return filter		10 micron
Suction screen		100 mesh
Pump output		8.2 gpm (31 L/min) at 2800 rpm



M21,1010U,A -19-10JUN86



10  
10  
1





  
General Specifications 570 Skid-Steer Loader

10  
10  
2

**LIFT ARM CYLINDERS**

Type		Double-acting
Bore 1-1/2 in. (38 mm)		
Stroke		33 in. (840 mm)
Rod size		1-1/4 in. (32 mm)
Breakout force		1800 lb (816 kg)

**BUCKET CYLINDER**

Type		Double-acting
Bore		3 in. (76 mm)
Stroke		9-1/2 in. (240 mm)
Rod size		1-1/2 in. (38 mm)
Breakout force		1950 lb (885 kg)
Raising time with SAE operating load		4 sec
Dumping time with SAE operating load		1.7 sec
Lowering time empty		2.7 sec
Retract time empty		1.8 sec
Maximum reach		29 in. (740 mm)

**TIRE SIZES AND PRESSURES**

5.70 X 15 (4-ply tubeless)		50 psi (3.5 bar) (350 kPa)
27 x 8.50 x 15 (6-ply tubeless)		40 psi (2.8 bar) (280 kPa)
27 x 10.50 x 15 (6-ply tubeless)		40 psi (2.8 bar) (280 kPa)
Wheel bolt torque		150 lb-ft (200 N·m)



**TRAVEL SPEEDS**

(Forward and Reverse) ..... 0—7.5 mph (11.2 km/h)

**OPERATING WEIGHT**

..... 3340 lb (1515 kg)

**BUCKET CAPACITIES AND WEIGHTS**

Bucket size in. (M)	Struck Capacity cu. ft. (M <sup>3</sup> )		Heaped Capacity cu. ft. (M <sup>3</sup> )	Weight lbs. (kg)
*47 (1.19) utility bucket	8.8 (0.25)		11.0 (0.31)	231 (105)
54 (1.37) dirt and foundry bucket	7.5 (0.21)		9.5 (0.27)	256 (116)
54 (1.37) utility bucket	10.2 (0.29)		12.7 (0.34)	254 (115)
60 (1.52) utility bucket	11.3 (0.32)		14.1 (0.40)	272 (123)
60 (1.52) low profile bucket	6.4 (0.18)		8.4 (0.24)	289 (131)
66 (1.68) light materials bucket	12.5 (0.35)		15.6 (0.44)	298 (135)



\*Use with 5.70 x 15 tires only.

(Specifications and design subject to change without notice.)

M21,1010U.B -19-10OCT86

## 575 SKID-STEER LOADER

### ENGINE

Manufacturer		Yanmar
Model		3TNA82RJL Diesel
Cylinders		3
Bore and stroke		3.23 x 3.39 in. (82 x 86 mm)
Displacement		83.1 in. <sup>3</sup> (1362 cm <sup>3</sup> )
Fast idle		2950 rpm
Slow idle		950 rpm
Horsepower (mfg. rating)		33 at 3600 rpm (24.6 kW)
Operating horsepower		28.7 at 2800 rpm (21.4 kW)
Intake valve clearance (cold)		0.014 in. (0.35 mm)
Exhaust valve clearance (cold)		0.018 in. (0.46 mm)
Gradability (maximum angle for engine operation on intermittent basis)		45° all directions

### CAPACITIES

Engine oil with filter		6.4 qt (6 L)
Fuel tank		10 gal (38 L)
Cooling system		6 qt (5.7 L)
Hydraulic system		15 gal (57 L)

### ELECTRICAL SYSTEM

Battery		12 V, cold cranking capacity: 445 amps at 0°F (-18°C)
Alternator		37 amp
Circuit breaker		20 amp

### HYDROSTATIC TRANSMISSION

Manufacturer		Cessna
Charge filter		10 micron
Relief pressure		4000 psi (276 bar) (27 580 kPa)
Warning light pressure setting		50 psi (3.5 bar) (350 kPa)



### HYDRAULIC SYSTEM

Relief pressure		2000 psi (138 bar) (13 790 kPa)
Pump manufacturer		Cessna
Return filter		10 micron
Suction screen		100 mesh
Pump output		8.2 gpm (31 L/min) at 2800 rpm
Displacement		0.66 cu in. per rev (10.8 cm <sup>3</sup> )

### SAE RATED LOAD LIMIT

1200 LB (544 KG)

### DIMENSIONS—575 Skid-Steer Loader with 54-in. (1372 mm) bucket and 27 x 8.50 x 15 tires

Overall length		116-1/2 in. (2959 mm)
Overall width		54 in. (1372 mm)
Maximum height, bucket raised		126 in. (3200 mm)
Height to top of cab		171-3/4 in. (1822 mm)

M21.1010U.C -19-20MAY86

10  
10  
3