



Bobcat®

316

Service Manual

S/N 522811001 & Above

S/N 522911001 & Above

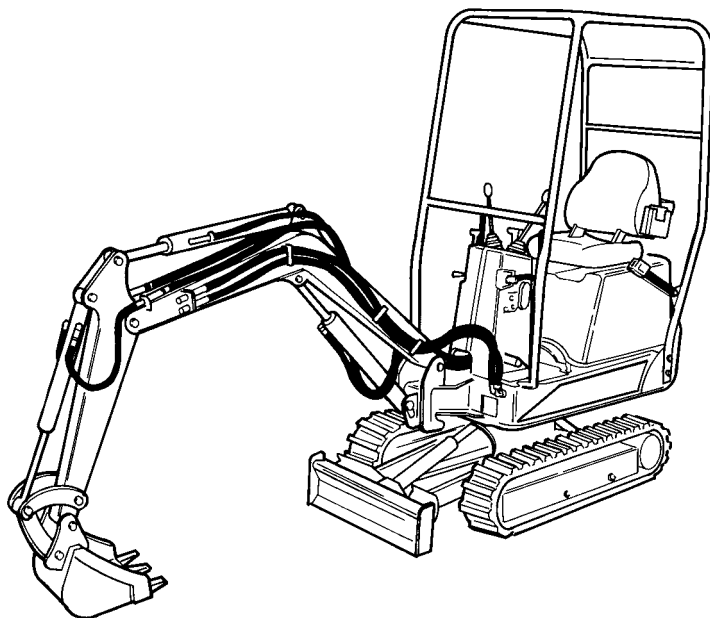

Printed in U.S.A.

© Bobcat Company 2006

MAINTENANCE SAFETY



WARNING

Instructions are necessary before operating or servicing machine. Read and understand the Operation & Maintenance Manual, Operator's Handbook and signs (decals) on machine. Follow warnings and instructions in the manuals when making repairs, adjustments or servicing. Check for correct function after adjustments, repairs or service. Untrained operators and failure to follow instructions can cause injury or death.

W-2003-0903



Safety Alert Symbol: This symbol with a warning statement, means: "Warning, be alert! Your safety is involved!" Carefully read the message that follows.

CORRECT

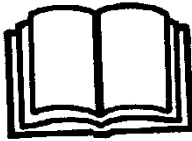

B-10731a

- Never service the Bobcat Hydraulic Excavator without instructions.

CORRECT



B-15797

- Use the correct procedure to lift and support the excavator.
- Always lift the blade fully before installing jackstands.

CORRECT



B-15798

- Cleaning and maintenance are required daily.

WRONG

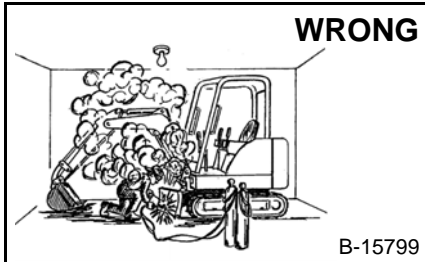

B-15799

- Have good ventilation when welding or grinding painted parts.
- Wear dust mask when grinding painted parts. Toxic dust and gas can be produced.

WRONG

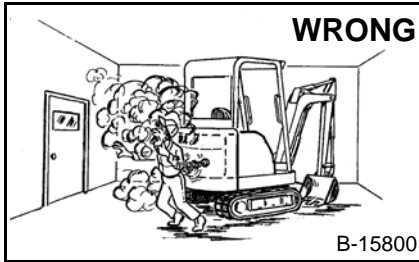

B-15800

- Vent exhaust to outside when engine must be run for service.
- Exhaust system must be tightly sealed. Exhaust Fumes can kill without warning.

WRONG

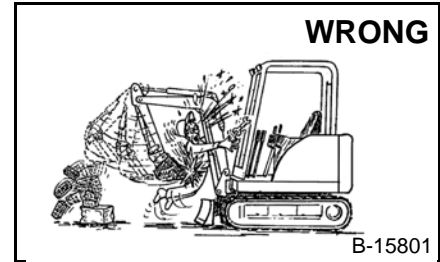

B-15801

- Always lower the bucket and blade to the ground before doing any maintenance.
- Never modify equipment or add attachments not approved by Bobcat Company.

WRONG

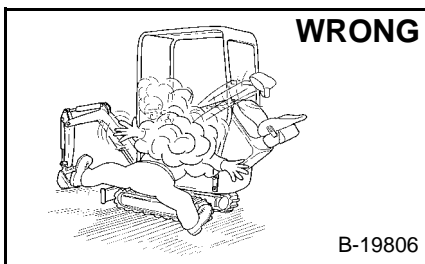

B-19806

- Stop, cool and clean engine of flammable materials before checking fluids.
- Never service or adjust machine with the engine running unless instructed to do so in the manual.
- Avoid contact with leaking hydraulic fluid or diesel fuel under pressure. It can penetrate the skin or eyes.
- Never fill fuel tank with engine running, while smoking or when near open flame.

WRONG

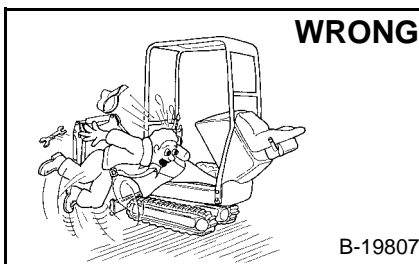

B-19807

- Keep body, jewelry and clothing away from moving parts, electrical contact, hot parts and exhaust.
- Wear eye protection to guard from battery acid, compressed springs, fluids under pressure and flying debris when engines are running or tools are used. Use eye protection approved for type of welding.
- Keep side access covers closed except for service.

WRONG



B-6589

- Lead-acid batteries produce flammable and explosive gases.
- Keep arcs, sparks, flames and lighted tobacco away from batteries.
- Batteries contain acid which burns eyes or skin on contact. Wear protective clothing. If acid contacts body, flush well with water. For eye contact flush well and get immediate medical attention.

Maintenance procedures which are given in the Operation & Maintenance Manual can be performed by the owner/operator without any specific technical training. Maintenance procedures which are **not** in the Operation & Maintenance Manual must be performed **ONLY BY QUALIFIED BOBCAT SERVICE PERSONNEL**. Always use genuine Bobcat replacement parts. The Service Safety Training Course is available from your Bobcat dealer.



Bobcat®

ALPHABETICAL INDEX

AIR CLEANER	10-01, 60-01	INSTRUMENT PANEL	50-01
ALTERNATOR	50-01	ISO HYDRAULIC CONTROL CHANGE.....	20-01
ALTERNATOR BELT	10-01	LIFTING THE EXCAVATOR	10-01
ARM	40-01	LIGHT	50-01
ARM CYLINDER	20-01	LUBRICATING THE EXCAVATOR	10-01
AUXILIARY HYDRAULIC CONTROL VALVE.....	20-01	MAIN RELIEF VALVES.....	20-01
BATTERY	50-01	PORT RELIEF VALVES.....	20-01
BLADE	30-01	RADIATOR	60-01
BLADE CONTROL.....	40-01	REAR BUMPER	40-01
BLADE CYLINDER	20-01	RECONDITIONING THE ENGINE	60-01
BLADE EXTENSION	10-01	SEAT AND SEAT MOUNT	40-01
BOOM	40-01	SERVICE SCHEDULE	10-01
BOOM CYLINDER.....	20-01	SPARK ARRESTOR MUFFLER	10-01, 60-02
BOOM SWING CYLINDER.....	20-01	STANDARD HYDRAULIC CONTROL CHANGE ...	20-01
BOOM OFFSET FRAME	40-01	STARTER	50-01
BUCKET	40-01	SWING BEARING	30-01
BUCKET CYLINDER	20-01	SWING MOTOR	20-01
BUCKET LINK	40-01	SWIVEL JOINT	20-01
CANOPY	40-01	TORQUE SPECIFICATIONS FOR BOLTS	SPEC-01
CONSOLE COVER	40-01	TRACKS	30-01
CONTROL LEVERS AND LINKAGE	40-01	TRACK DAMAGE IDENTIFICATION.....	30-01
CONTROL LOCKOUT	40-01	TRACK FRAME	30-01
CONVERSIONS	SPEC-01	TRACK FRAME EXPANSION CYLINDER	20-01
COOLING SYSTEM	10-01	TRACK FRAME EXPANSION VALVE	20-01
ELECTRICAL SYSTEM INFORMATION	50-01	TRACK IDLER.....	30-01
ENGINE	60-01	TRACK ROLLER	30-01
ENGINE COMPONENTS AND TESTING	60-01	TRANSPORTING THE EXCAVATOR.....	10-01
ENGINE COVER	10-01, 40-01	TRAVEL CONTROLS	40-01
ENGINE FLYWHEEL.....	60-01	TRAVEL MOTOR.....	10-01, 20-01
ENGINE LUBRICATION SYSTEM.....	10-01	TROUBLESHOOTING	60-02
ENGINE SPECIFICATIONS.....	SPEC-01	UPPERSTRUCTURE	40-01
ENGINE SPEED CONTROL	40-01	UPPERSTRUCTURE COVER	40-01
EXCAVATOR SPECIFICATIONS	SPEC-01	UPPERSTRUCTURE SLEW LOCK.....	10-01, 40-01
FOOT CONTROL PEDALS AND LINKAGE	40-01	VOLTAGE REGULATOR	50-01
FUEL, COOLANT AND LUBRICANTS	SPEC-01		
FUEL SYSTEM	10-01		
FUEL TANK.....	40-01		
HORN	40-01		
HYDRAULIC CONNECTION SPECIFICATIONS ..	SPEC-01		
HYDRAULIC CONTROL VALVE.....	20-01		
HYDRAULIC FILTER MOUNT	20-01		
HYDRAULIC FLUID SPECIFICATIONS	SPEC-01		
HYDRAULIC PUMP.....	20-01		
HYDRAULIC RESERVOIR	20-01		
HYDRAULIC SYSTEM	10-01		
HYDRAULIC SYSTEM INFORMATION	20-01		



Bobcat®

CONTENTS

FOREWORD	III
SAFETY INSTRUCTIONS	V
SERIAL NUMBER LOCATIONS	IX
IDENTIFICATION AND MACHINE SIGNS (DECALS)	X
SAFETY AND MAINTENANCE	10-1
HYDRAULIC SYSTEM	20-1
UNDERCARRIAGE	30-1
UPPERSTRUCTURE & SWING SECTION	40-1
ELECTRICAL SYSTEM	50-1
ENGINE SERVICE	60-1
SPECIFICATIONS	SPEC-1

**SAFETY &
MAINTENANCE**

**HYDRAULIC
SYSTEM**

UNDERCARRIAGE

**UPPERSTRUCTURE
& SWING
SECTION**

**ELECTRICAL
SYSTEM**

**ENGINE
SERVICE**

SPECIFICATIONS



Bobcat®

FOREWORD

This manual is for the Bobcat Hydraulic excavator mechanic. It provides necessary servicing and adjustment procedures for the hydraulic excavator and its component parts and systems. Refer to the Operation & Maintenance Manual for operating instructions, starting procedure, daily checks, etc.

A general inspection of the following items must be made after the hydraulic excavator has had service or repair:

1. Check that the ROPS/TOPS/FOGS is in good condition and is not modified.



2. Check that ROPS/TOPS mounting hardware is tightened and is Bobcat approved.

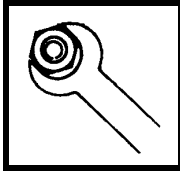

3. The seat belt must be correctly installed, functional and in good condition.

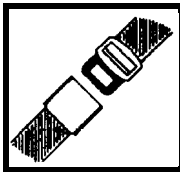

4. Inspect for loose or broken parts or connections.

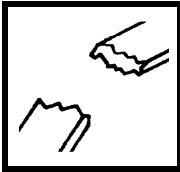

5. Machine signs must be legible and in the correct location.



6. Steering levers, control levers and foot pedals must return to neutral. Check that foot pedals lock and control lever locks are in working order.

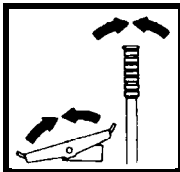

7. Inspect the air cleaner for damage or leaks. Check the condition of the element.

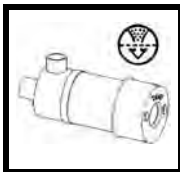

8. Check the electrical charging system.

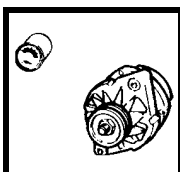

9. Safety treads must be in good condition.

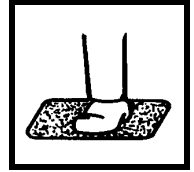

10. Check for correct function of indicator lamps (Optional on some models).

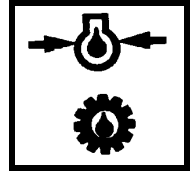

11. Check hydraulic fluid level, engine oil level and fuel supply.

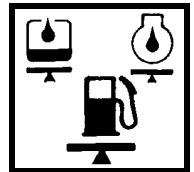

12. Inspect for fuel, oil or hydraulic fluid leaks.

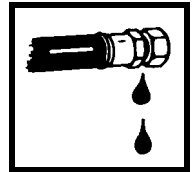

13. Lubricate the excavator.

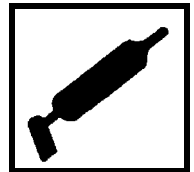

14. Check the condition of the battery and cables.

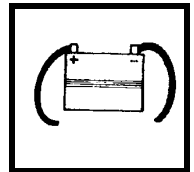

Recommend to the owner that all necessary corrections be made before the machine is returned to service.

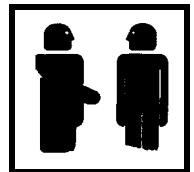

CALIFORNIA PROPOSITION 65 WARNING
 Diesel engine exhaust and some of its constituents are known to the State of California to cause cancer, birth defects and other reproductive harm.



Bobcat®

SAFETY INSTRUCTIONS



Safety Alert Symbol

This symbol with a warning statement means:
“Warning, be alert! Your safety is involved!”
Carefully read the message that follows.



WARNING

Instructions are necessary before operating or servicing machine. Read and understand the Operation & Maintenance Manual, Operator's Handbook and signs (decals) on machine. Follow warnings and instructions in the manuals when making repairs, adjustments or servicing. Check for correct function after adjustments, repairs or service. Untrained operators and failure to follow instructions can cause injury or death.

W-2003-0903



WARNING

Warnings on the machine and in the manuals are for your safety. Failure to obey warnings can cause injury or death.

W-2044-1285

IMPORTANT

This notice identifies procedures which must be followed to avoid damage to the machine.

I-2019-0284

The following publications provide information on the safe use and maintenance of the Bobcat machine and attachments:

- The Delivery Report is used to assure that complete instructions have been given to the new owner and that the machine is in safe operating condition.
- The Operation & Maintenance Manual delivered with the machine or attachment contains operating information as well as routine maintenance and service procedures. It is a part of the machine and can be stored in a container provided on the machine. Replacement Operation & Maintenance Manuals can be ordered from your Bobcat dealer.
- Machine signs (decals) instruct on the safe operation and care of your Bobcat machine or attachment. The signs and their locations are shown in the Operation & Maintenance Manual. Replacement signs are available from your Bobcat dealer.
- An Operator's Handbook fastened to the operator cab. It's brief instructions are convenient to the operator. The handbook is available from your dealer in an English edition or one of many other languages. See your Bobcat dealer for more information on translated versions.
- The AEM Safety Manual delivered with the machine gives general safety information.
- The Service Manual and Parts Manual are available from your dealer for use by mechanics to do shop-type service and repair work.
- The Compact Excavator Operator Training Course is available through your local dealer or at www.training.bobcat.com or www.bobcat.com. This course is intended to provide rules and practices of correct operation of the Bobcat Excavator. The course is available in English and Spanish versions.
- Service Safety Training Courses are available from your Bobcat dealer or at www.training.bobcat.com or www.bobcat.com. They provide information for safe and correct service procedures.
- The Bobcat Compact Excavator Safety Video is available from your Bobcat dealer or at www.training.bobcat.com or www.bobcat.com.

SI EXC-0206 SM

316 Excavator
Service Manual

Dear

**Thanks very much for your visiting and
patience.**

Want to get more information,

Please click here, Go back to the page.

**After your payment, you will have instant access to
your download.**

The Download Link will also be sent to your e-mail.

You will get the complete manual

Have any questions

please write to me

admin@servicemanualperfect.com